

INDIVIDUAL DESIGNS

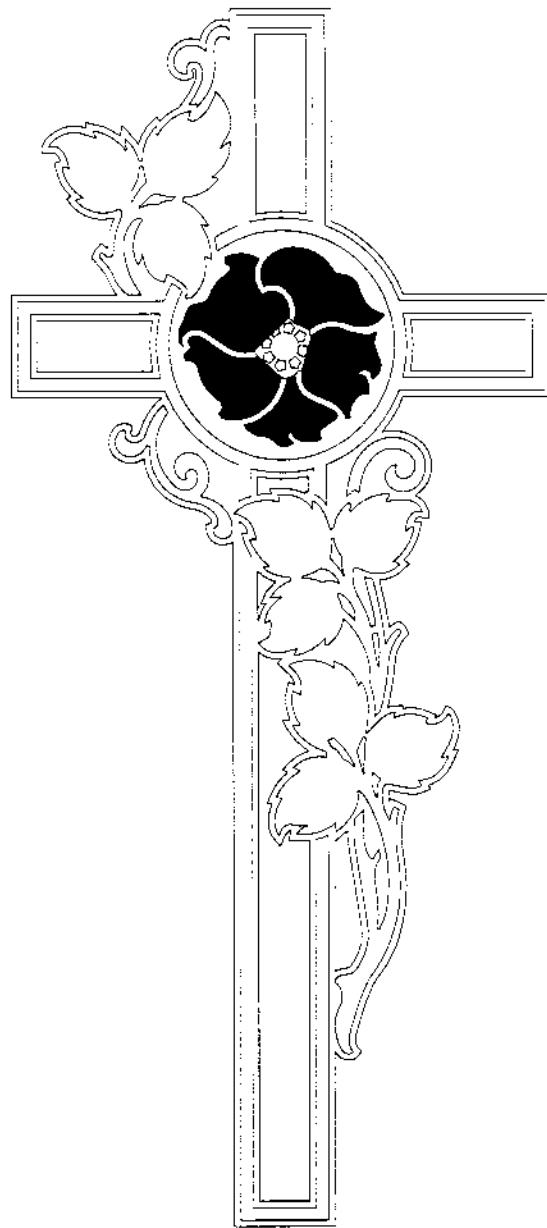

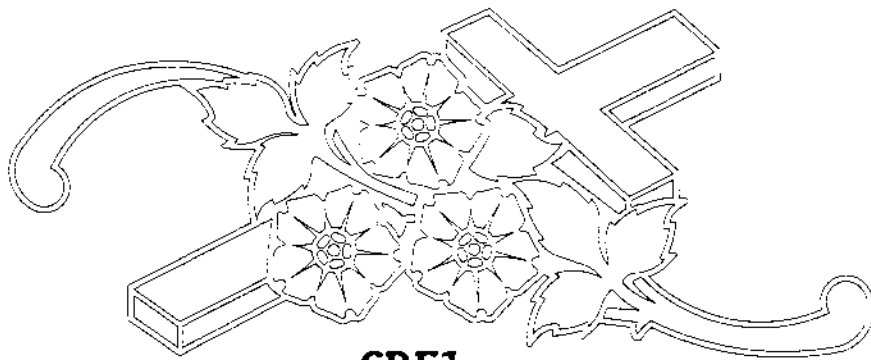

CRF1

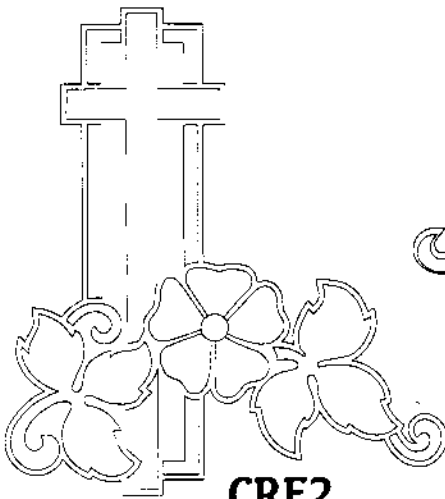

CRF2

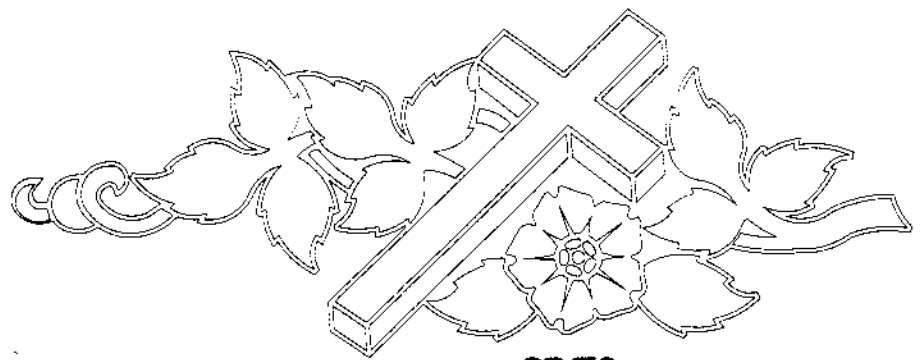

CRF3

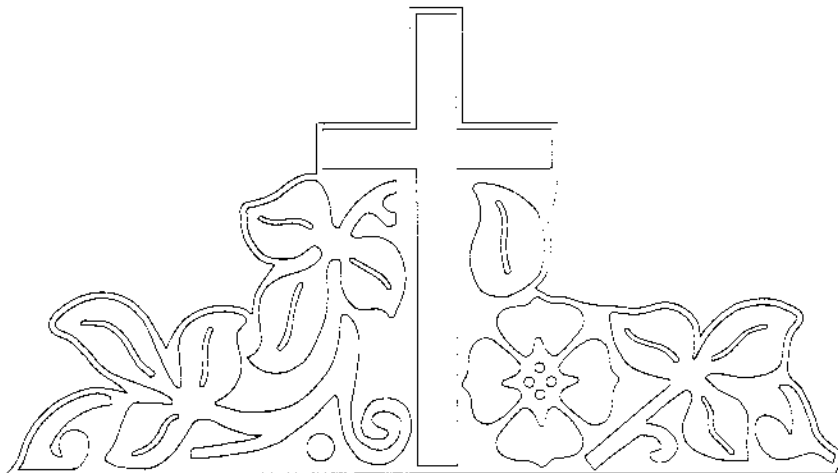

CRF4

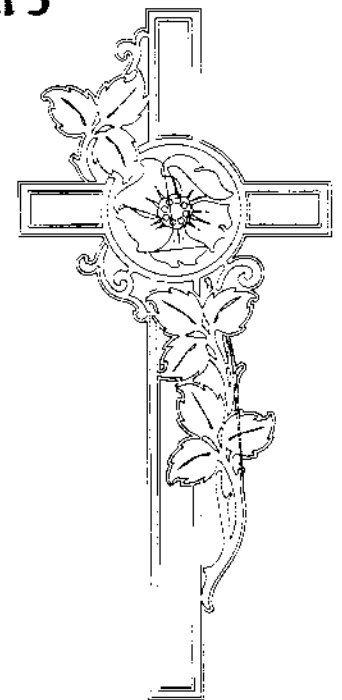

CRF5

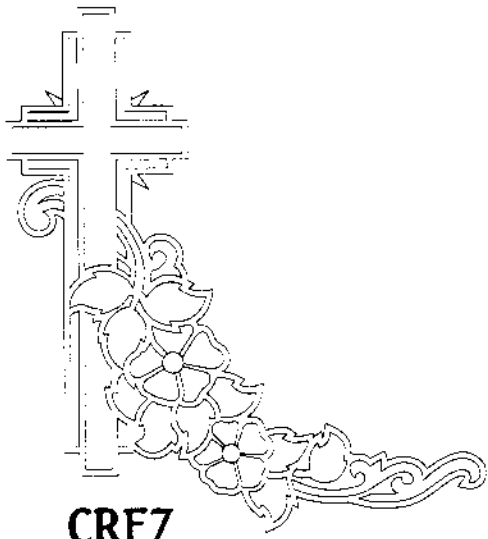

CRF7

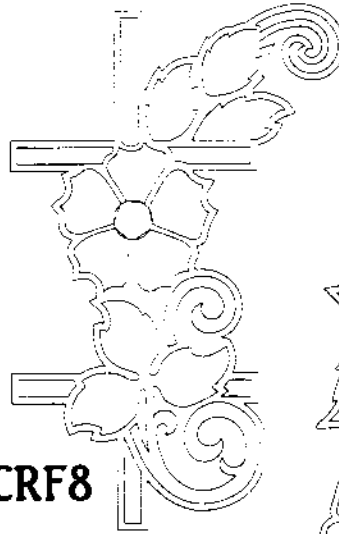

CRF8

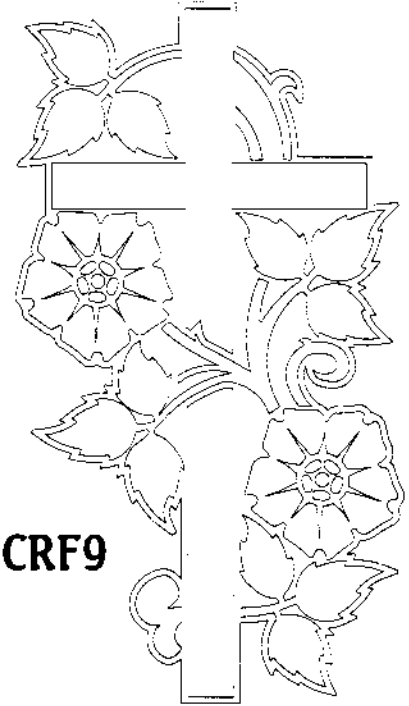

CRF9

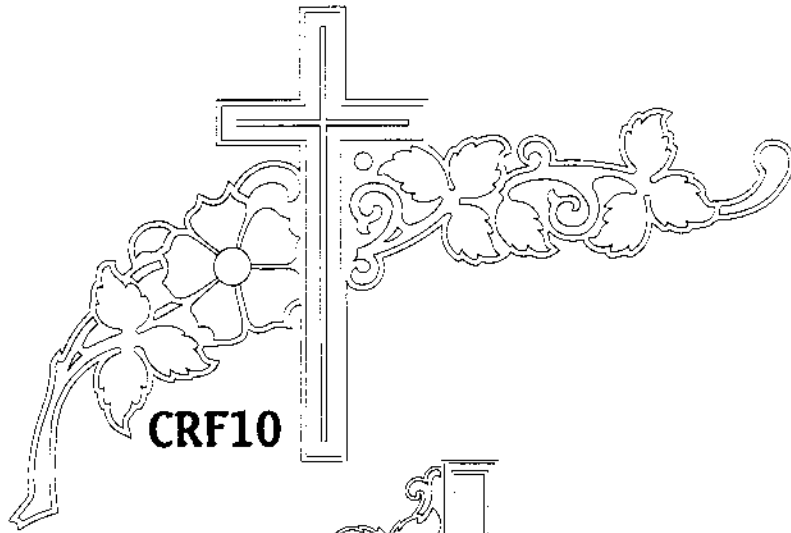

CRF10

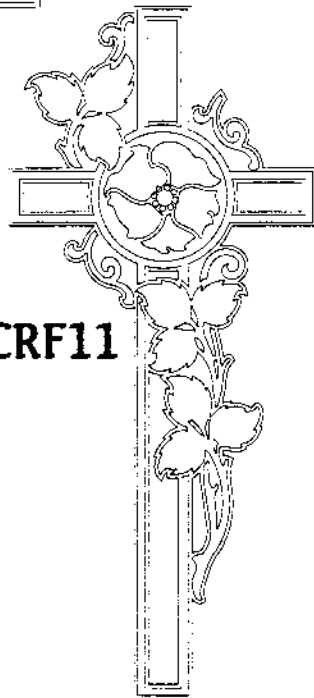

CRF11

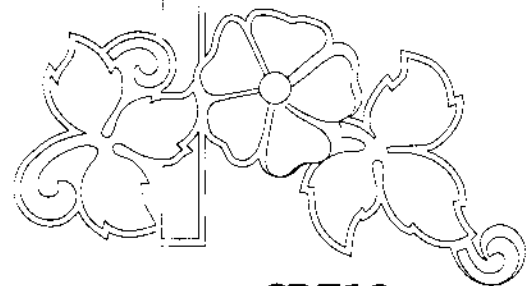
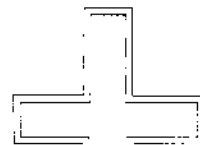

CRF12

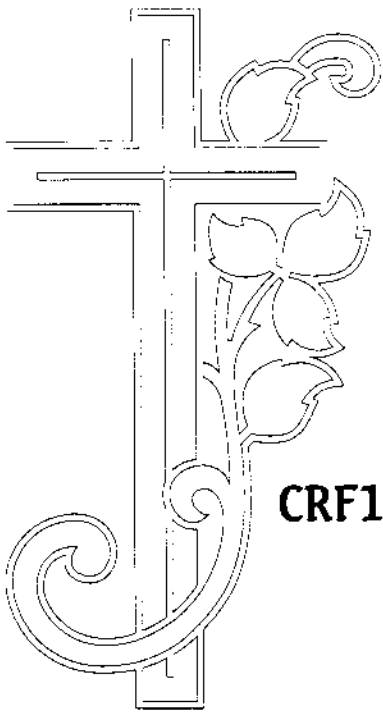

CRF14

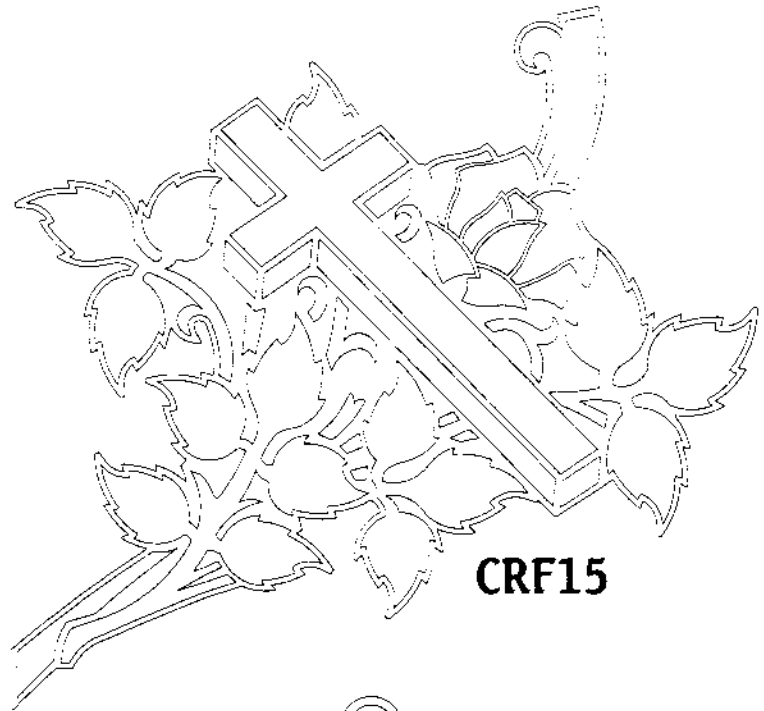

CRF15

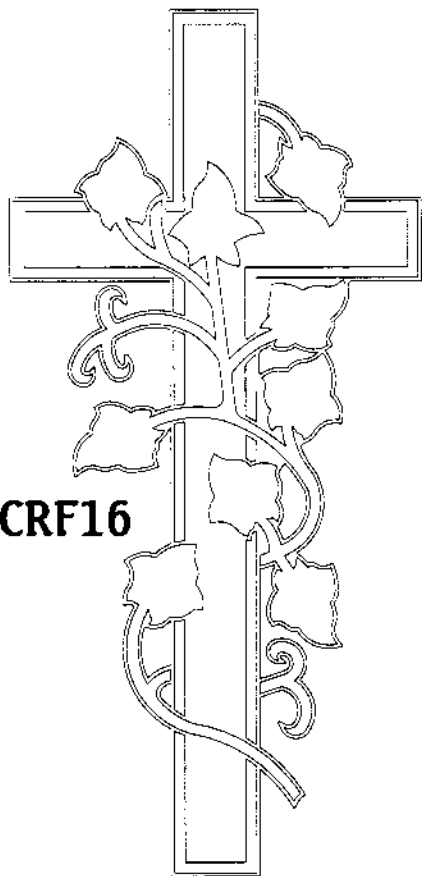

CRF16

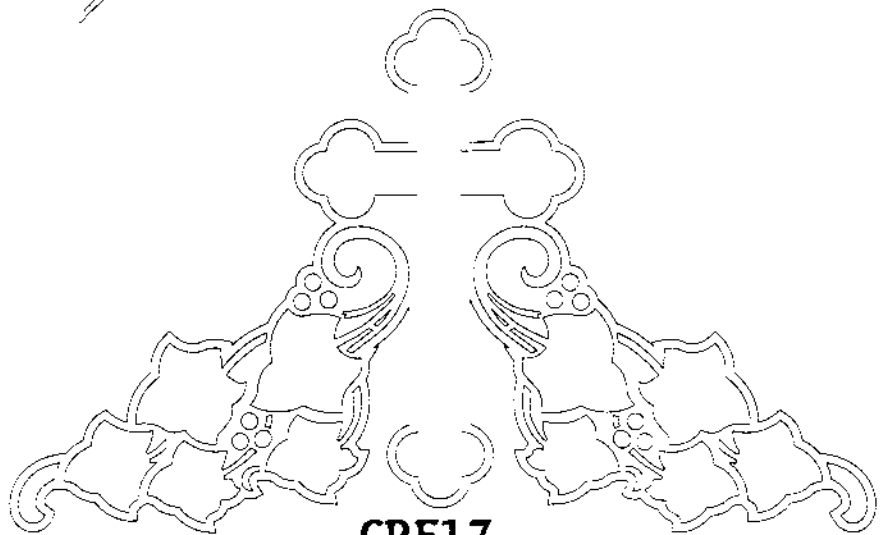

CRF17

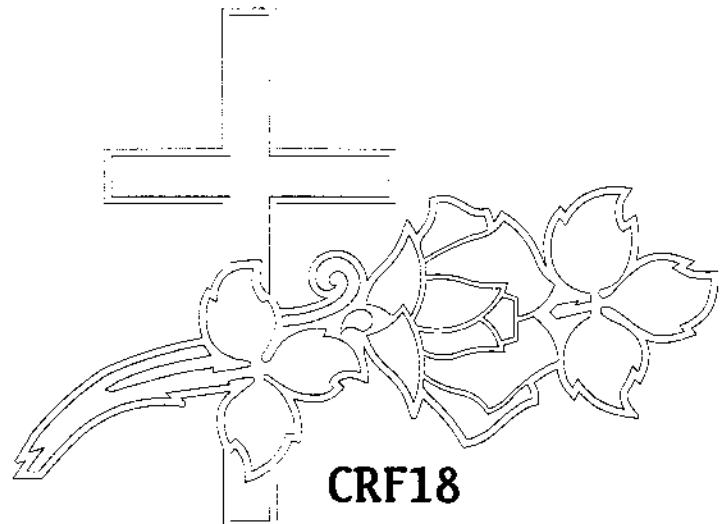

CRF18

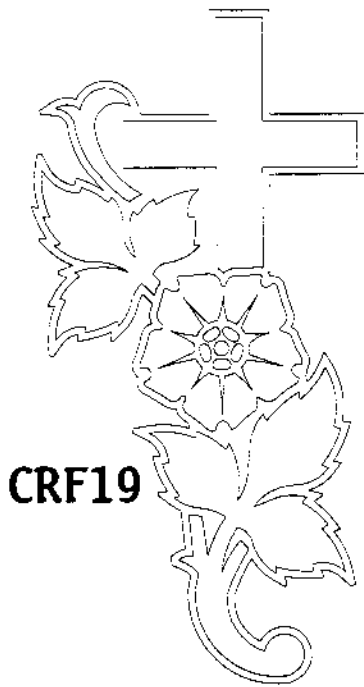

CRF19

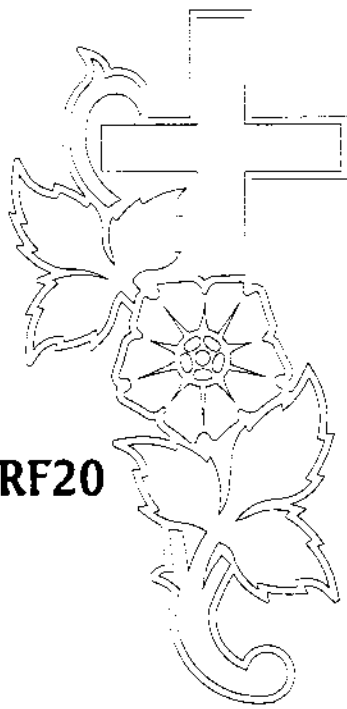

CRF20

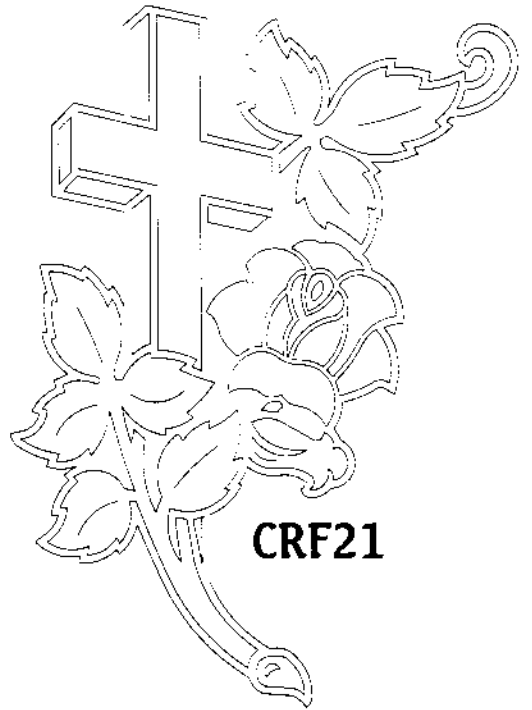

CRF21

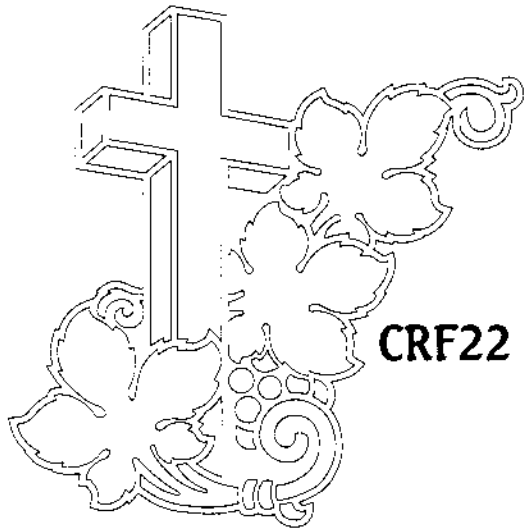

CRF22

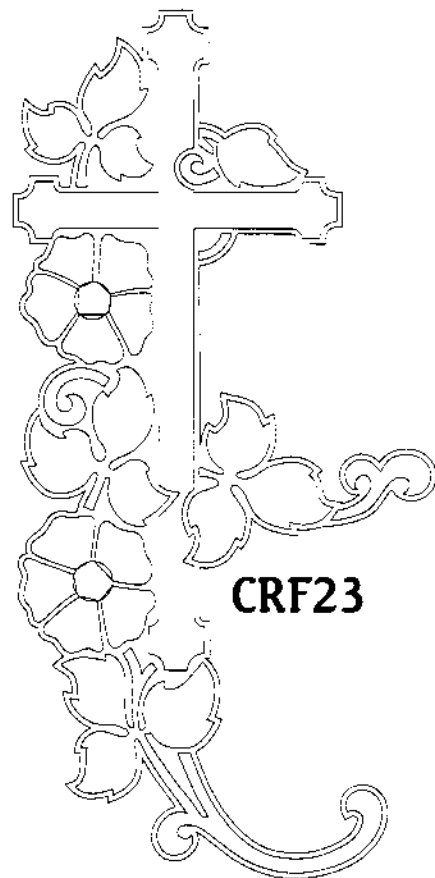

CRF23

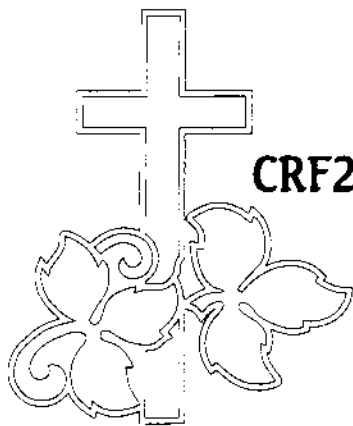

CRF24

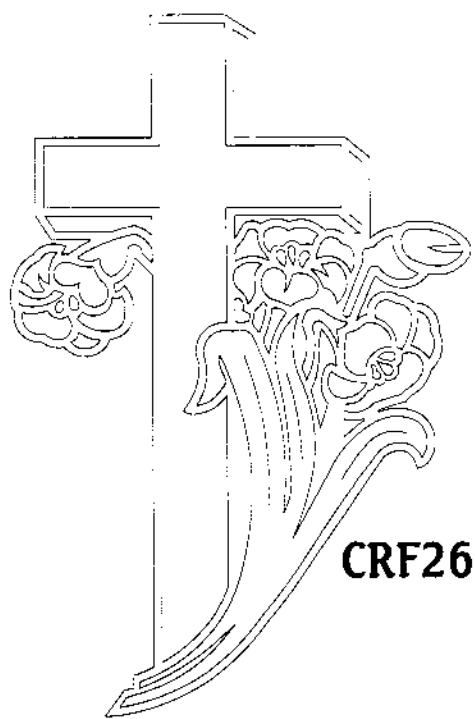

CRF26

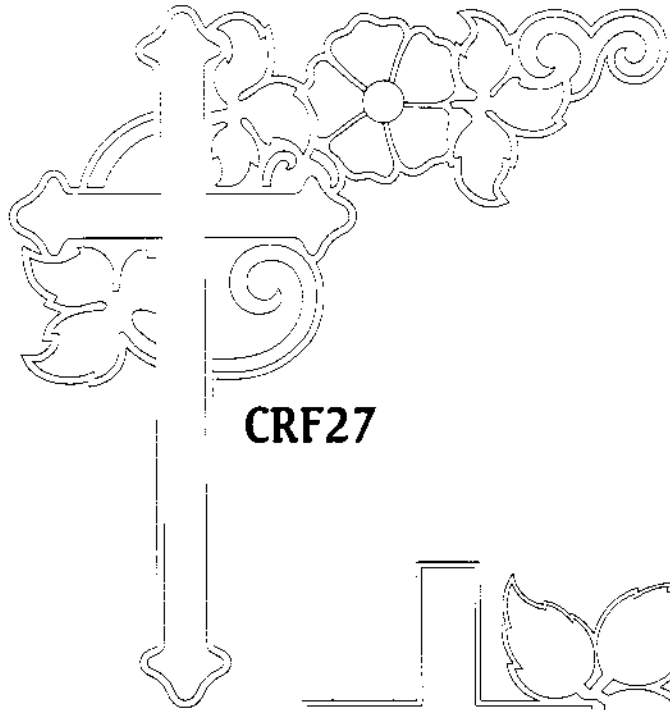

CRF27

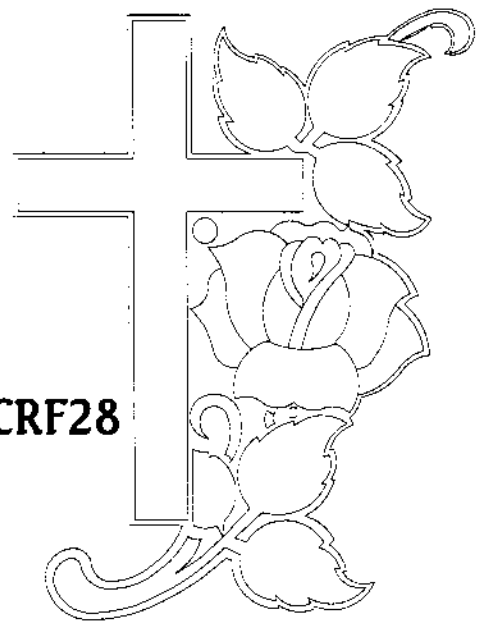

CRF28

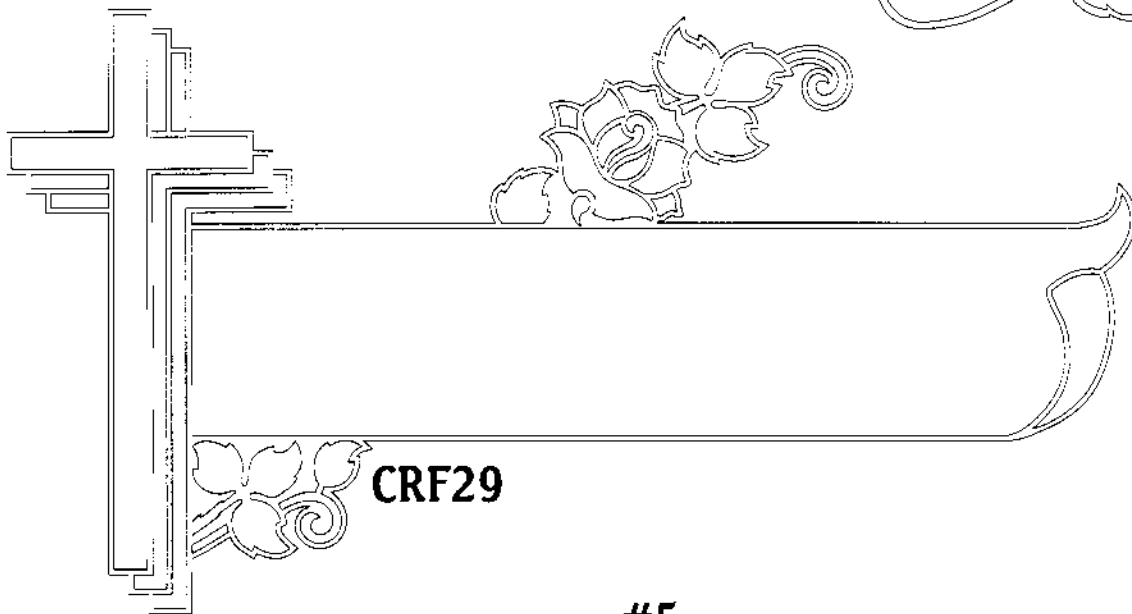

CRF29

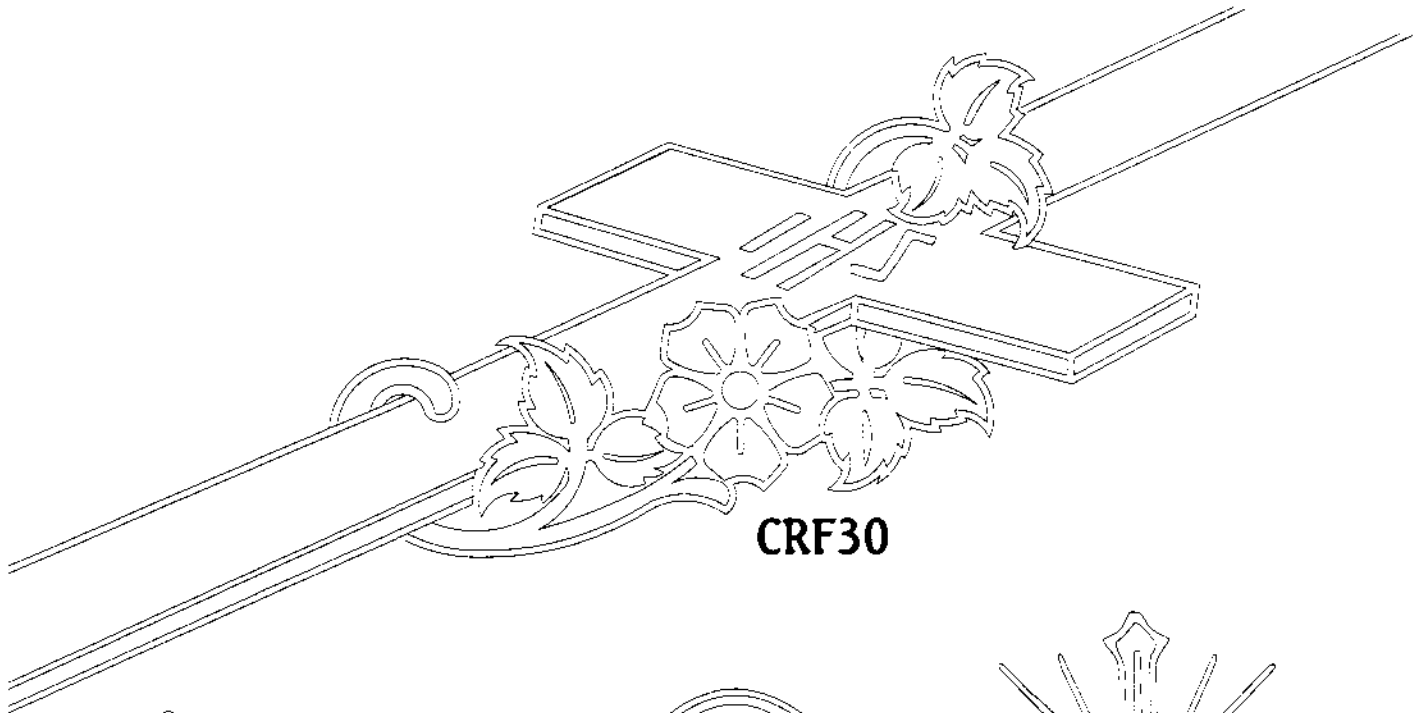

CRF30

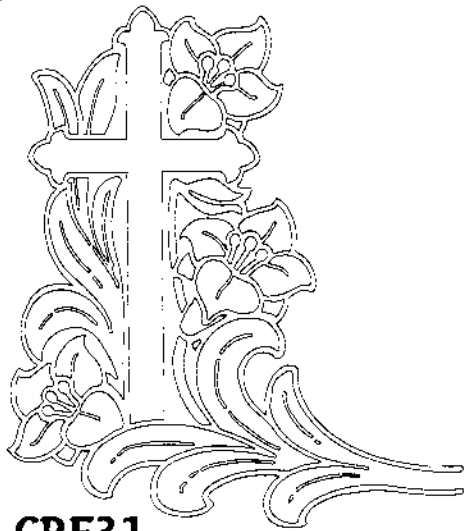

CRF31

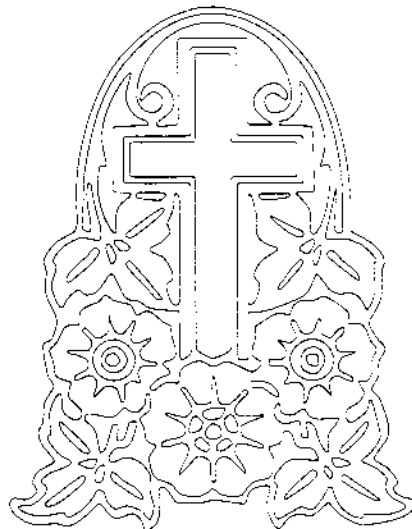

CRF32

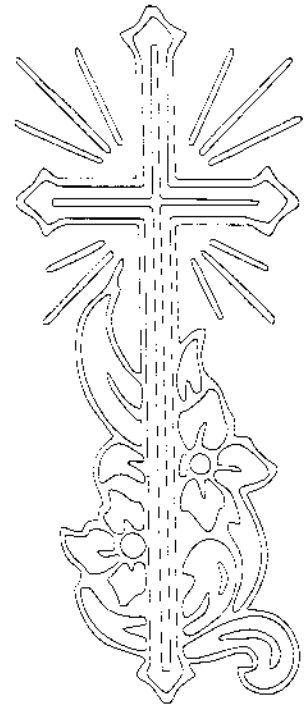

CRF33

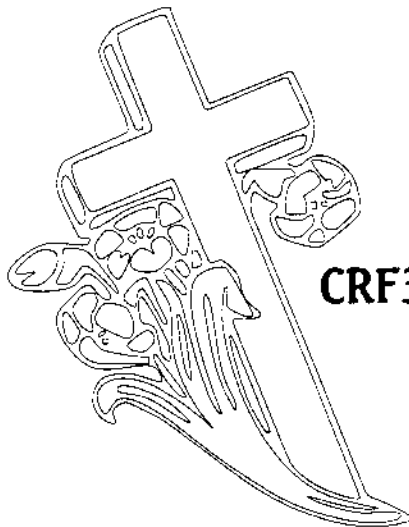

CRF34



CRF35

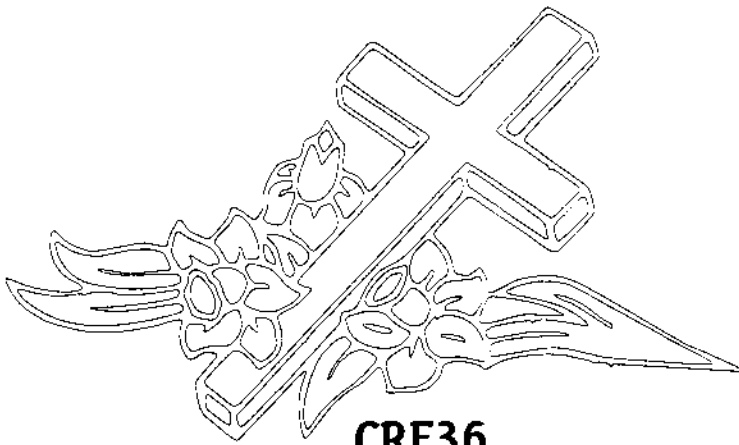

CRF36

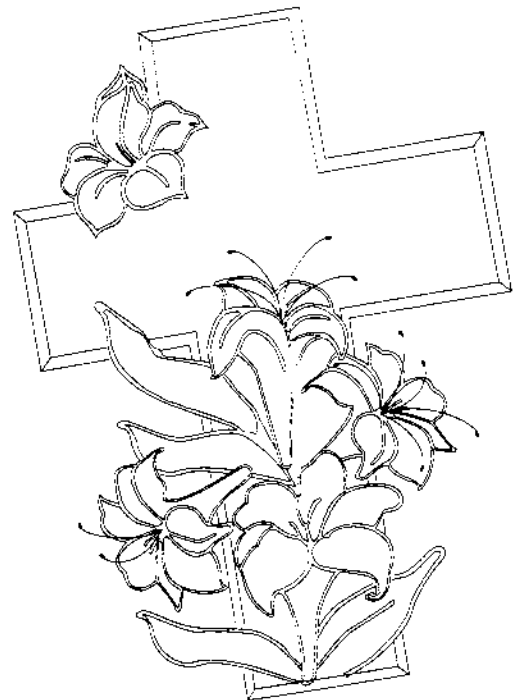

CRF37

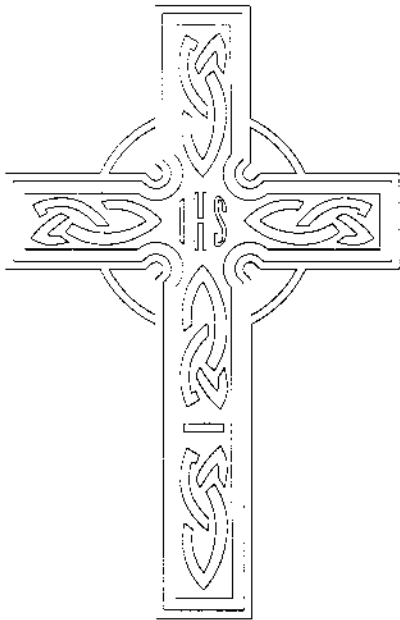

CRCEL1

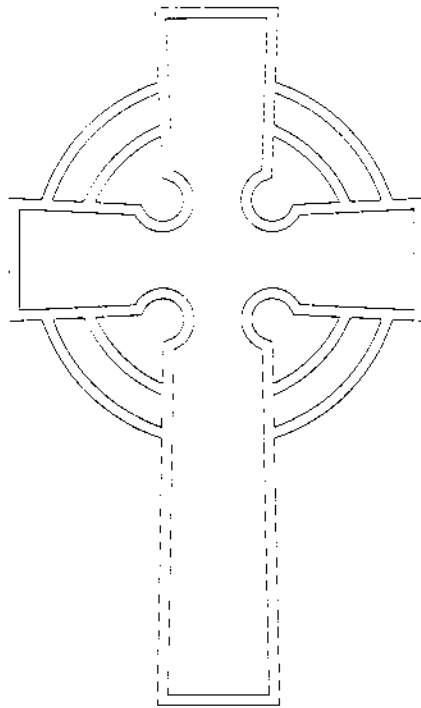

CRCEL2

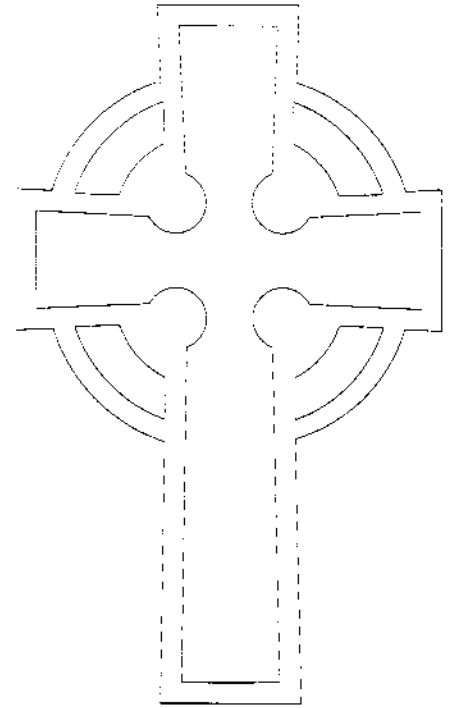

CRCEL3

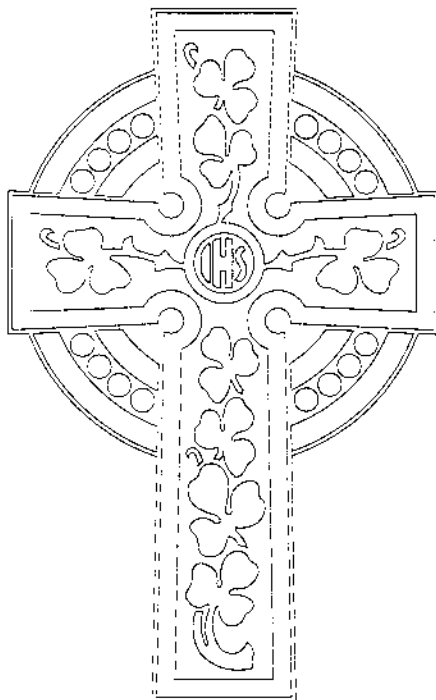

CRCEL4

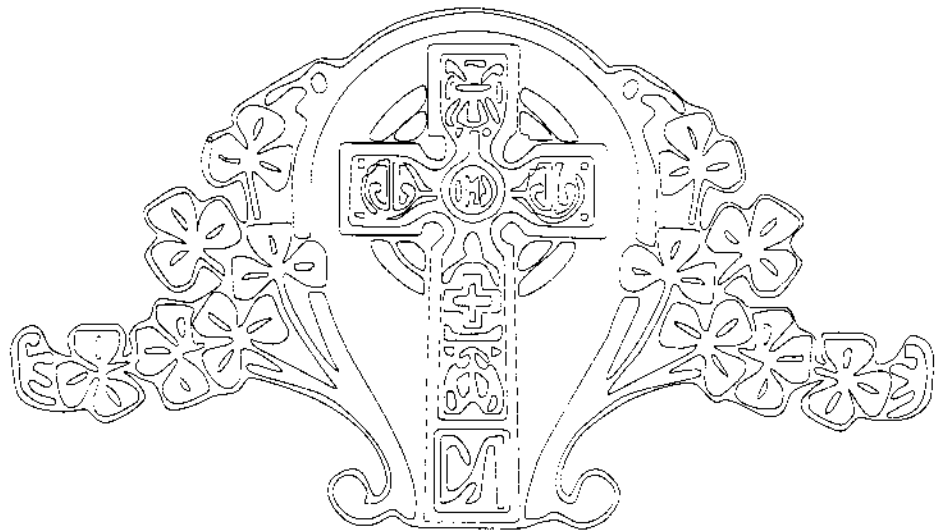

CRCEL5

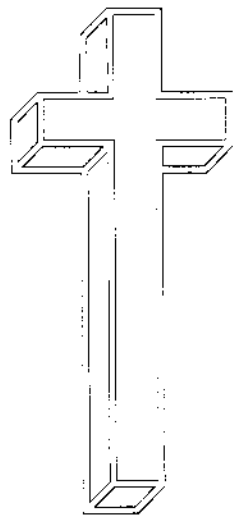

CR1

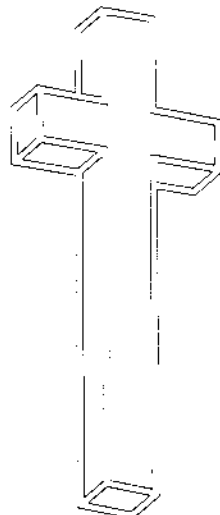

CR2

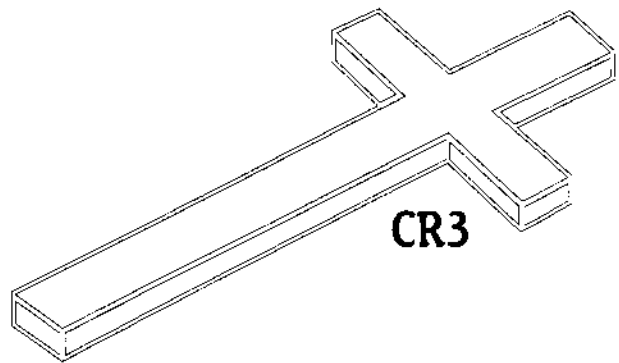

CR3

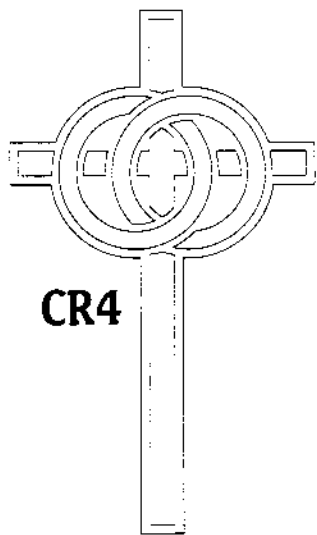

CR4

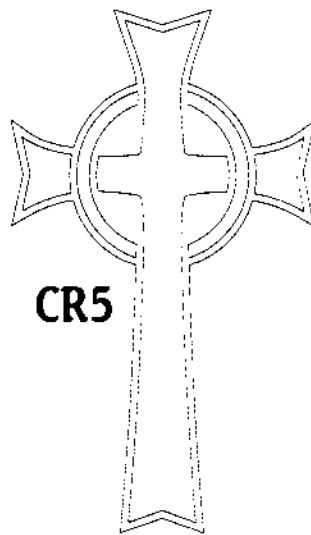

CR5

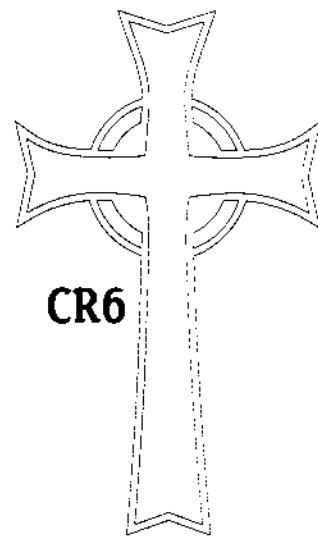

CR6

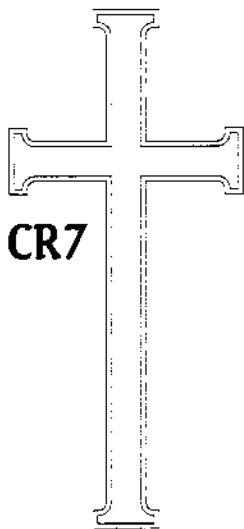

CR7

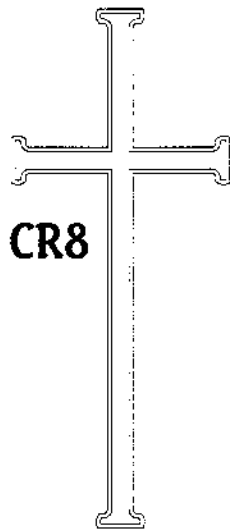

CR8

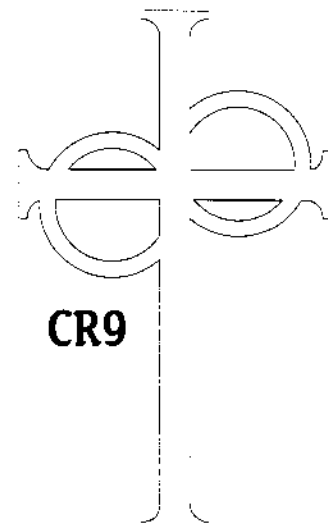

CR9

#1

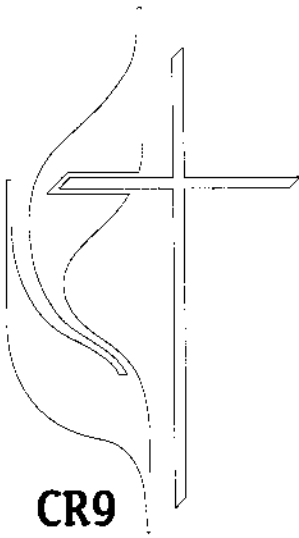

CR9

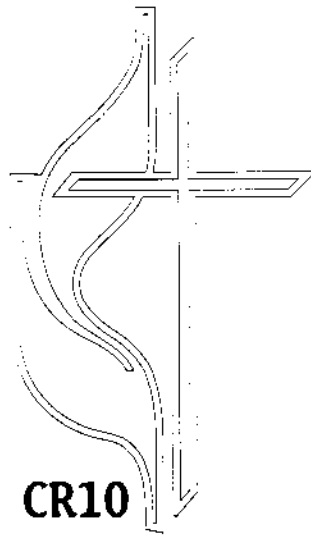

CR10

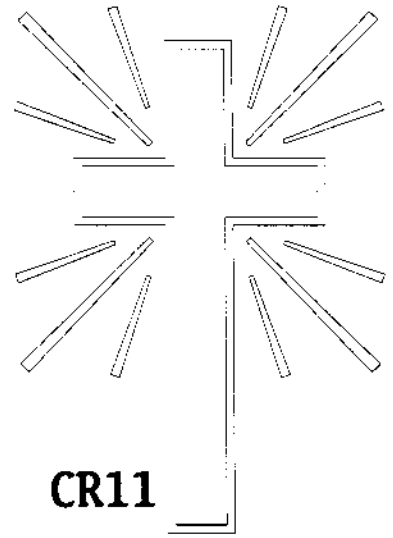

CR11

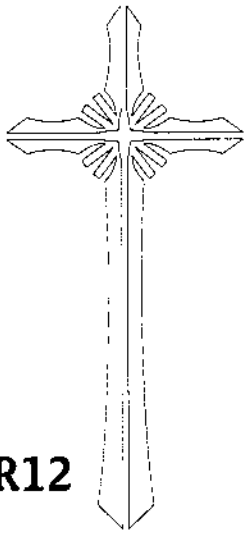

CR12

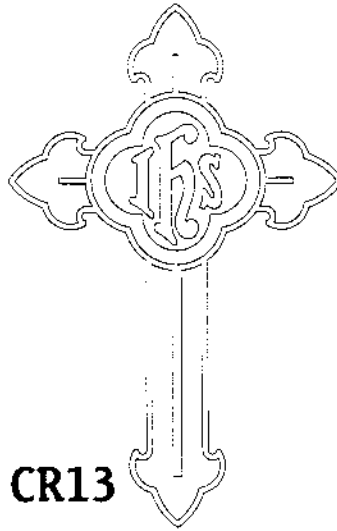

CR13

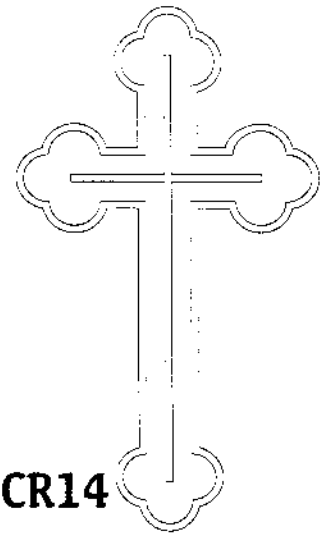

CR14

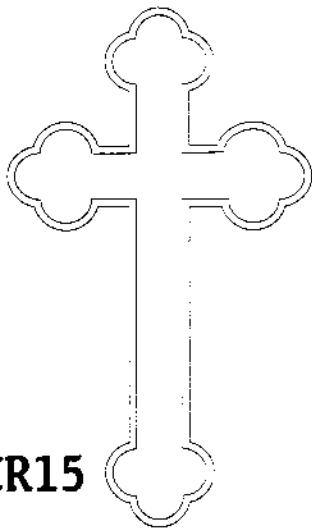

CR15

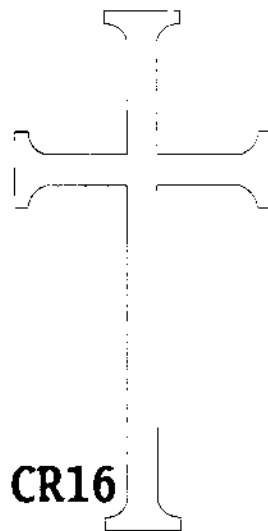

CR16

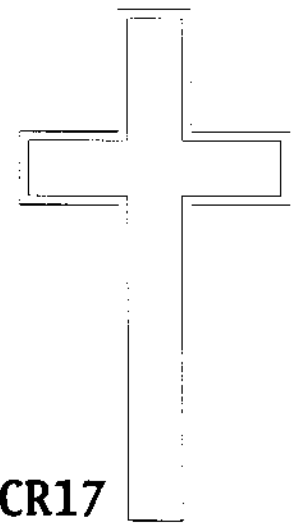

CR17

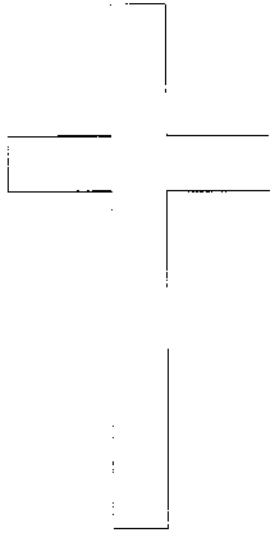

CR18



CR19

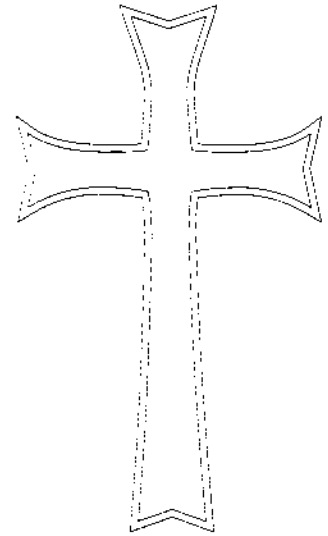

CR20

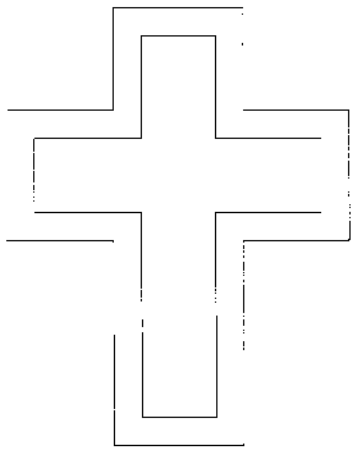

CR21

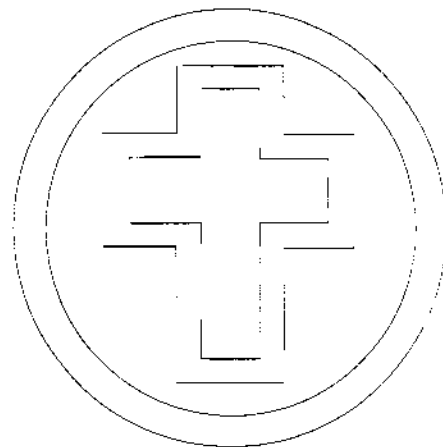

CR22

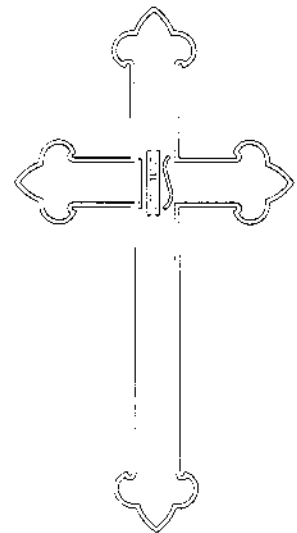

CR23

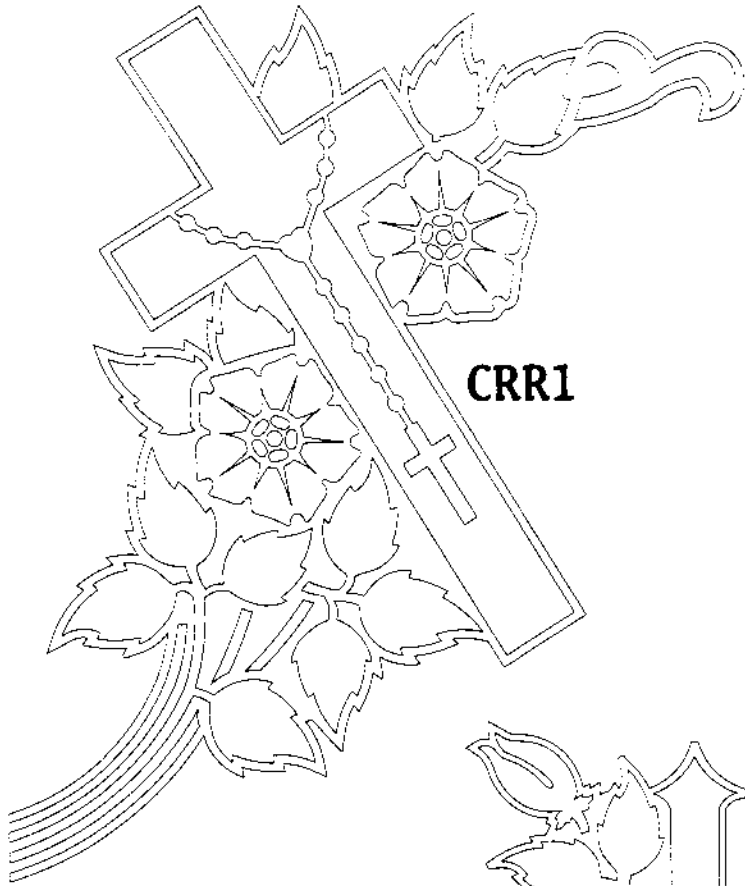

CRR1

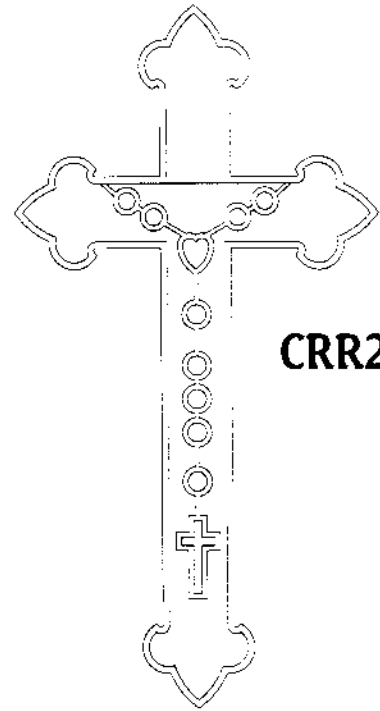

CRR2

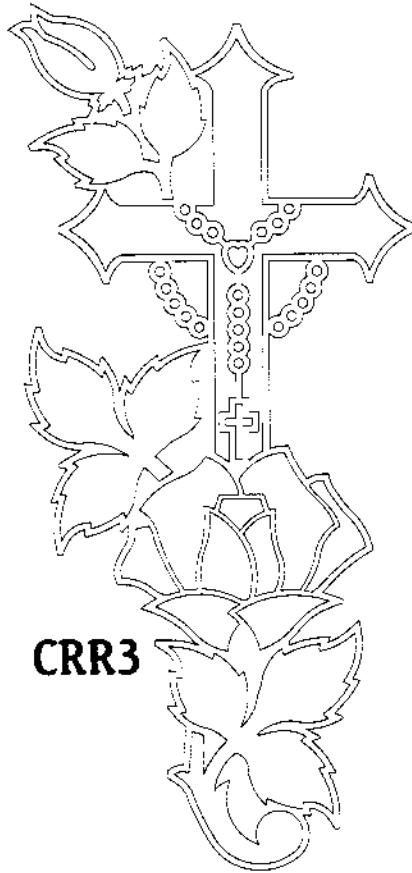

CRR3

#1

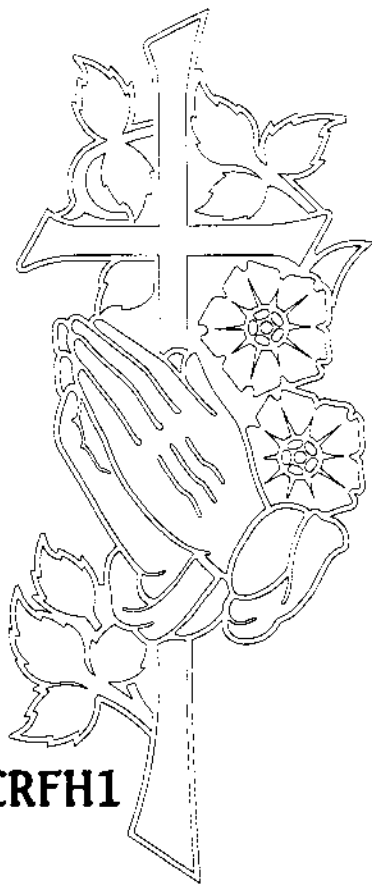

CRFH1

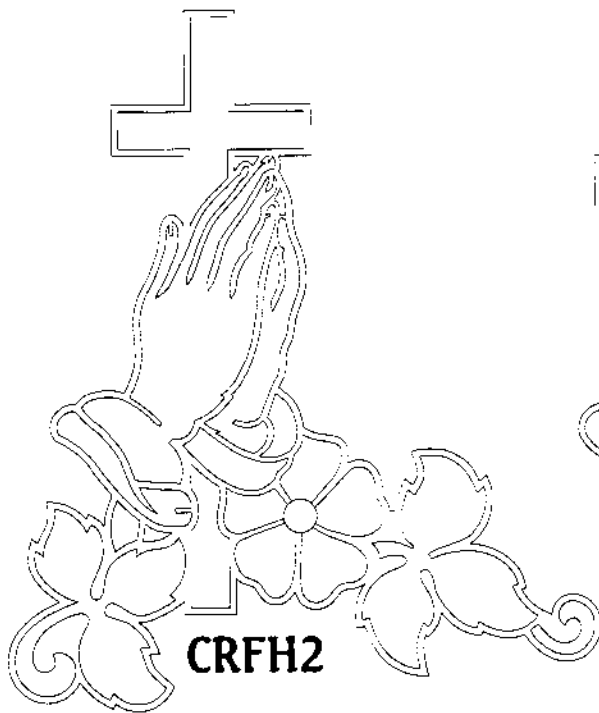

CRFH2

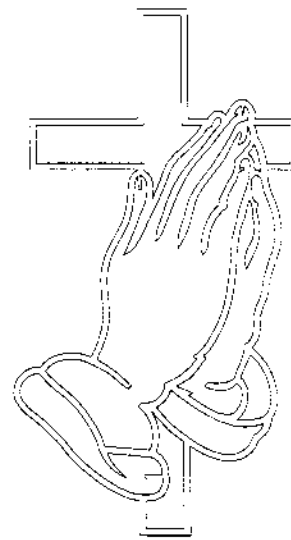

CRH3

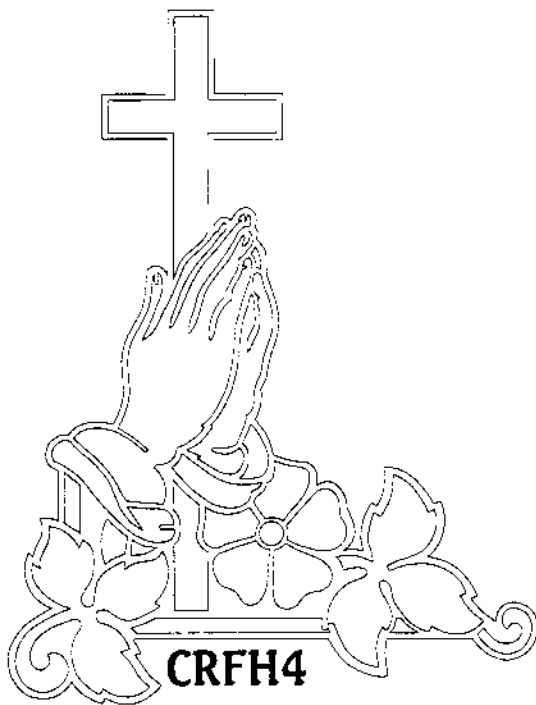

CRFH4

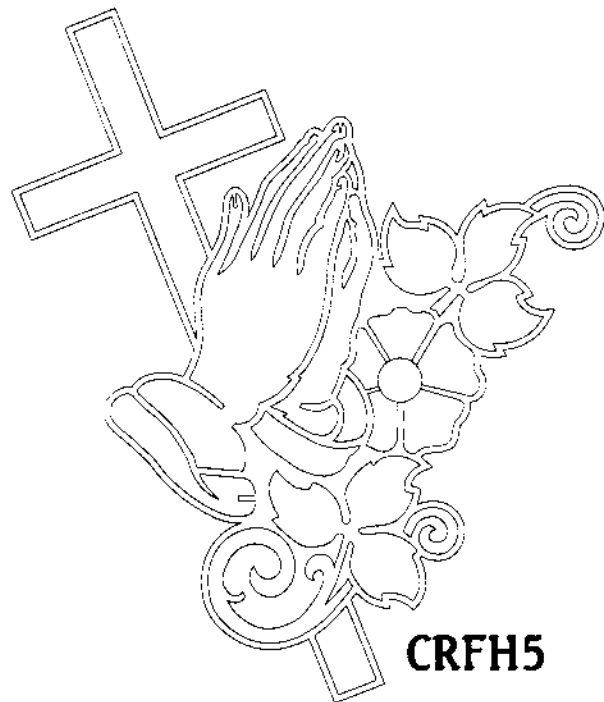

CRFH5

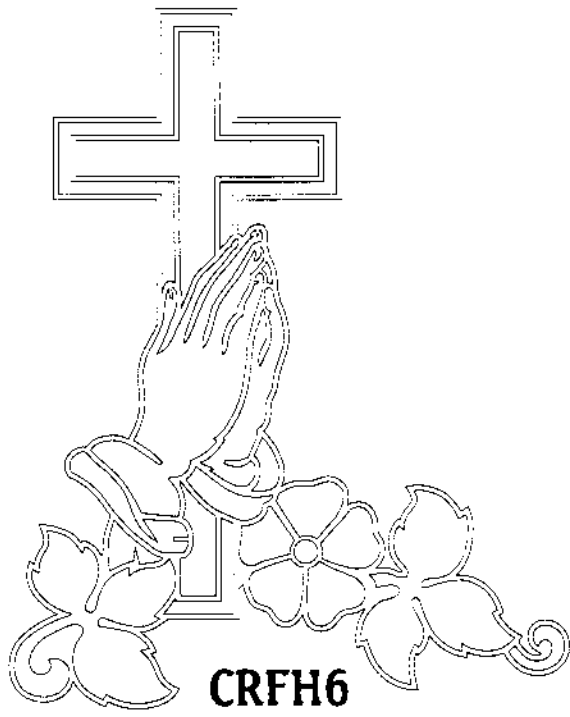

CRFH6

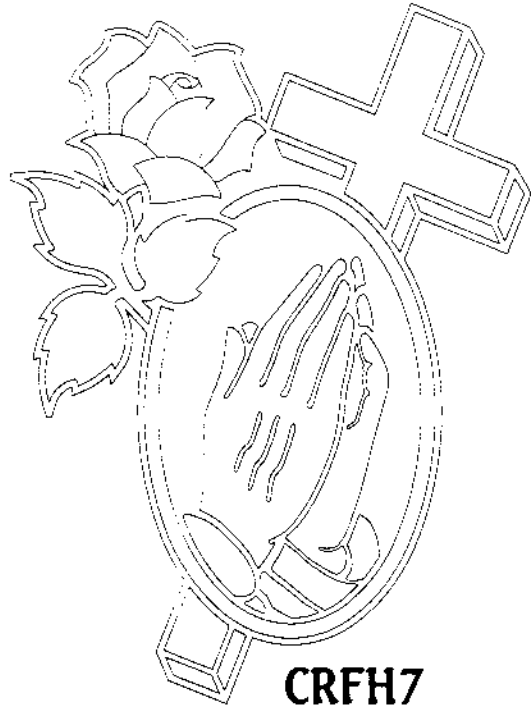

CRFH7

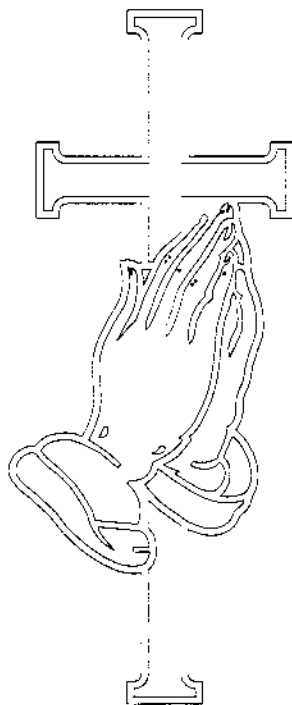

CRH8

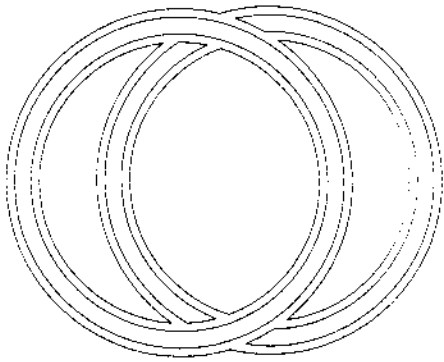

R11

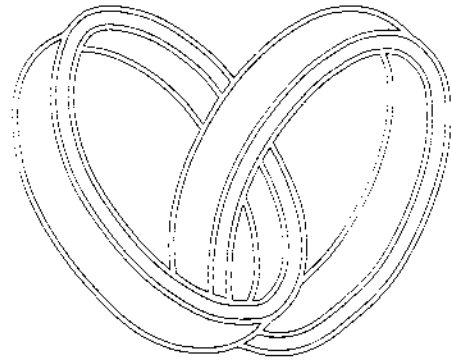

R12

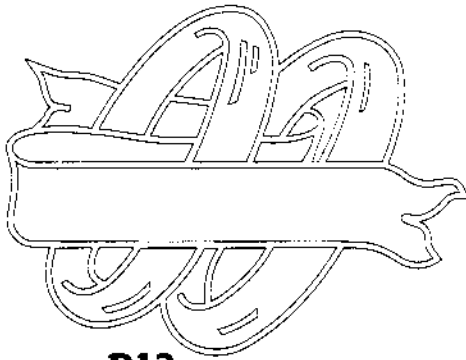

R13

R14

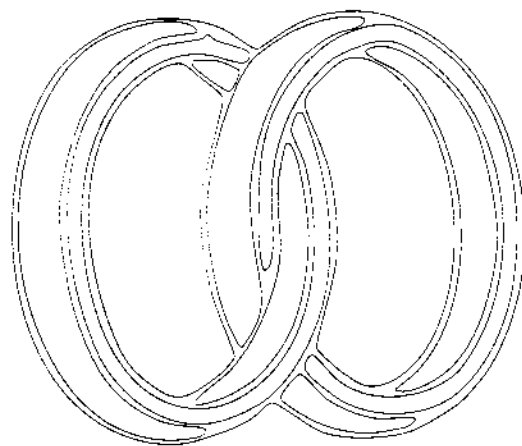

R15

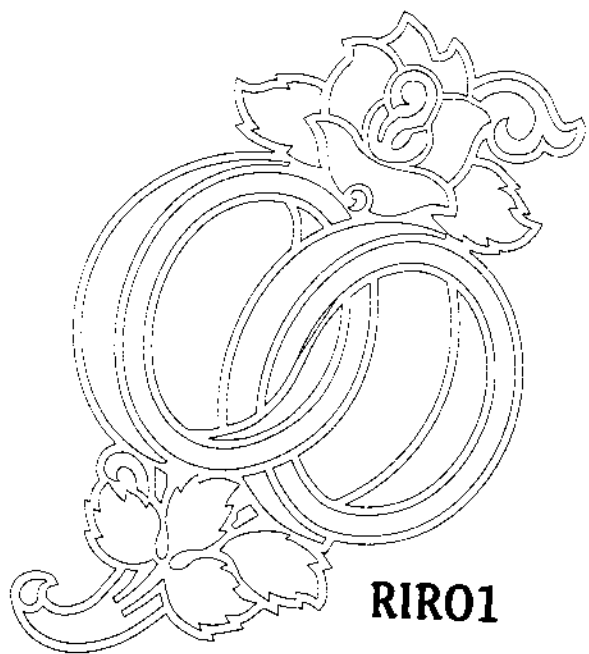

RIRO1

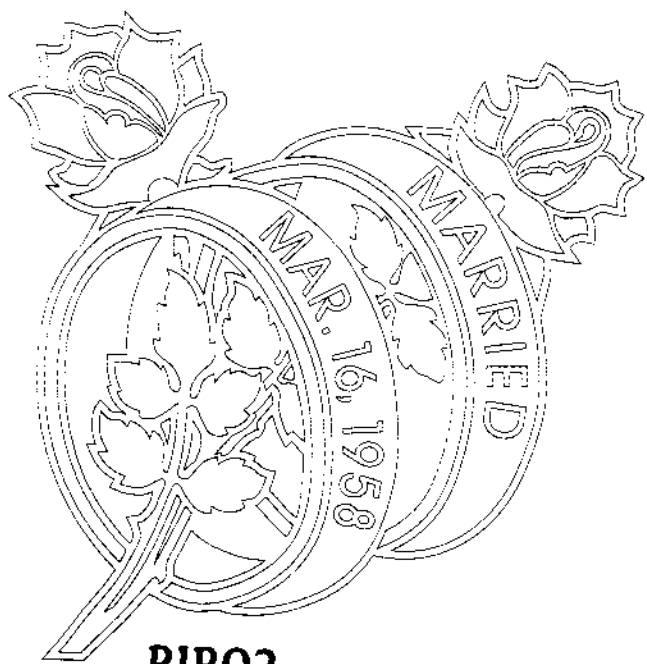

RIRO2

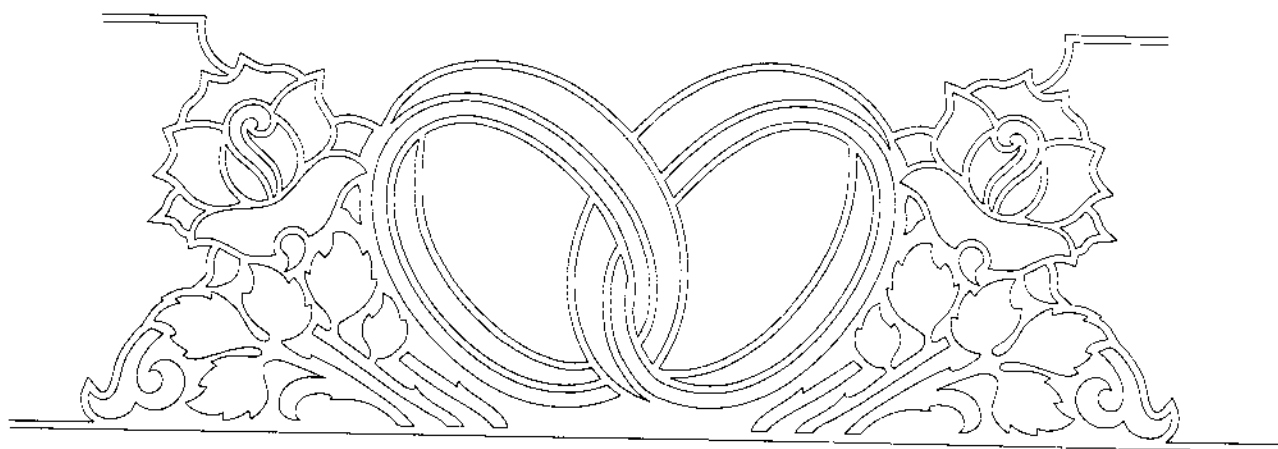

RIRO3

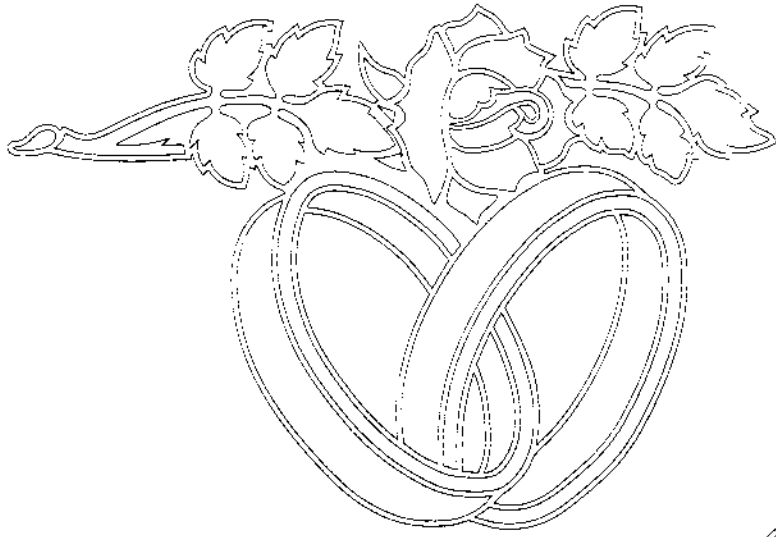

RIR04

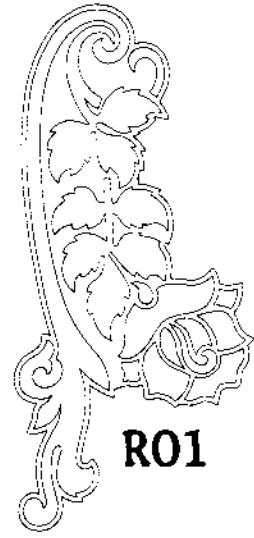

R01

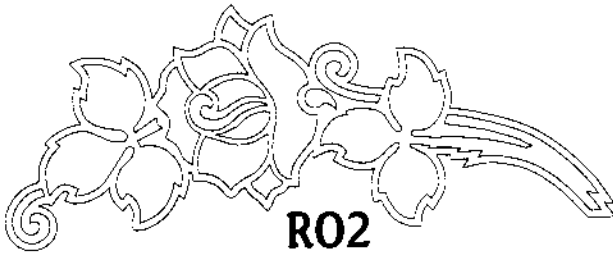

R02



R03

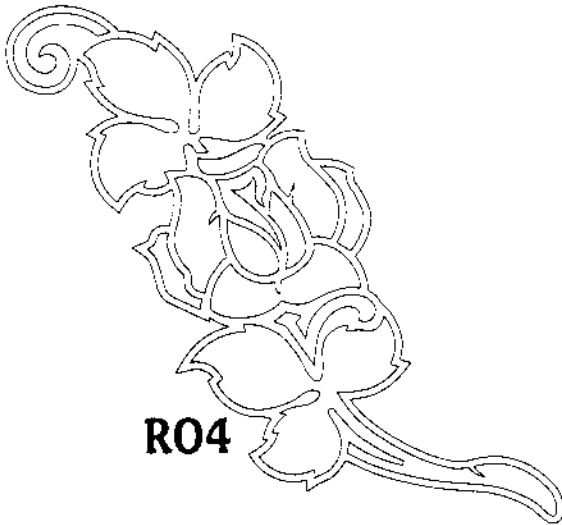

R04

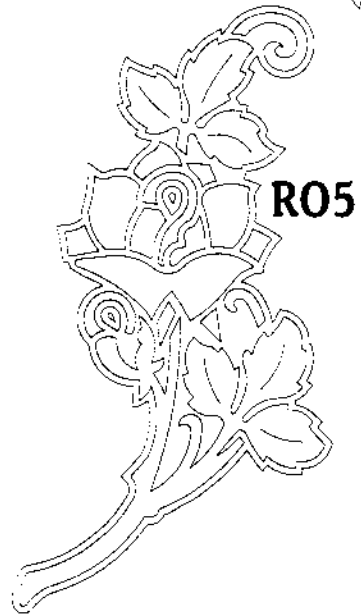

R05

#1

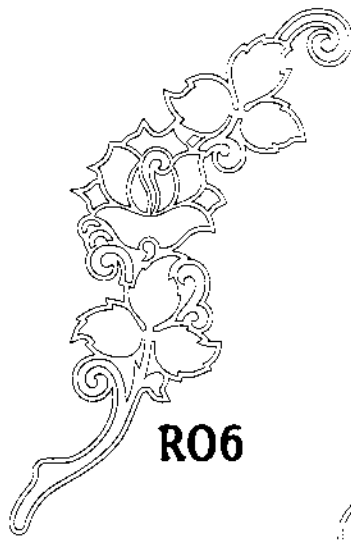

R06



R07

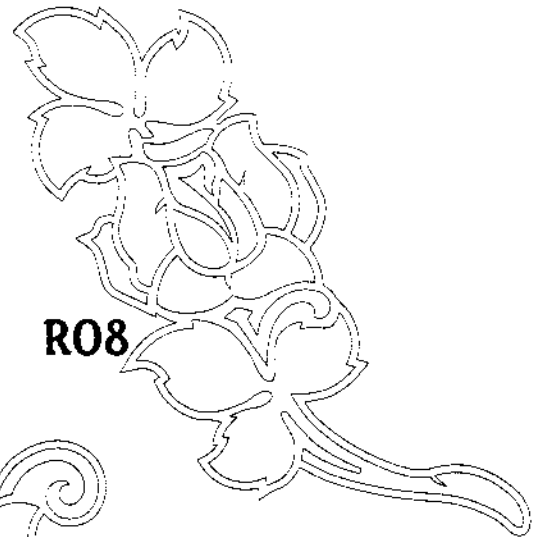

R08

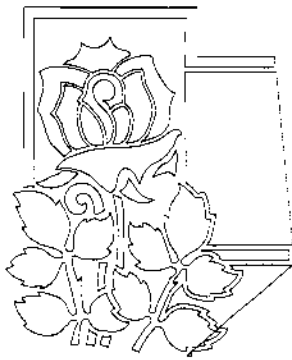

R09

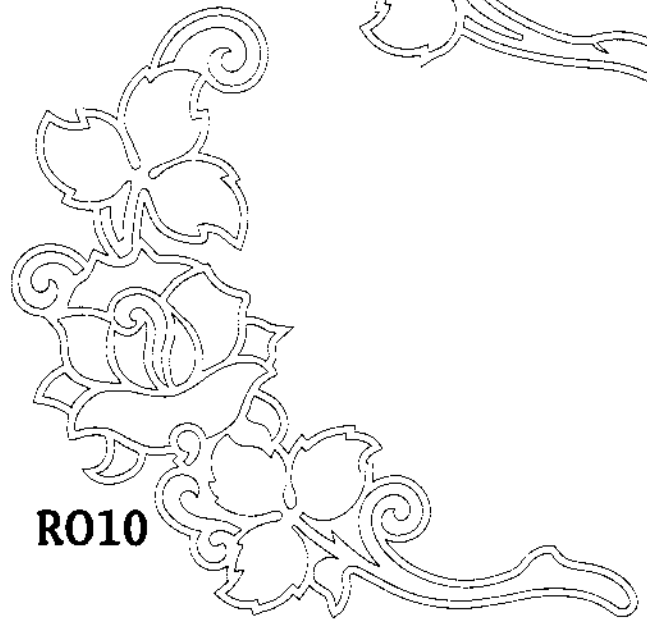

R010

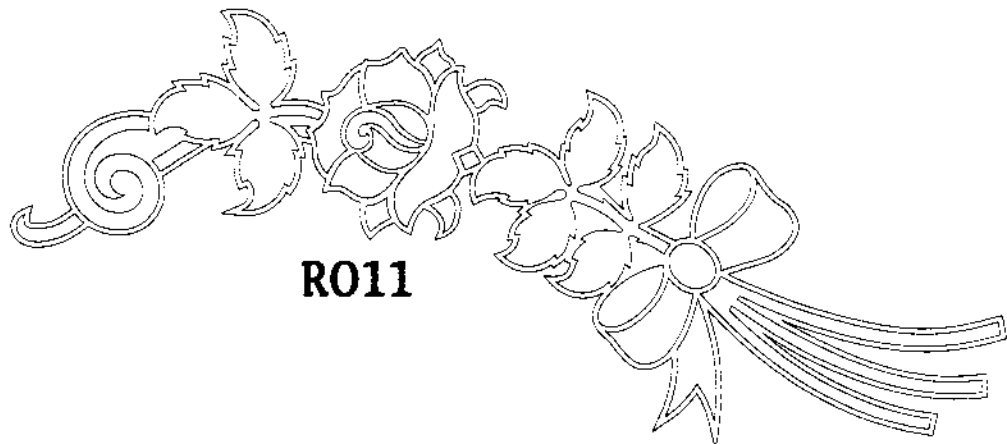

R011

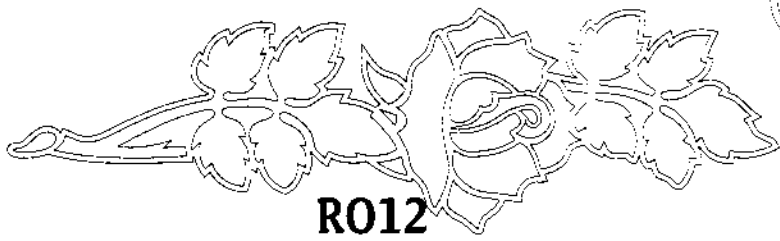

R012

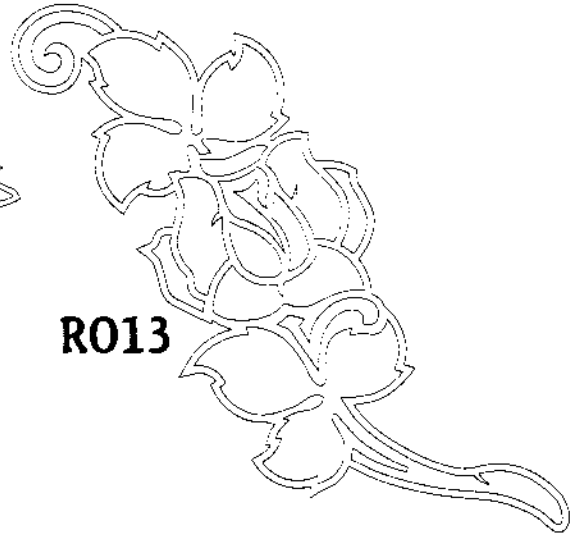

R013

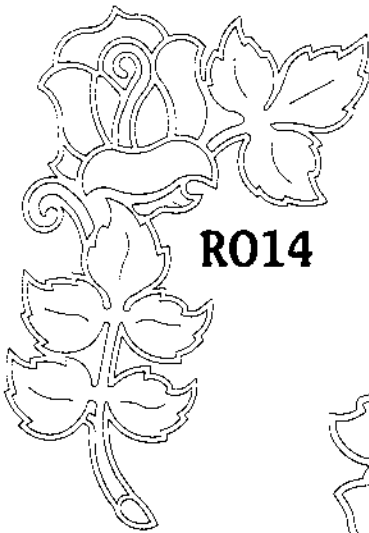

R014

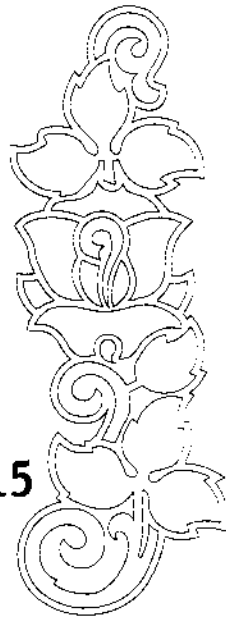

R015

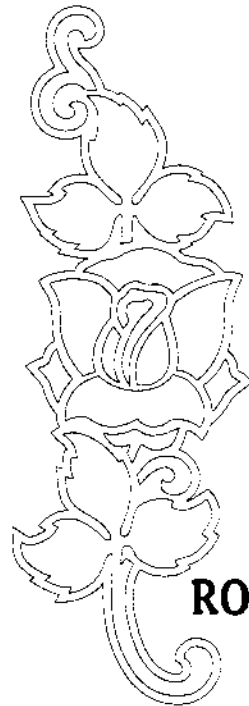

R016

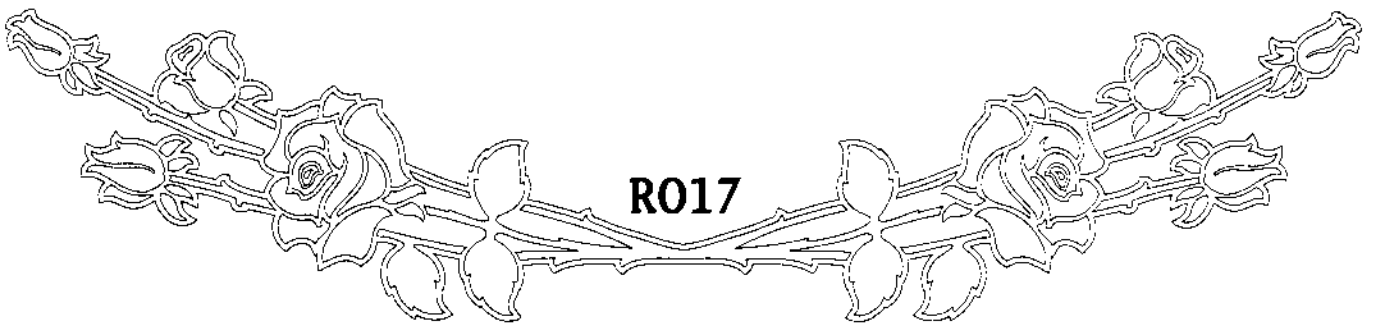

R017

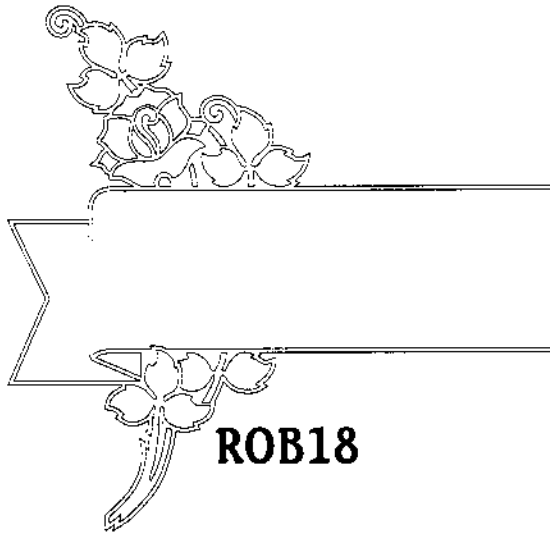

ROB18

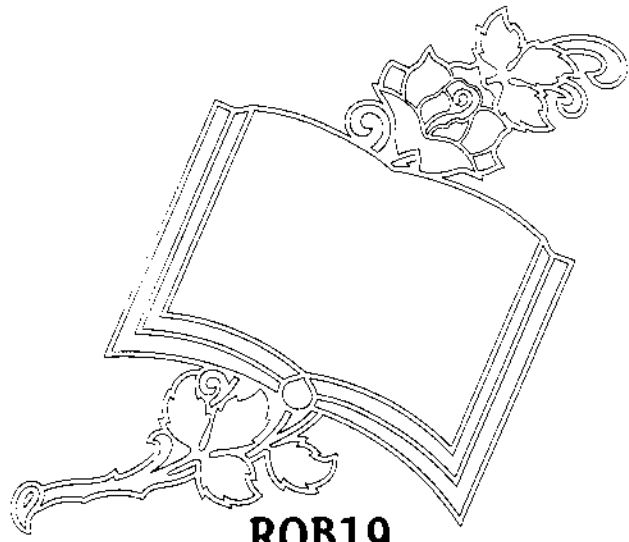

ROB19



ROB20

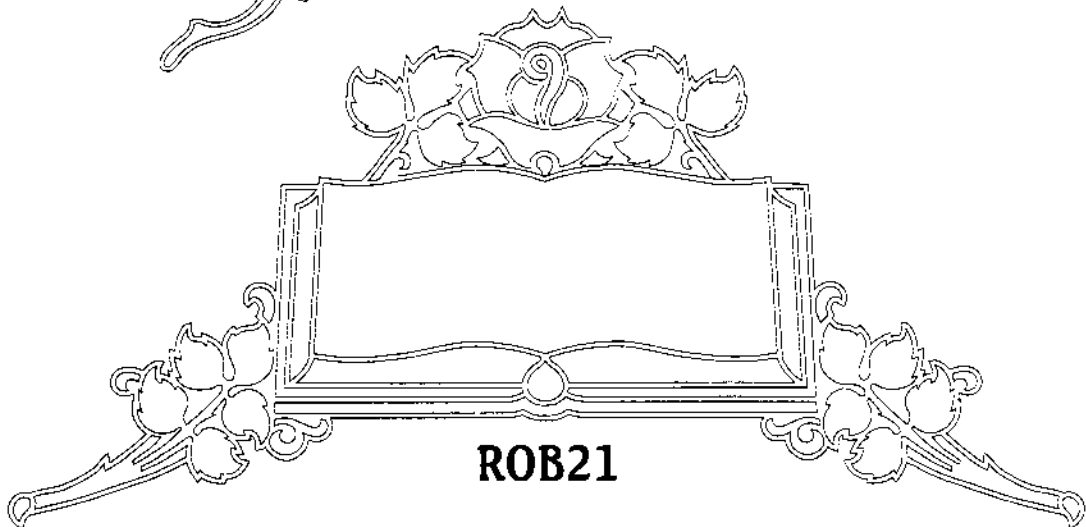

ROB21

#4

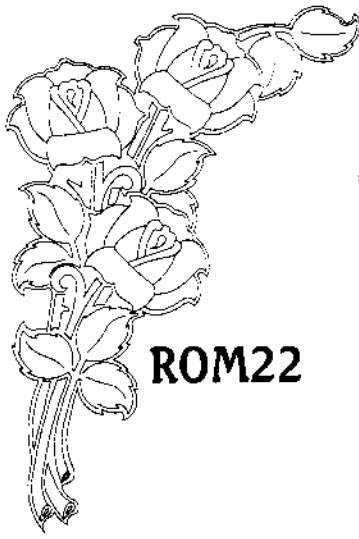

ROM22

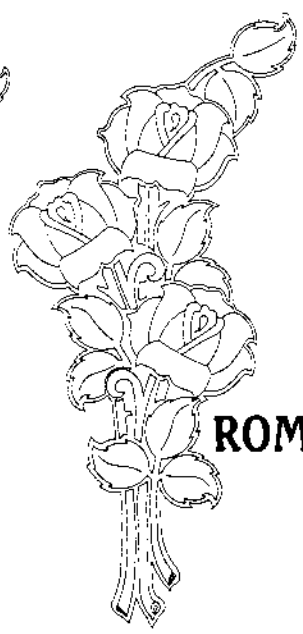

ROM23

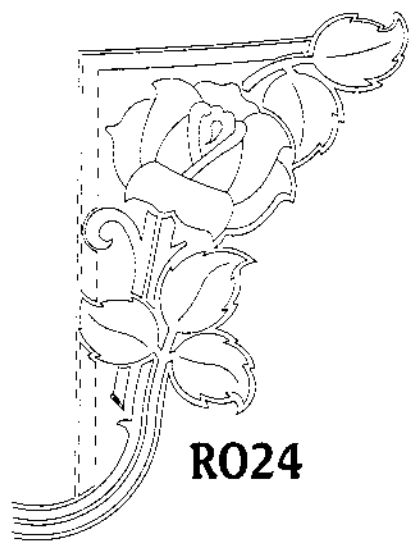

R024



R025

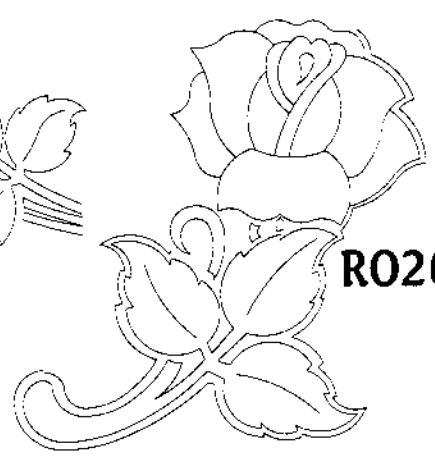

R026

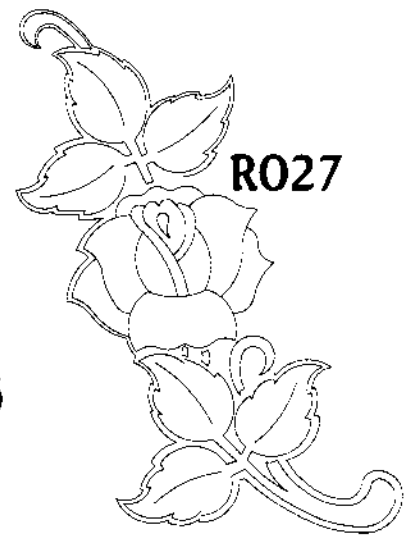

R027

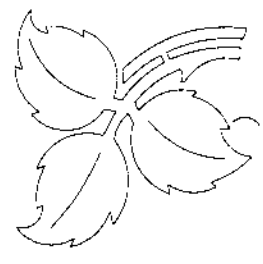

ROL29



ROL30

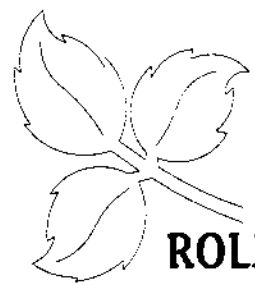

ROL31

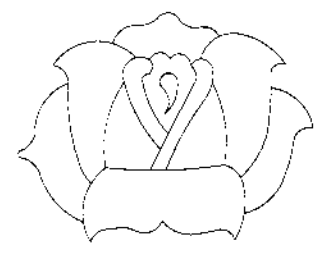

R032

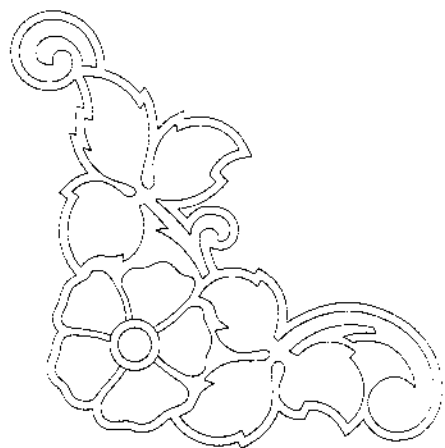

FLS1

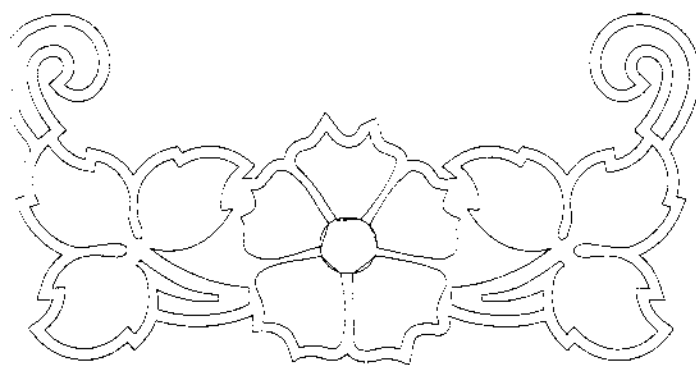

FLS2

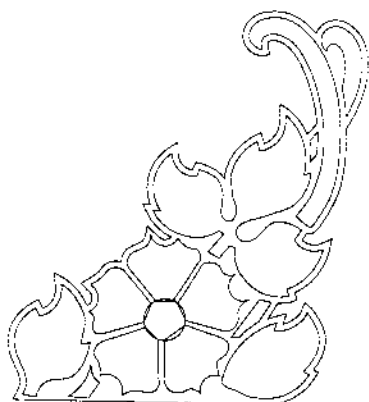

FLS3

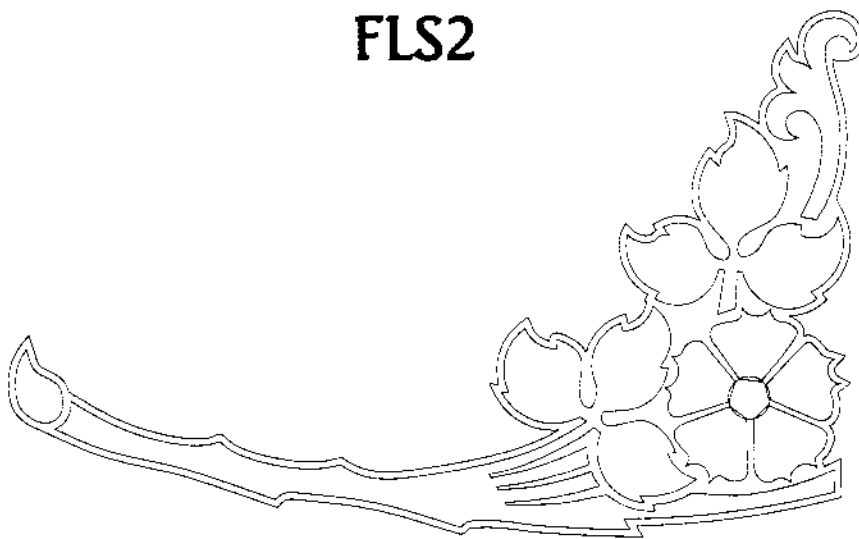

FLS4

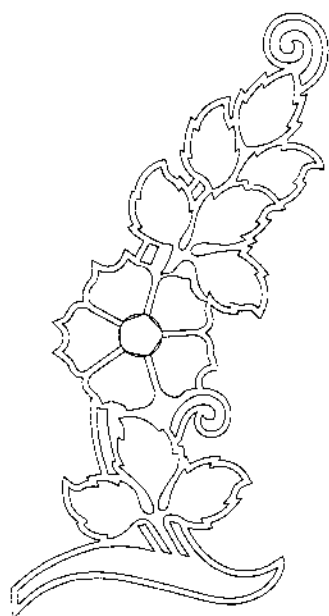

FLS5

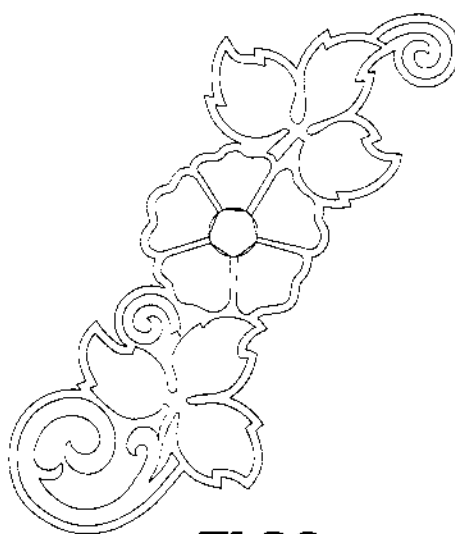

FLS6

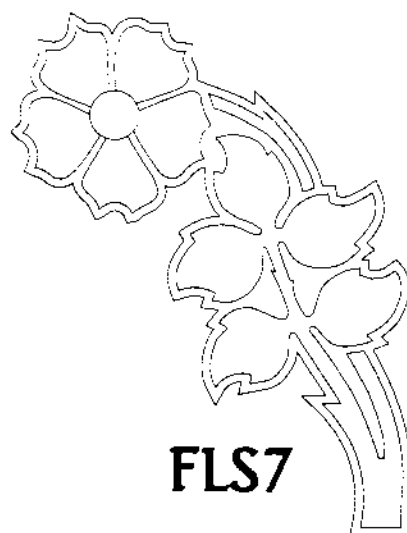

FLS7



FLS8

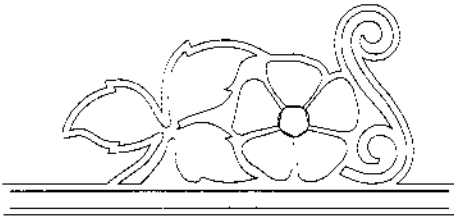

FLS9

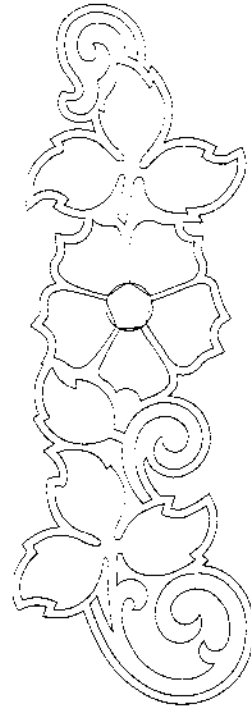
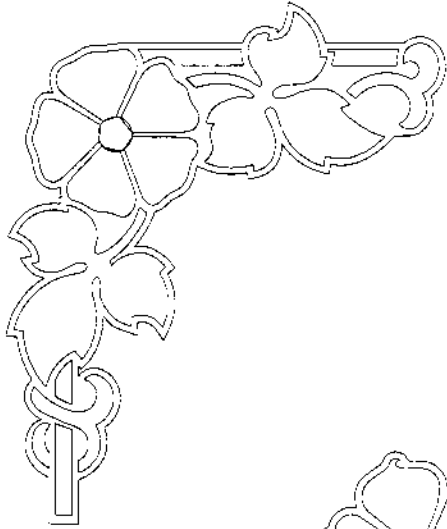

FLS10

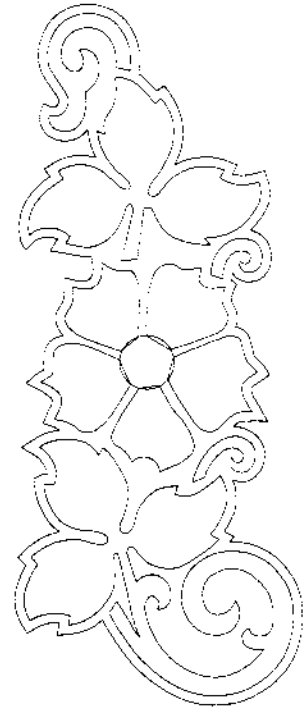

FLS11

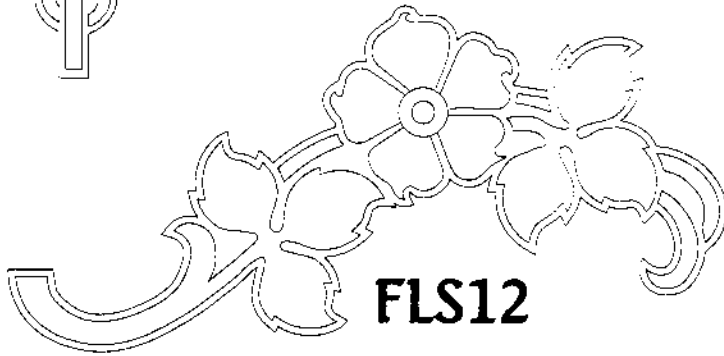

FLS12

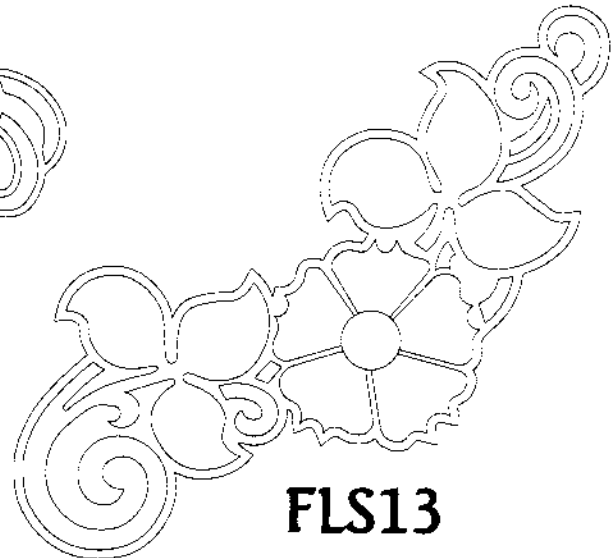

FLS13

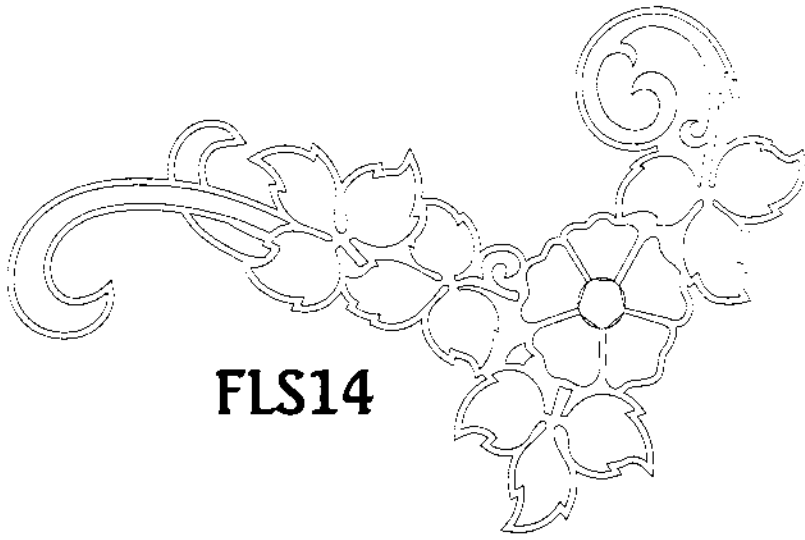

FLS14

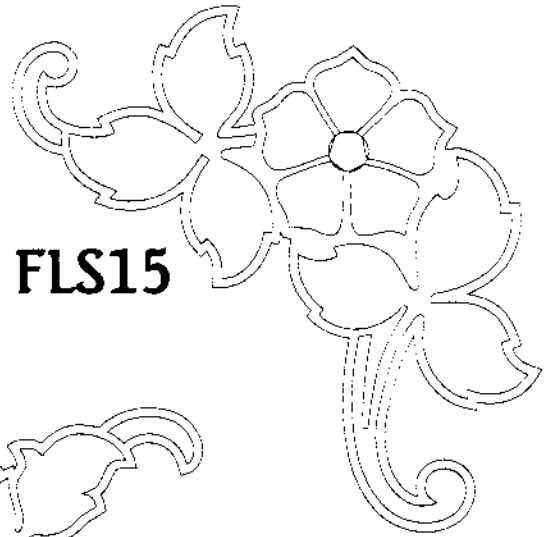

FLS15

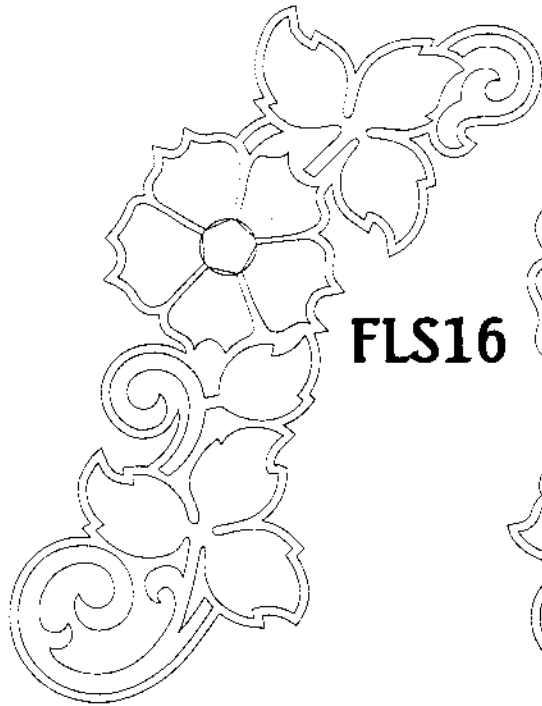

FLS16

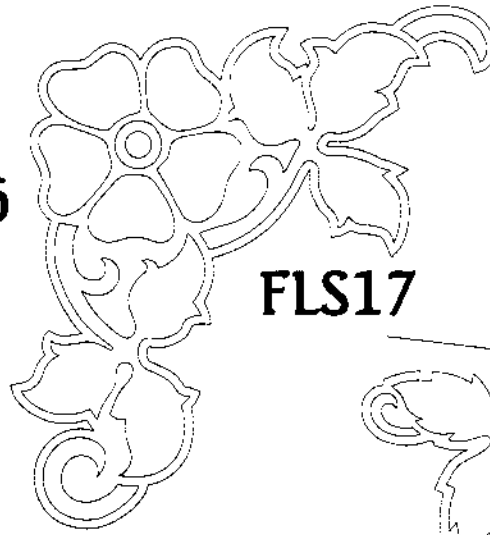

FLS17

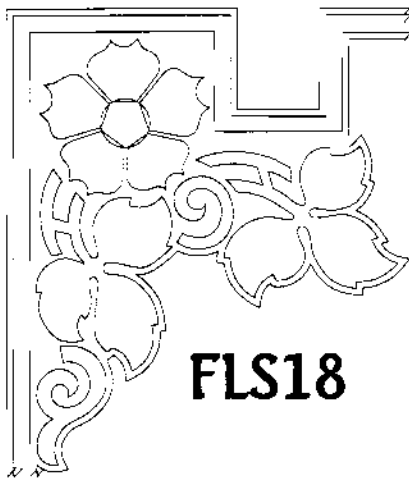

FLS18

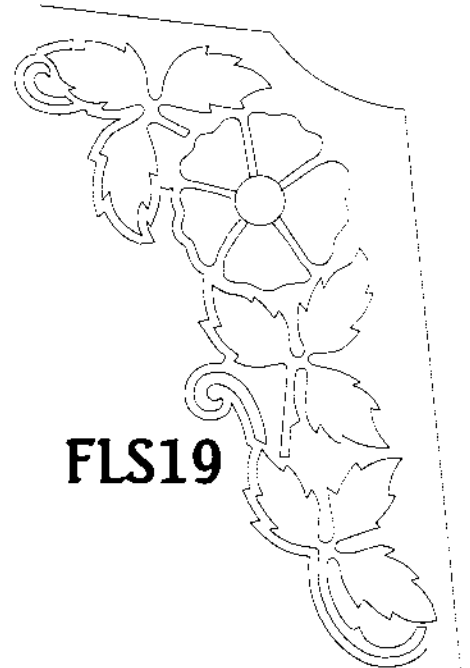

FLS19

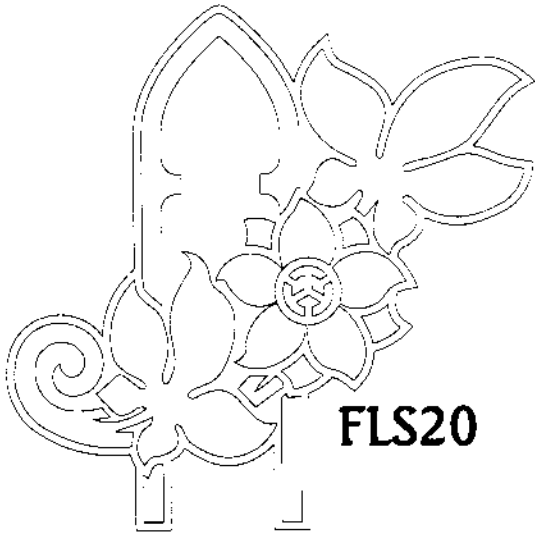

FLS20



FLS21

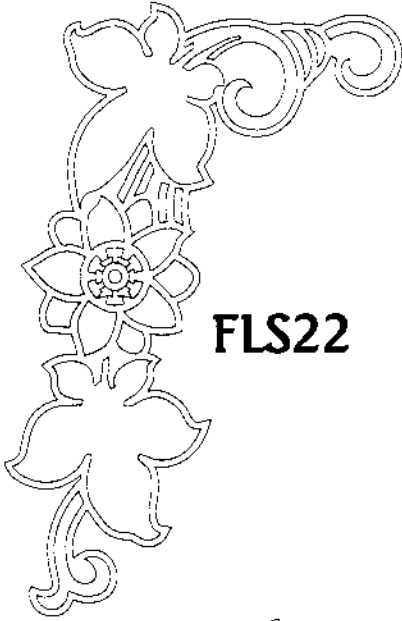

FLS22

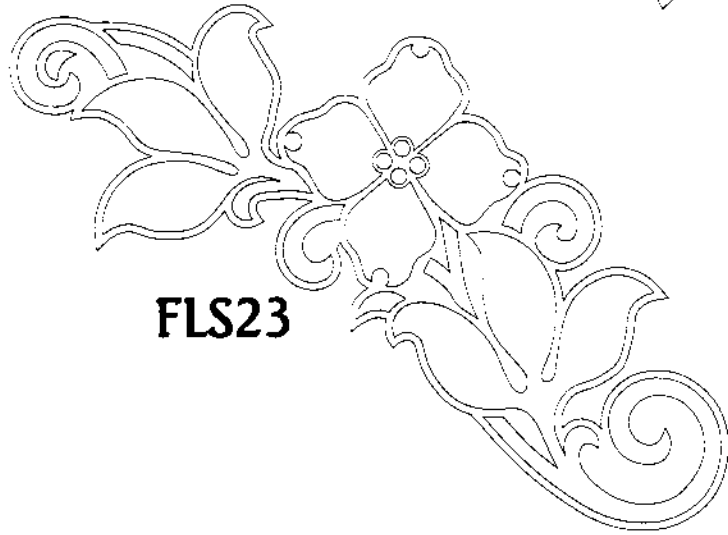

FLS23

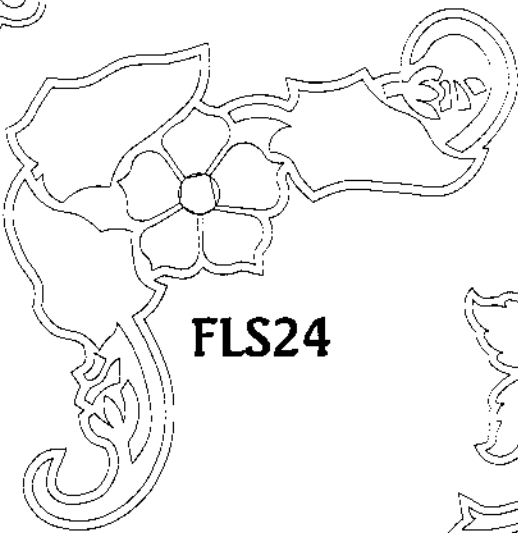

FLS24

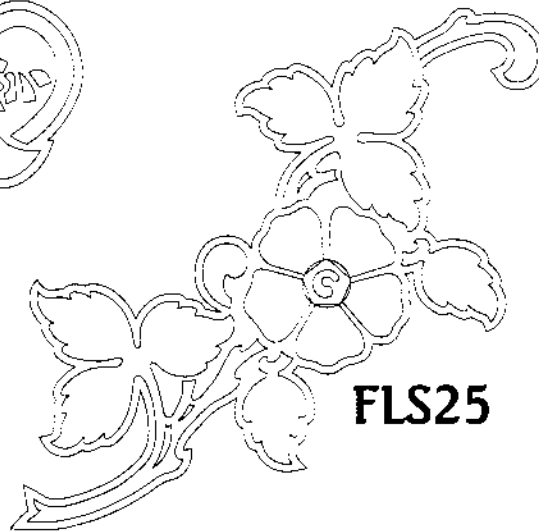

FLS25

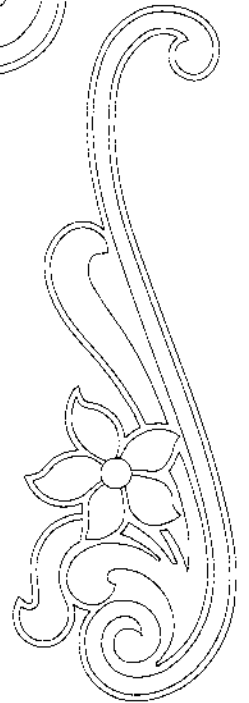

FLS26

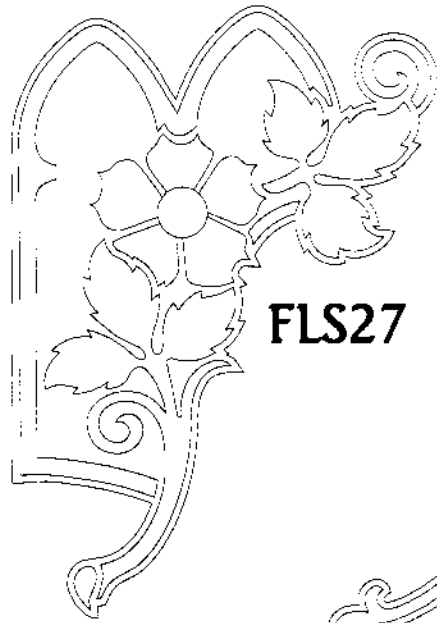

FLS27

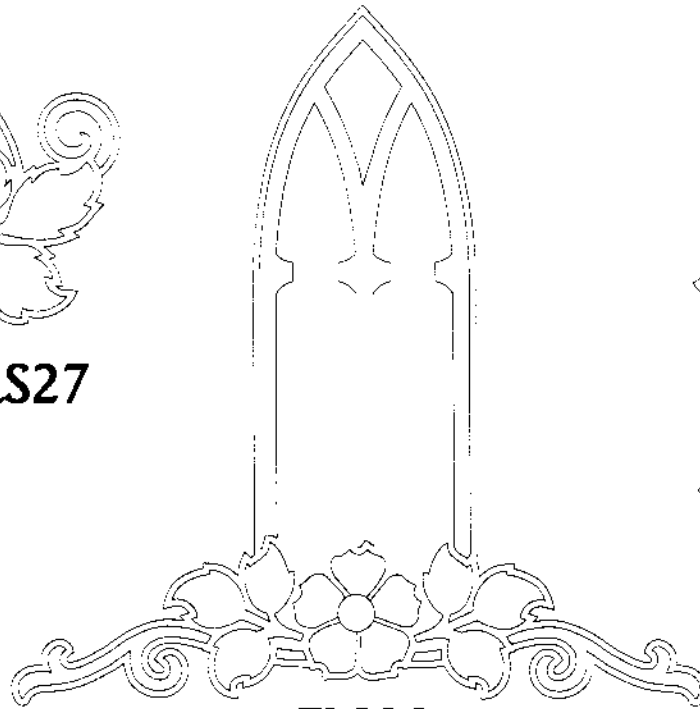

FLS28

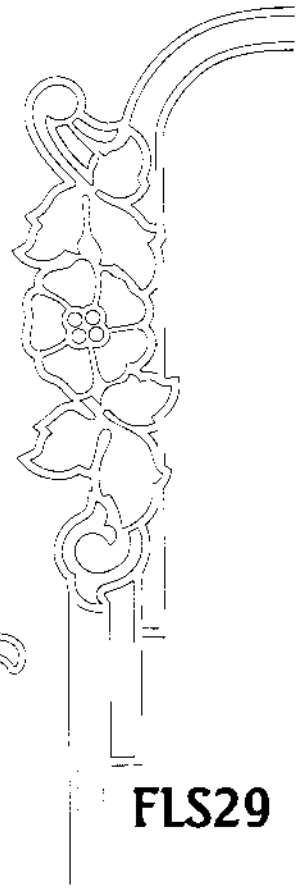

FLS29

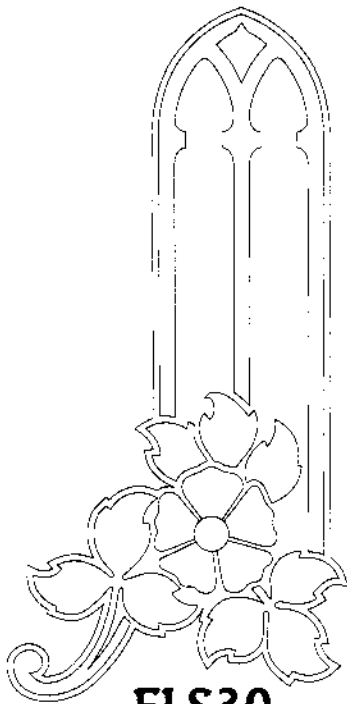

FLS30

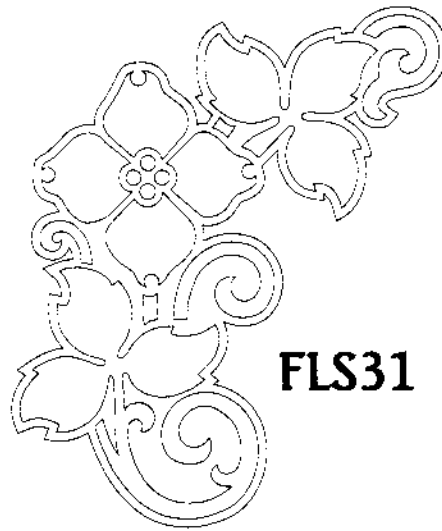

FLS31

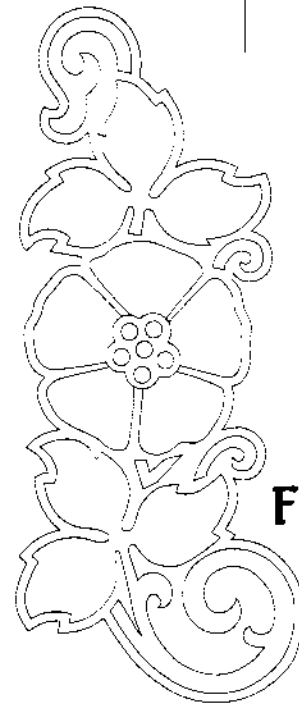

FLS32

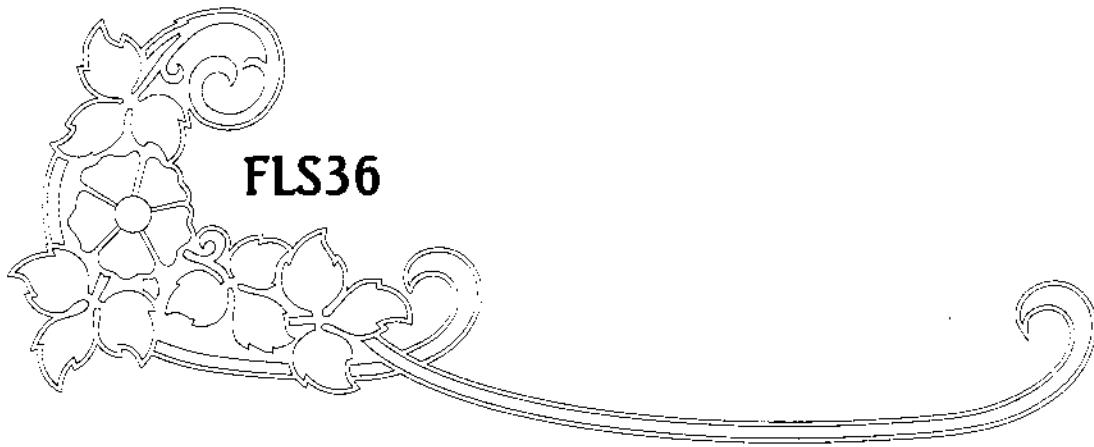

FLS36

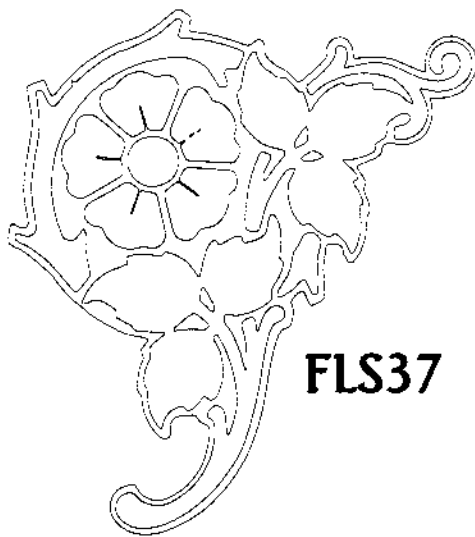

FLS37

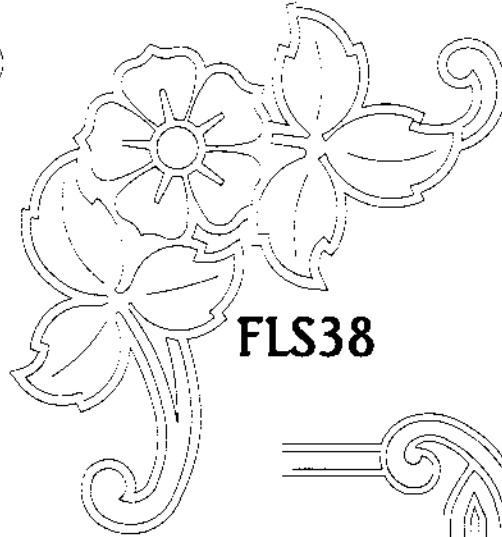

FLS38



FLS39

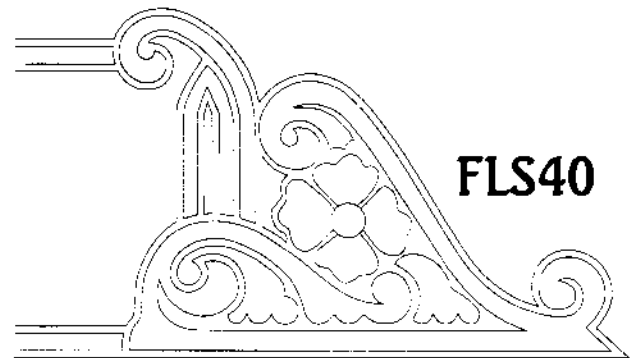

FLS40

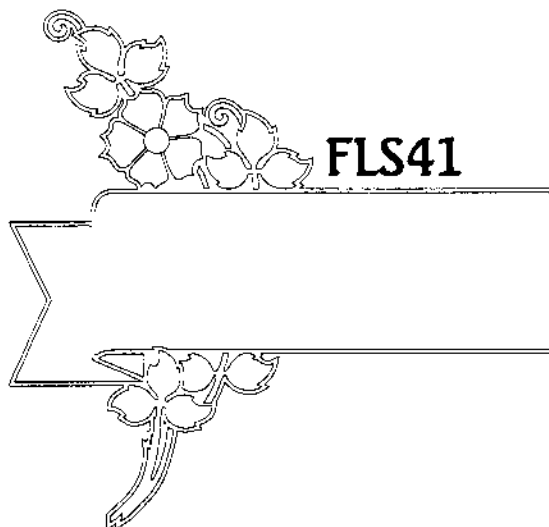

FLS41

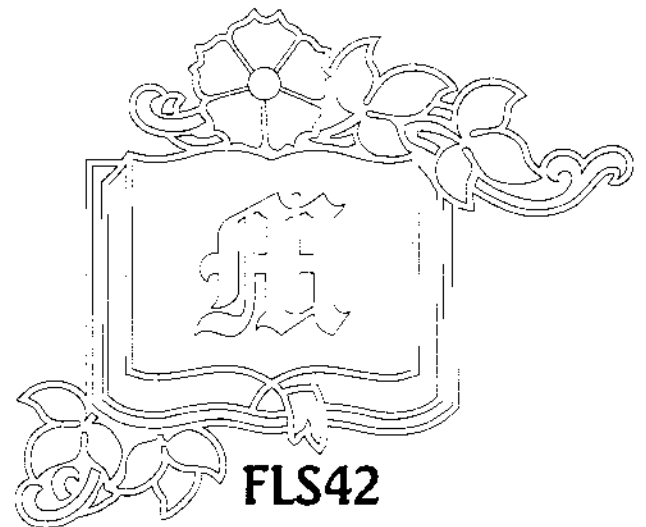

FLS42

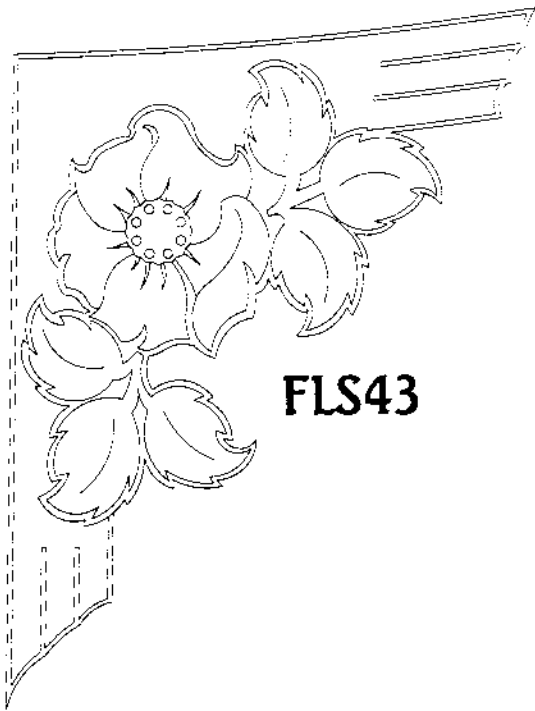

FLS43

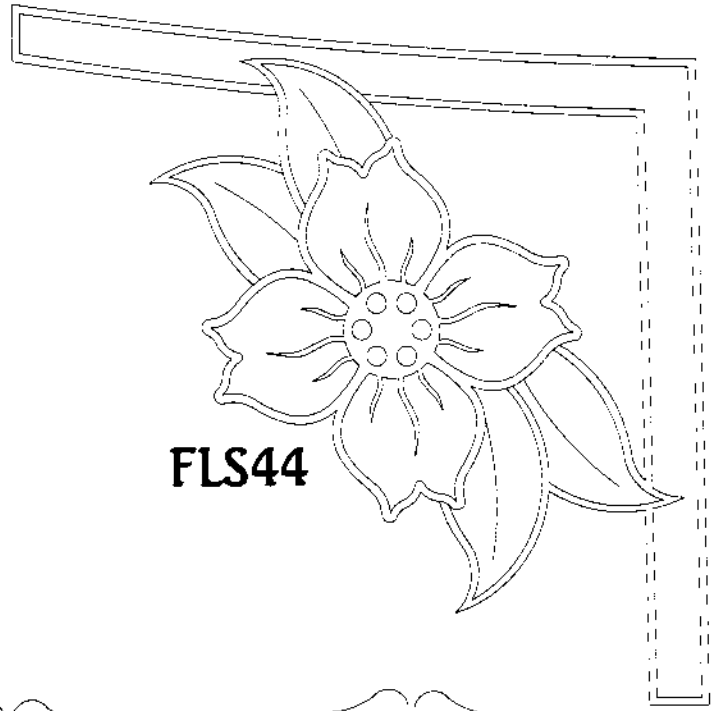

FLS44

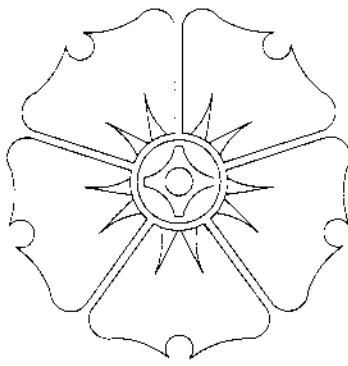

FLS45

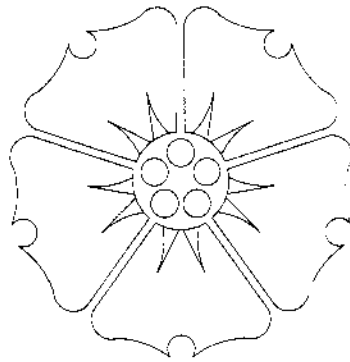

FLS46

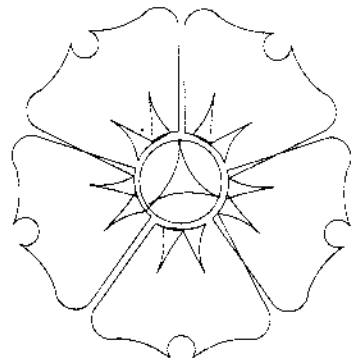

FLS47

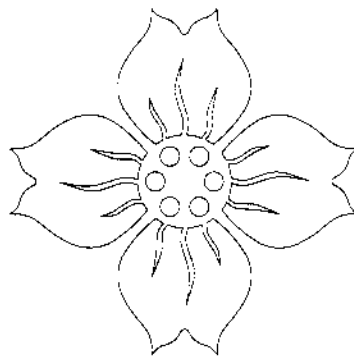

FLS48

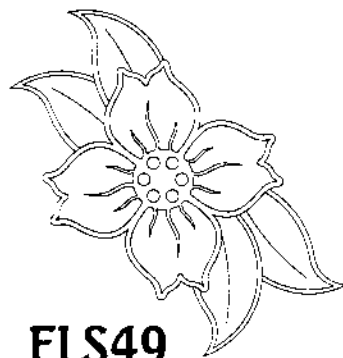

FLS49

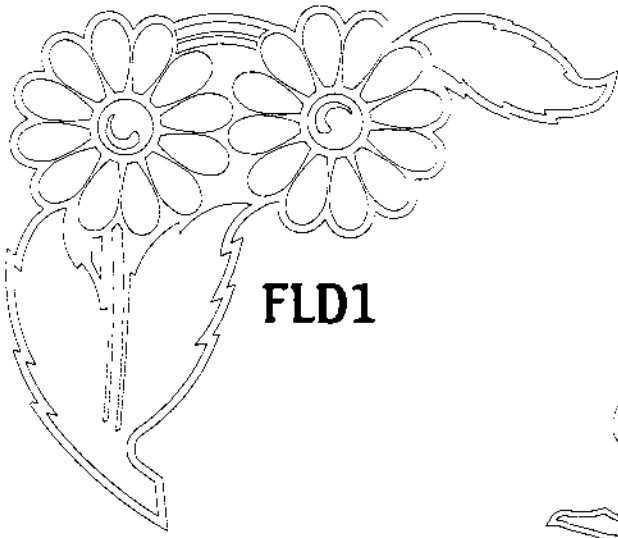

FLD1



FLD2

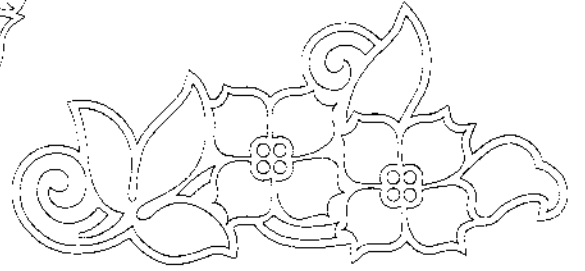

FLD3

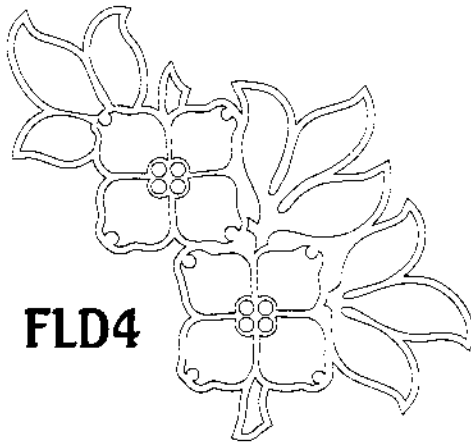

FLD4

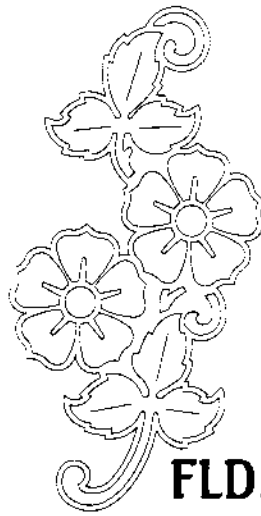

FLD5

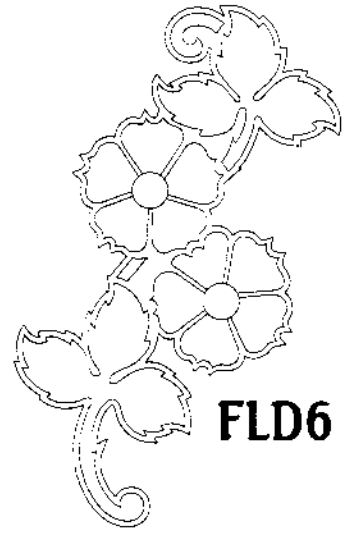

FLD6

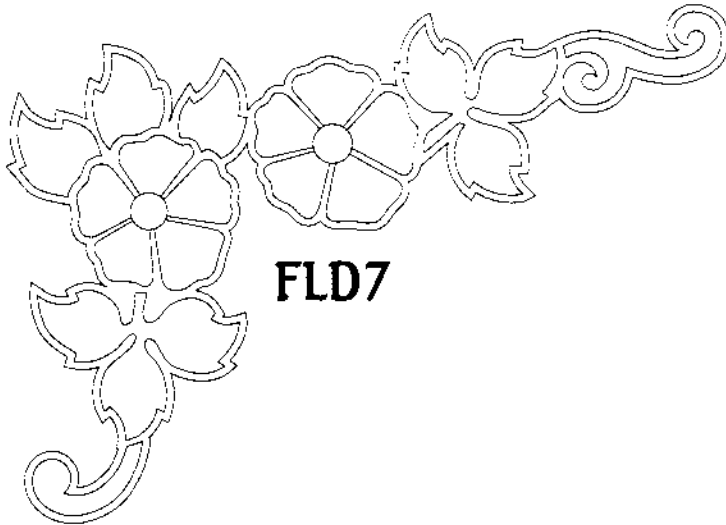

FLD7

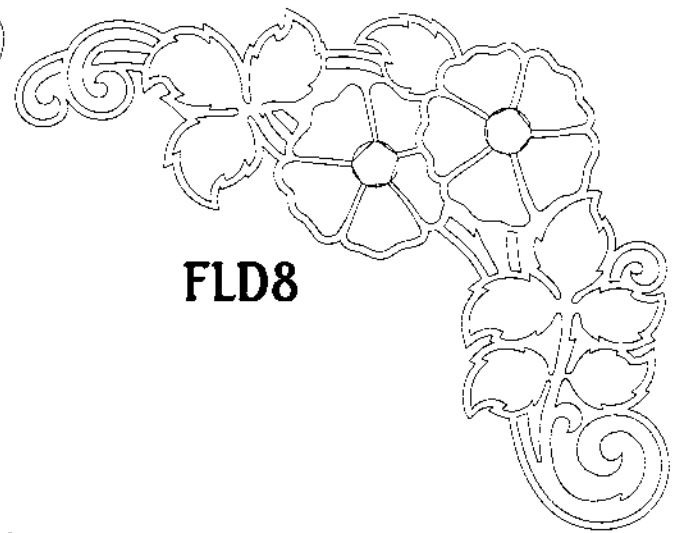

FLD8

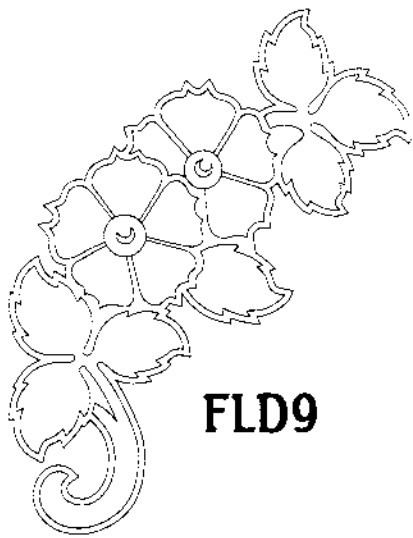

FLD9

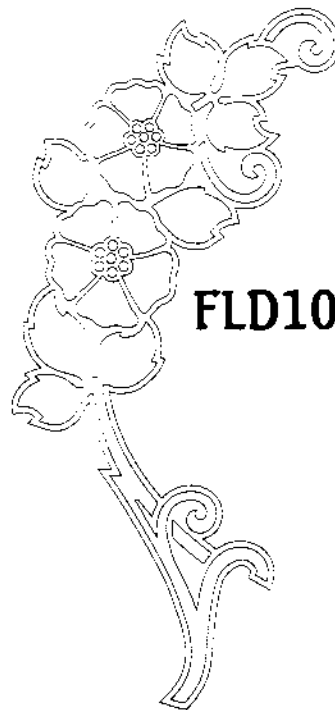

FLD10

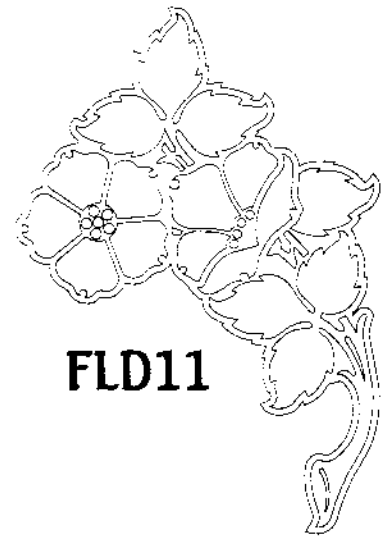

FLD11

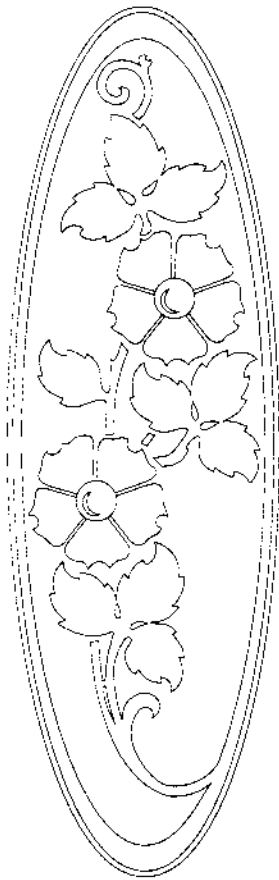

FLD12

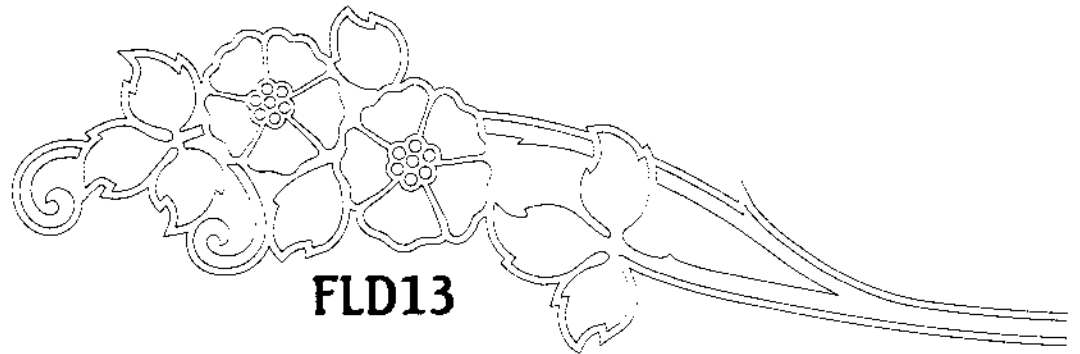

FLD13

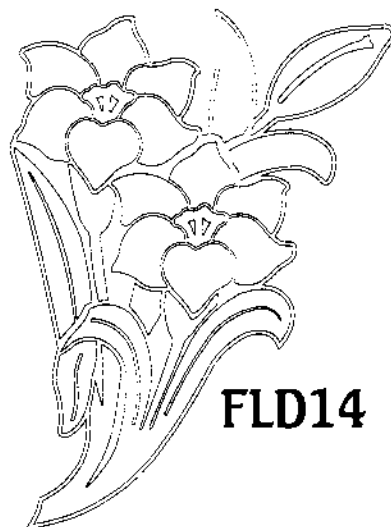

FLD14

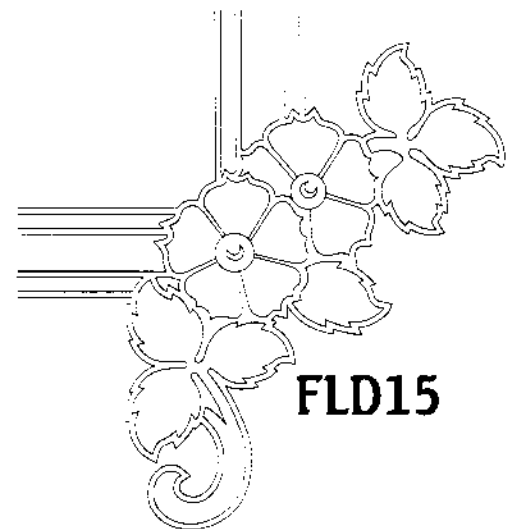

FLD15

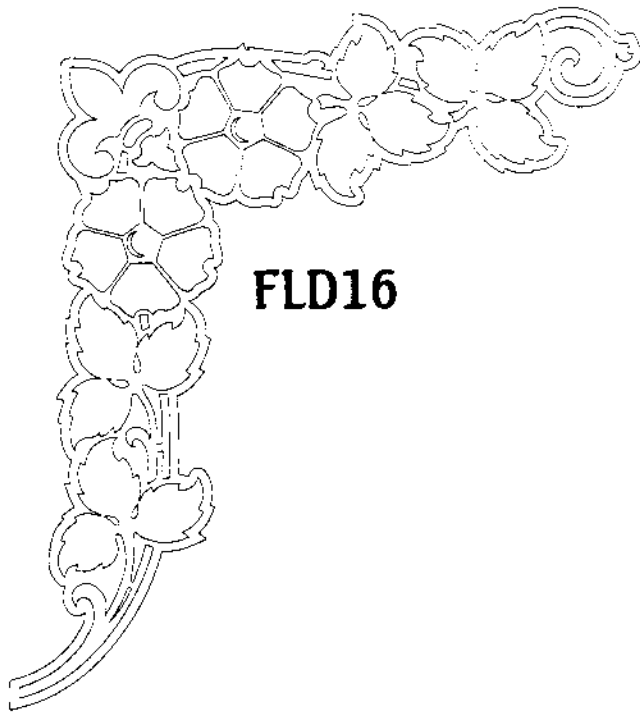

FLD16

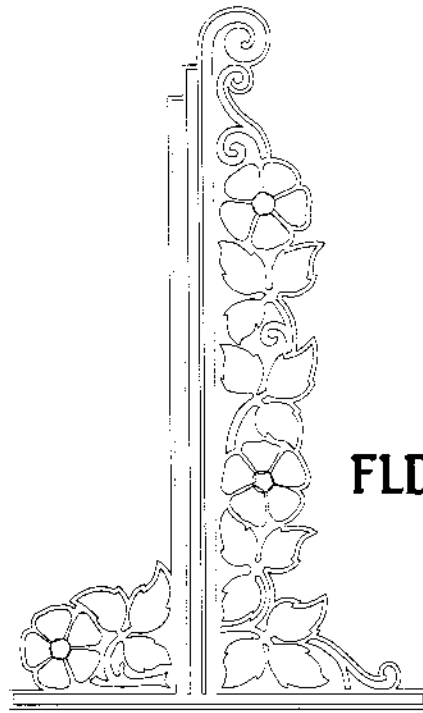

FLD17

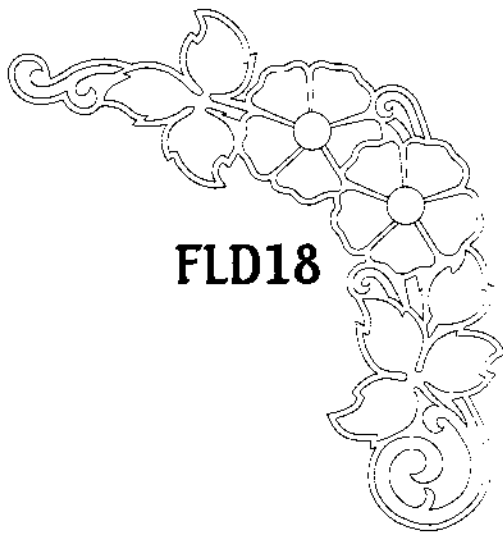

FLD18

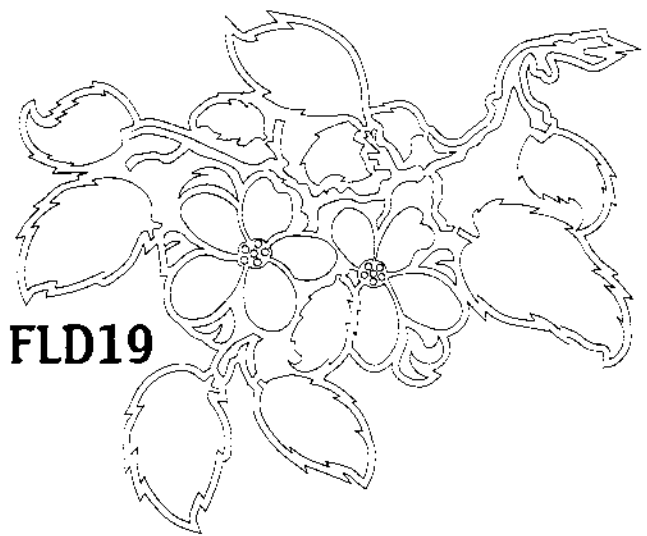

FLD19

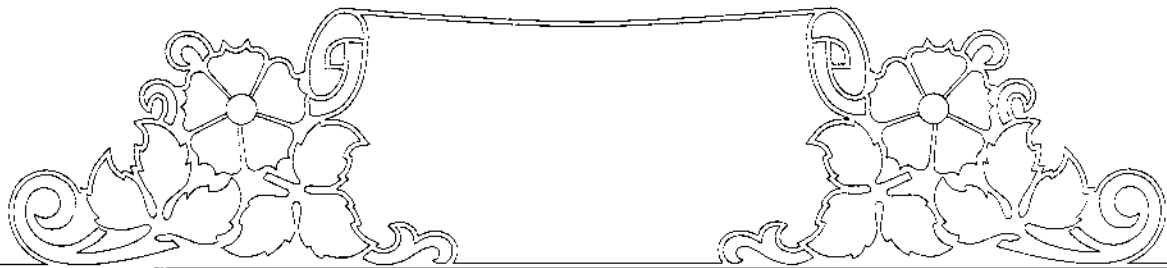

FLD20

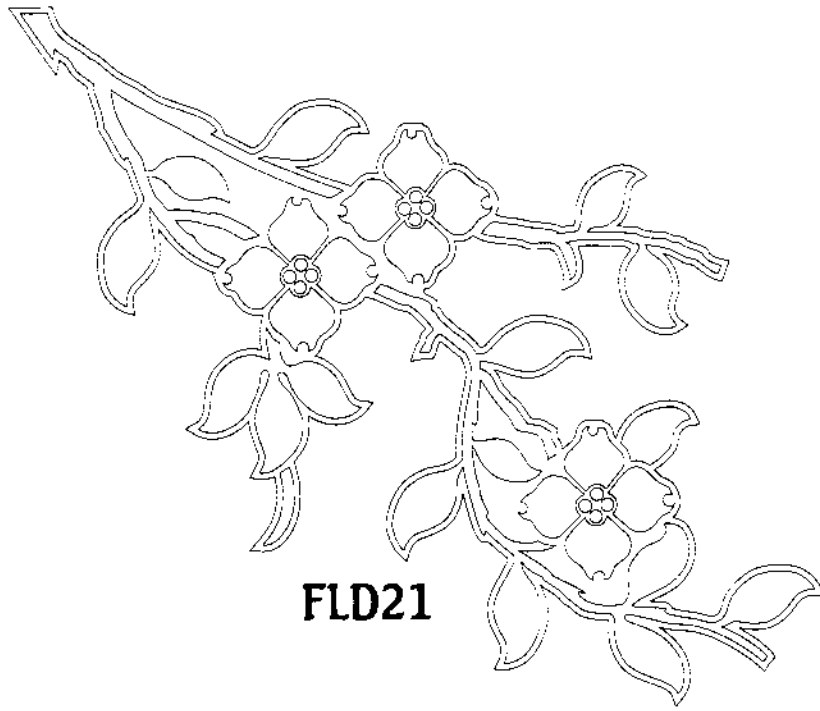

FLD21

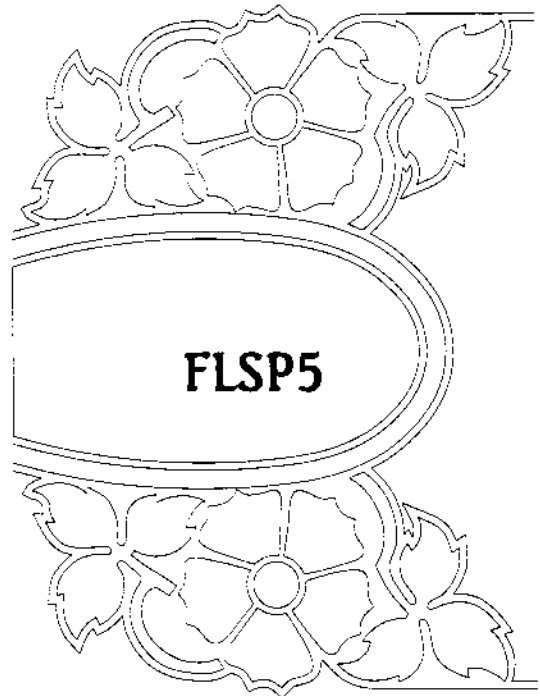
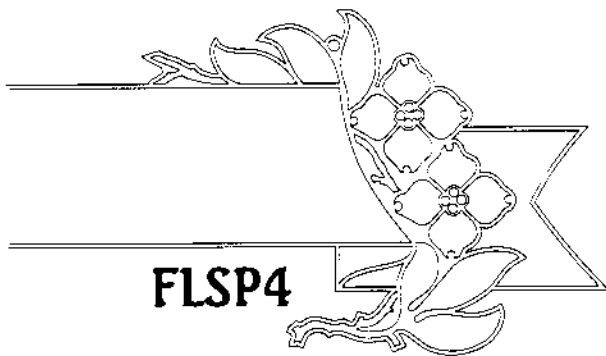
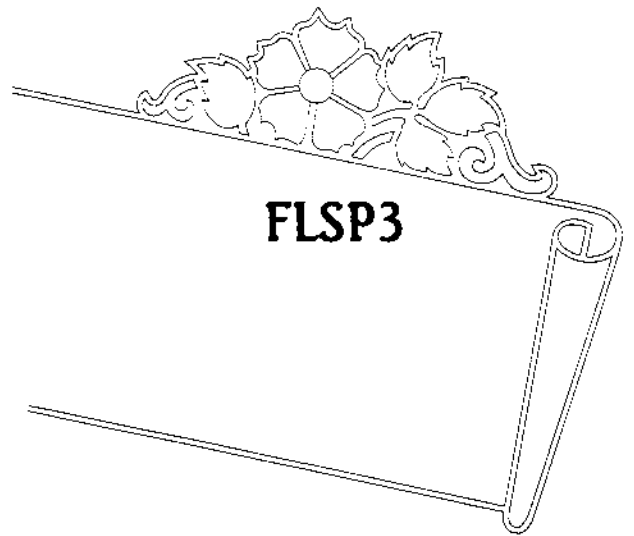
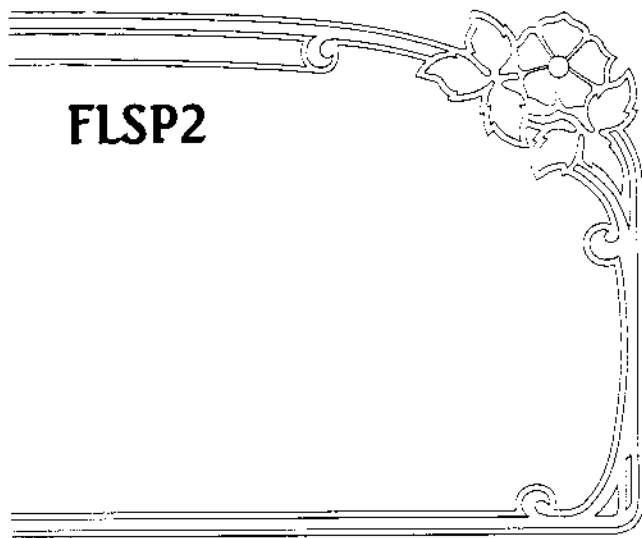
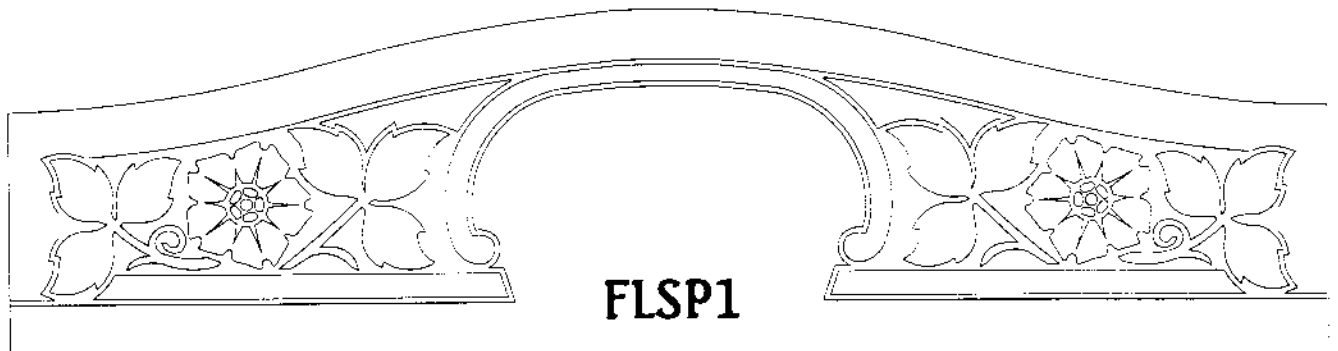

#1

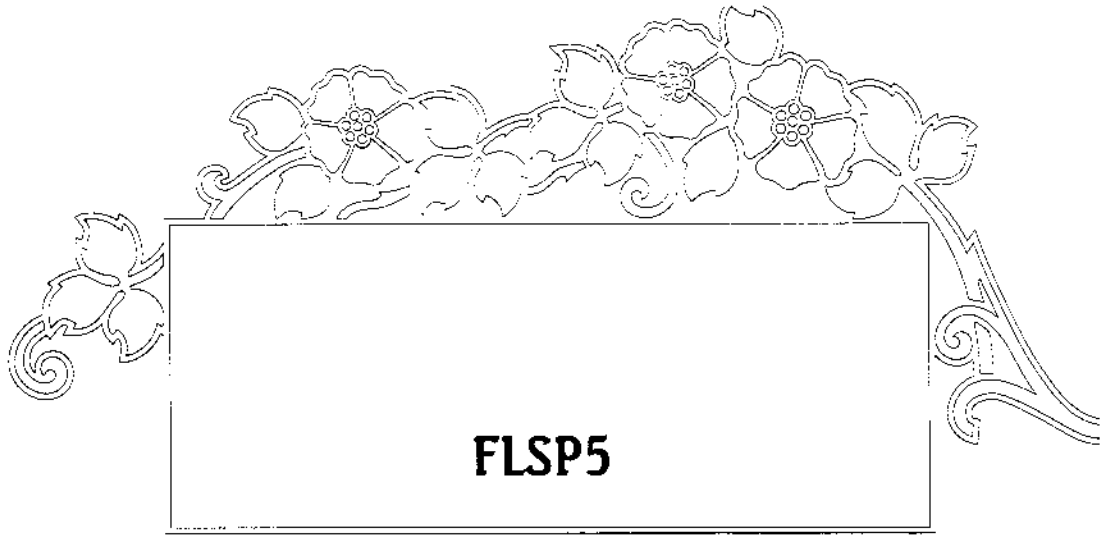

FLSP5

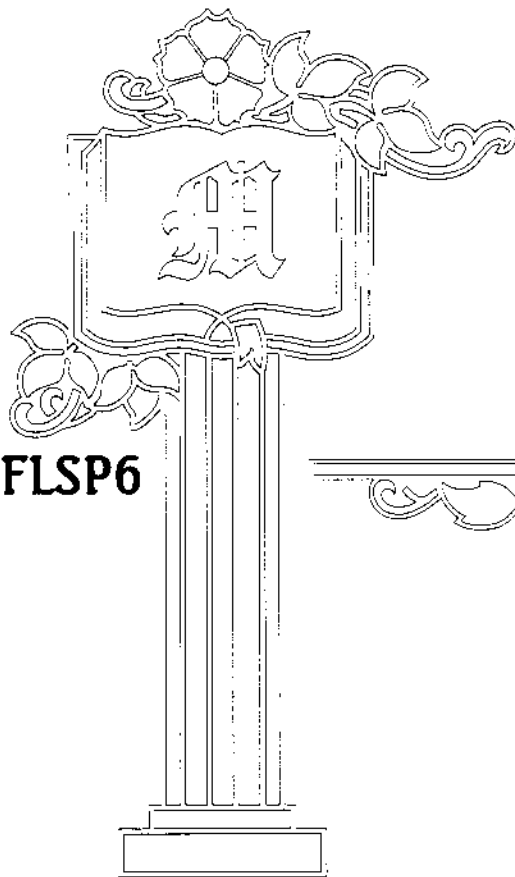

FLSP6

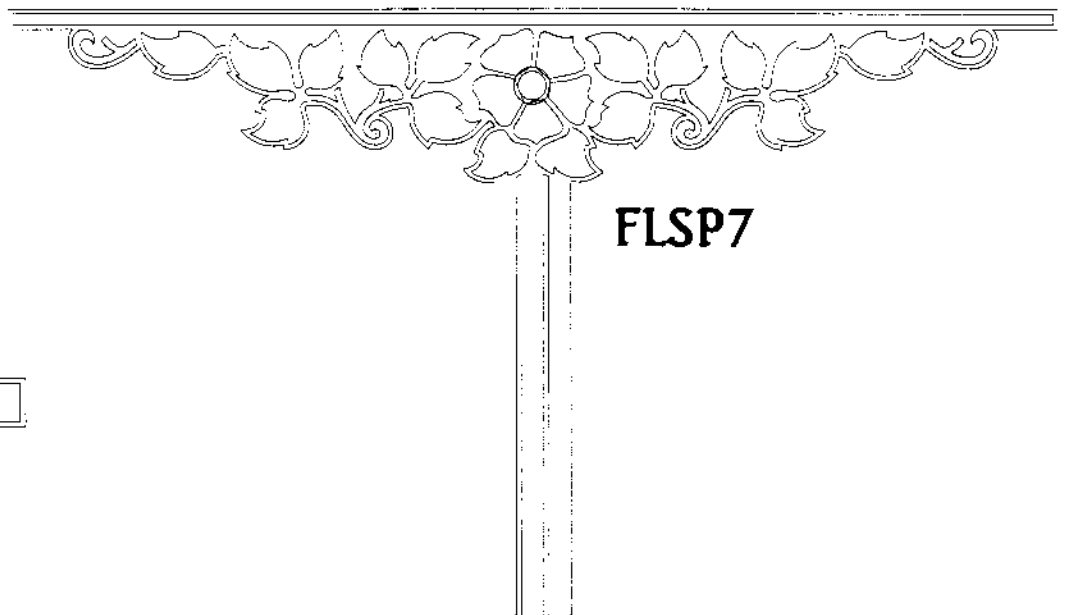

FLSP7

#2

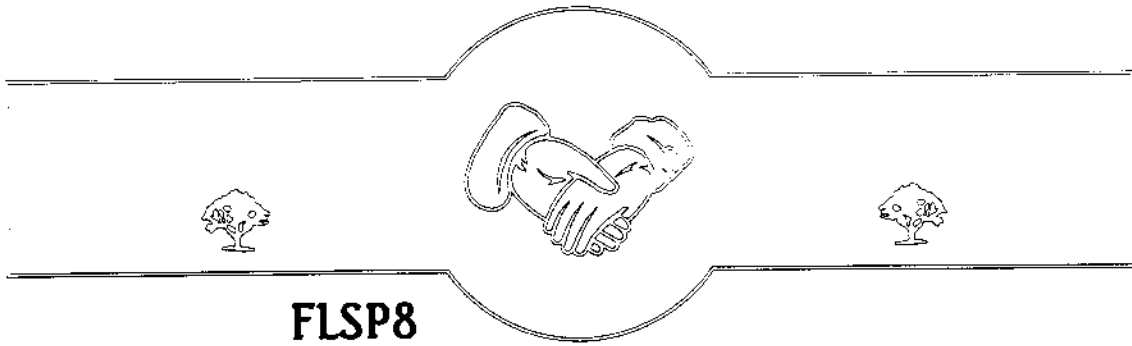
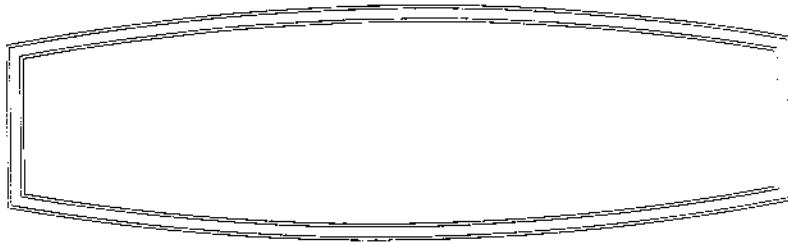

FLSP8

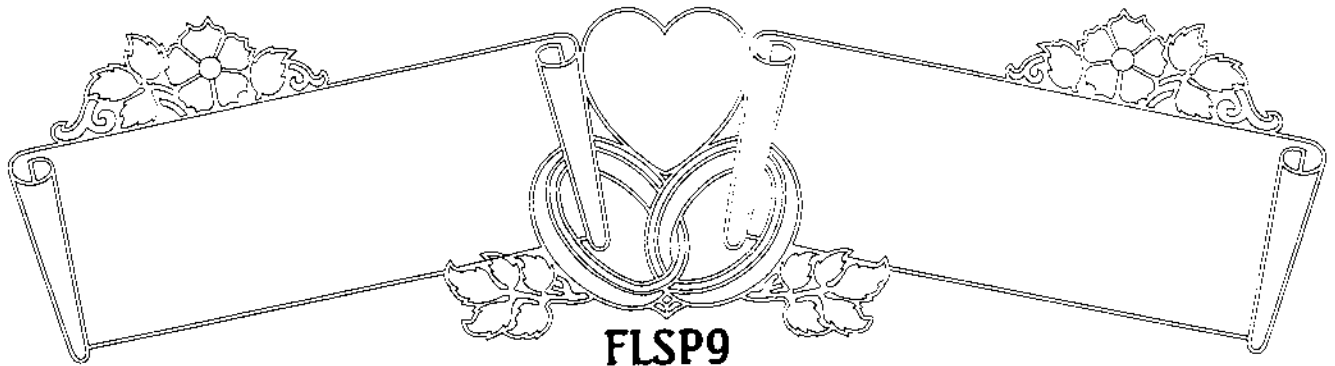

FLSP9

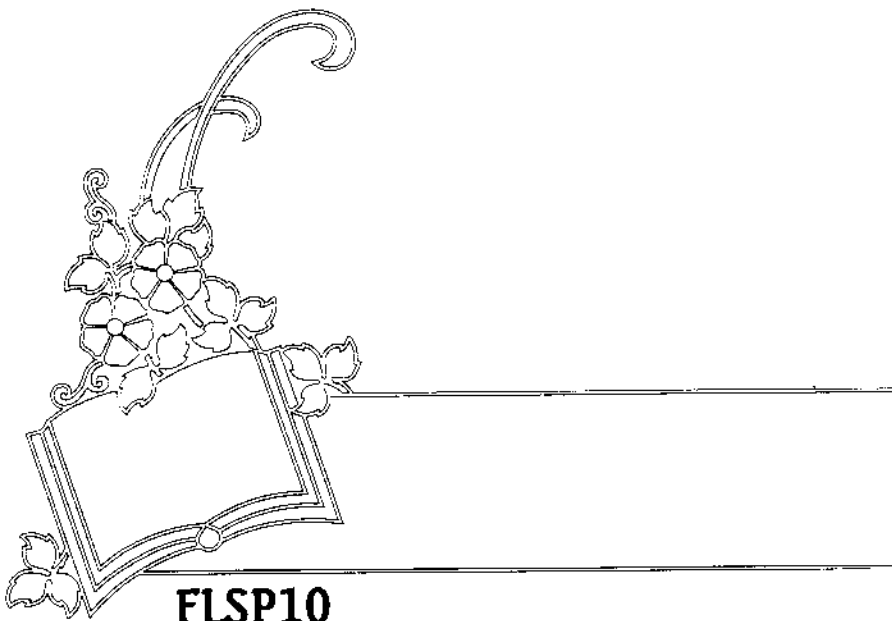

FLSP10

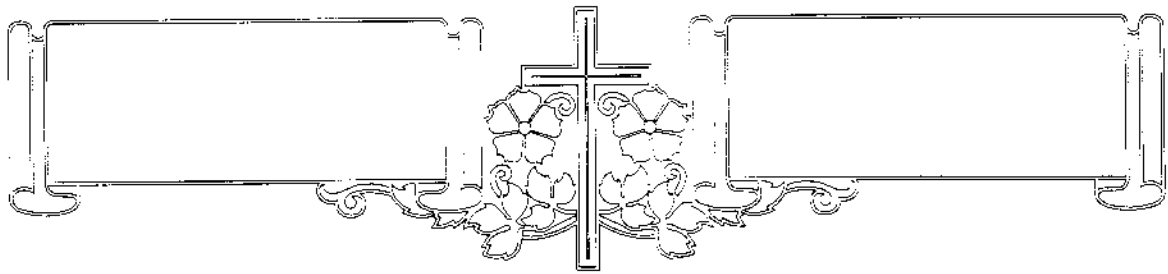

FLSP11

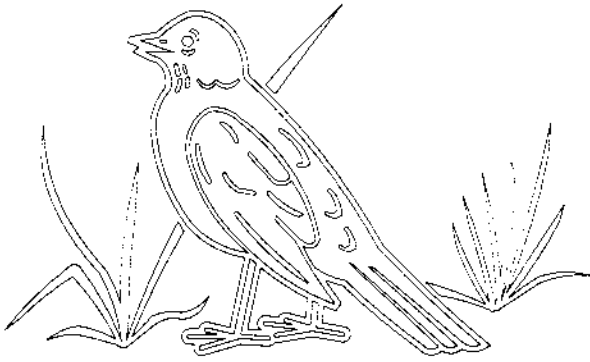

B1



B2

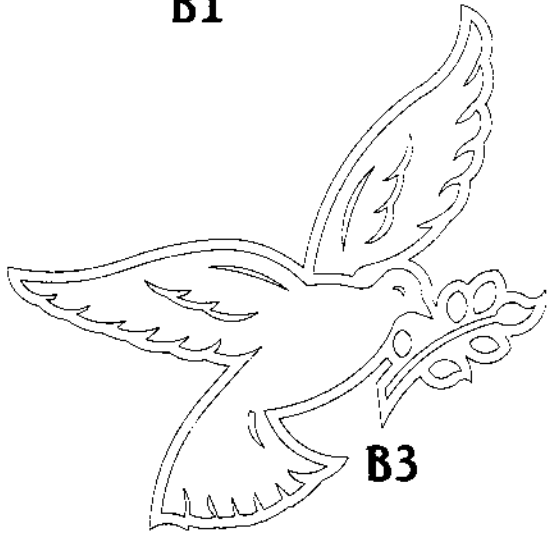

B3

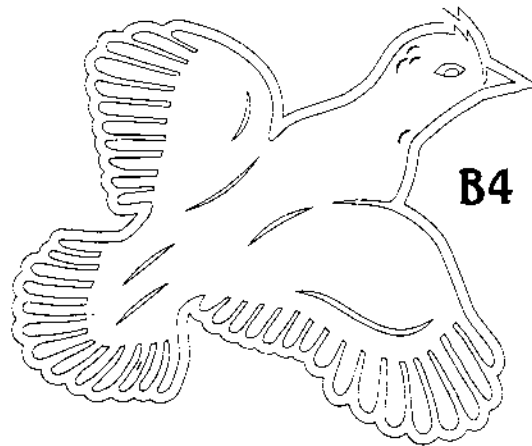

B4

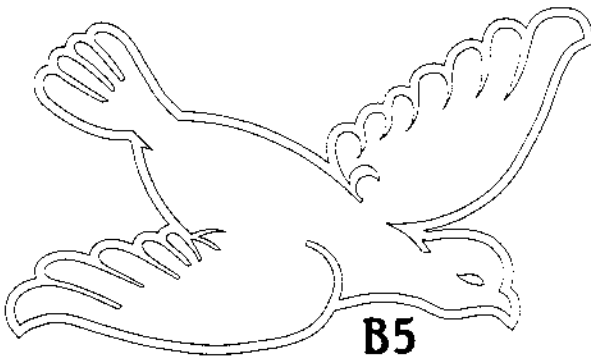

B5

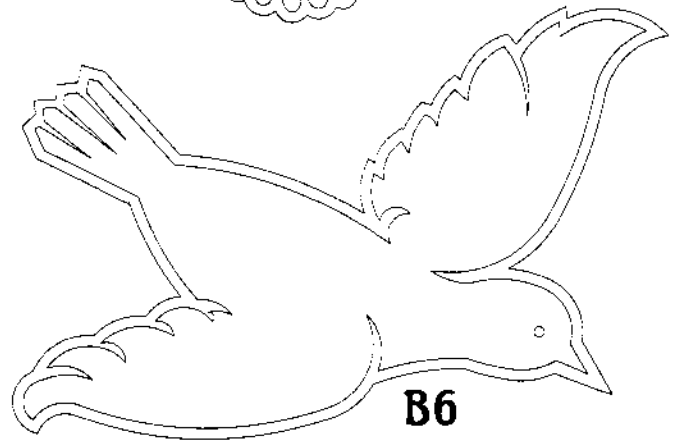

B6

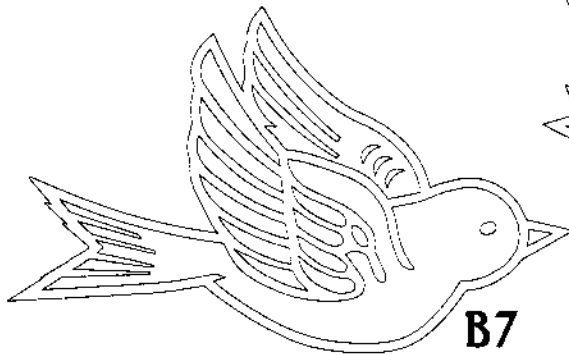

B7

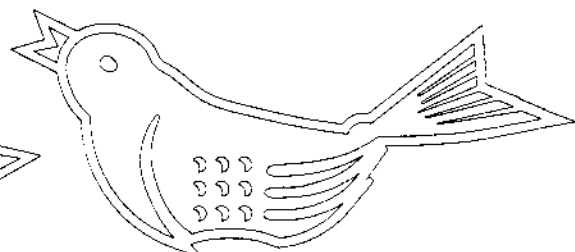

B8

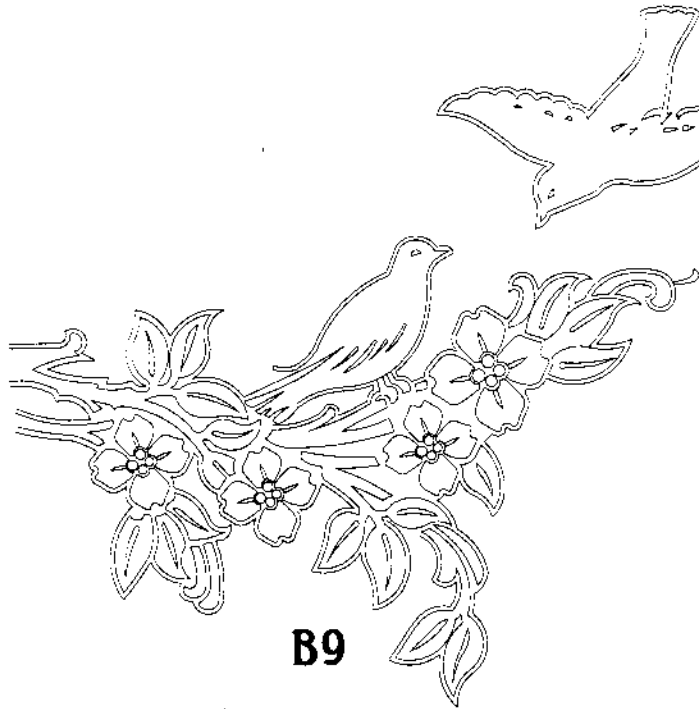

B9

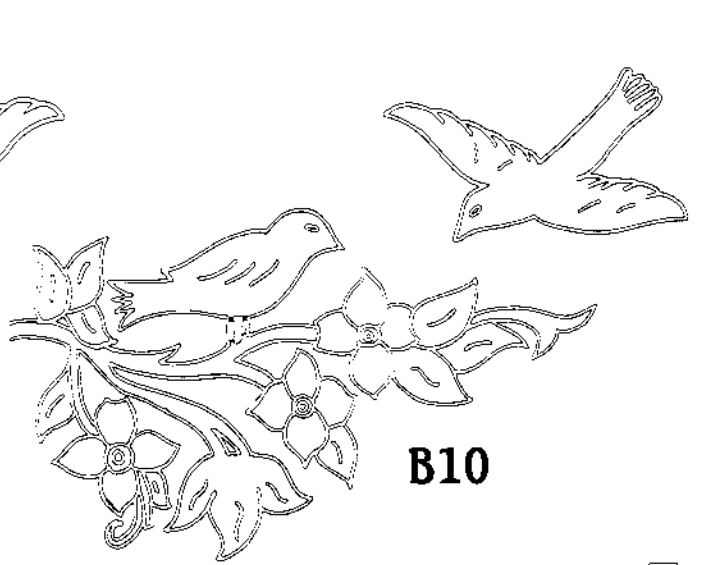

B10

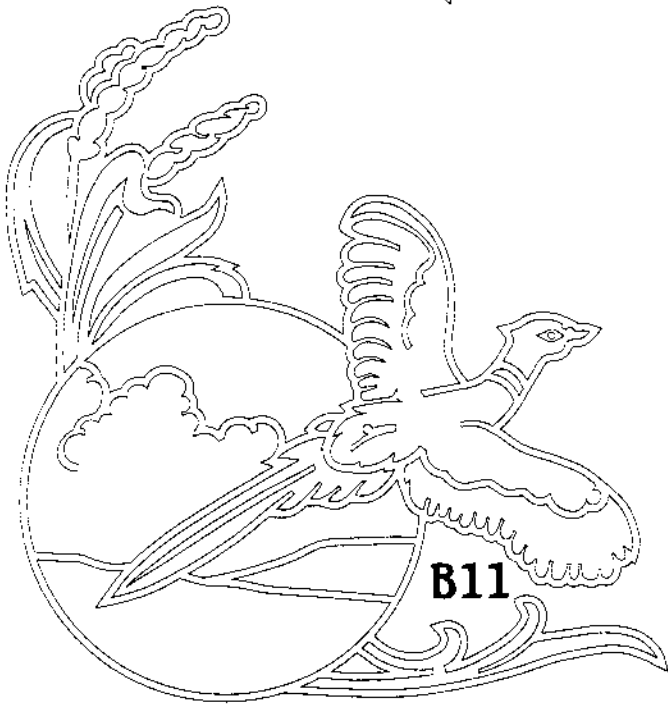

B11

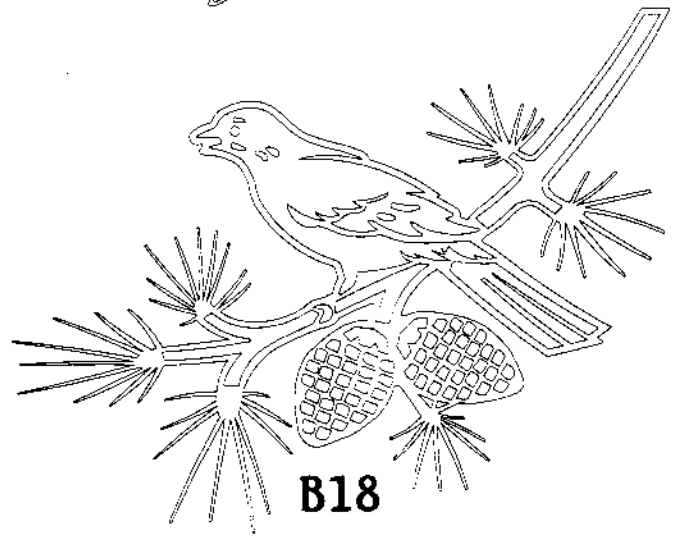

B18

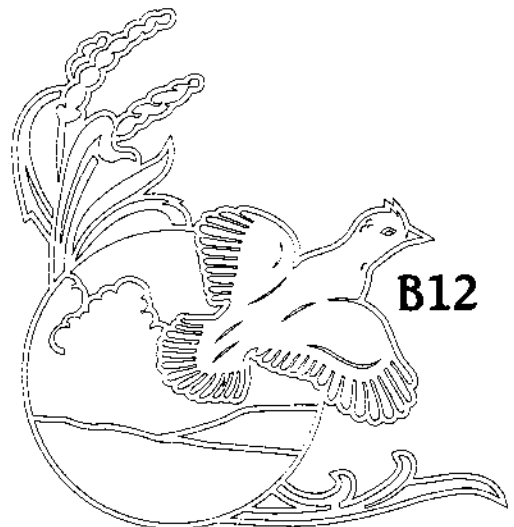

B12

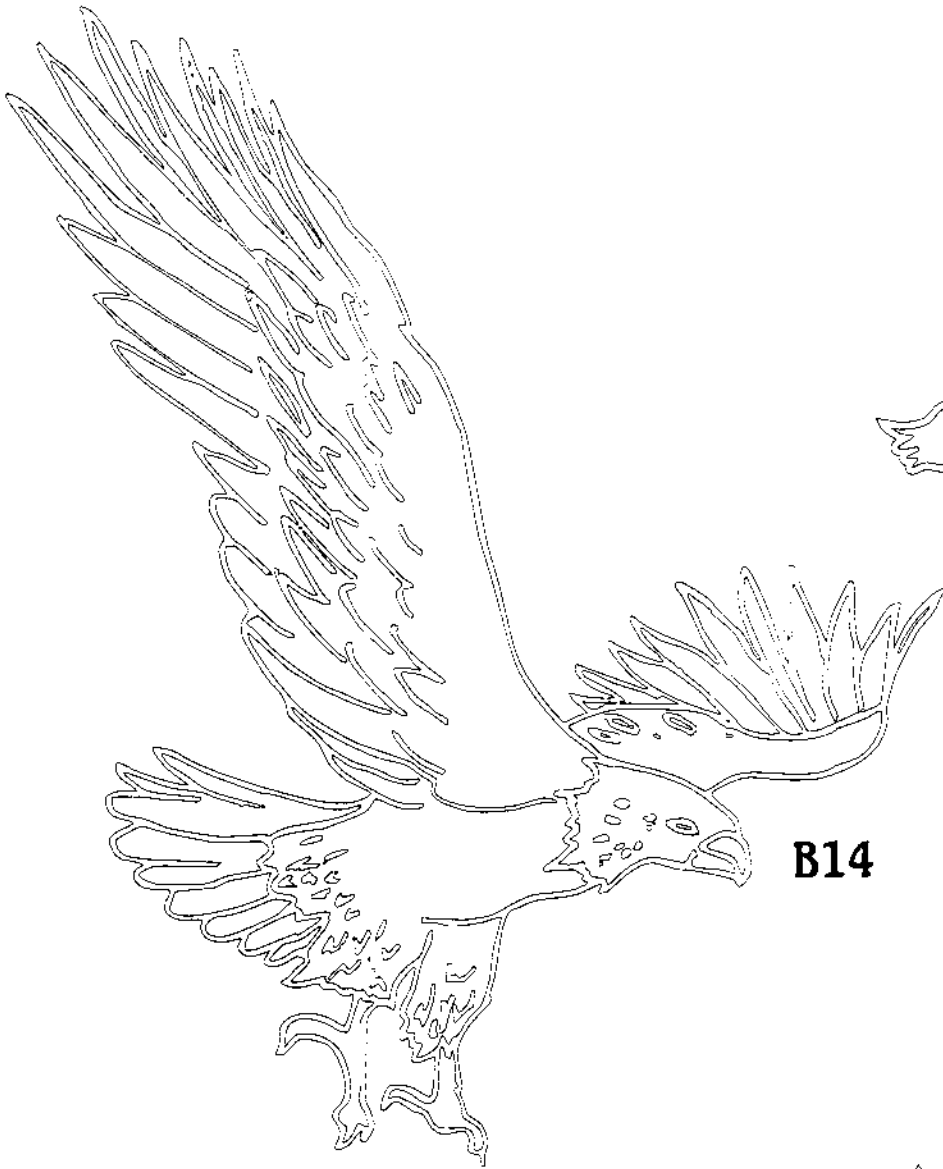

B14



B17

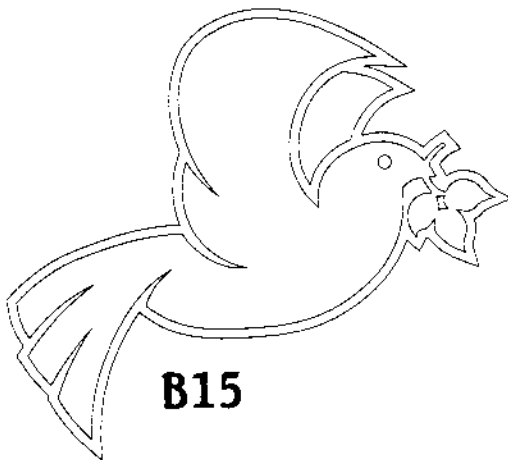

B15

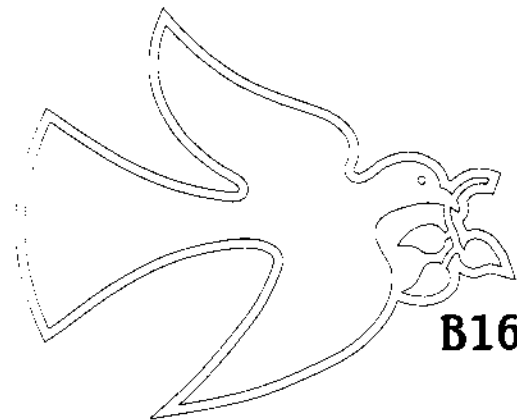

B16



A1



A2



A3



A4

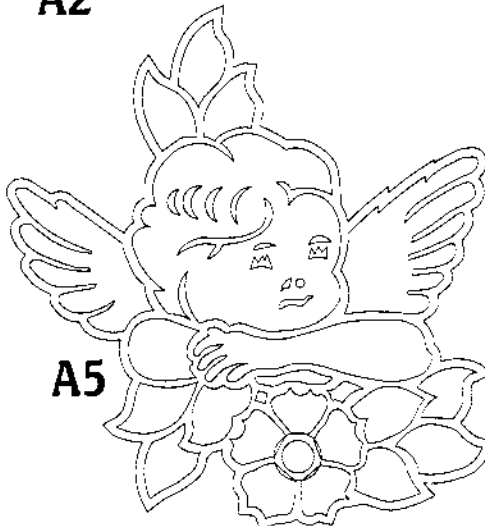

A5

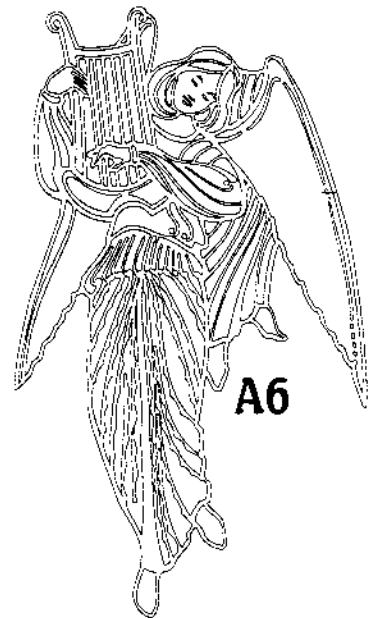

A6



A7



A8



A9



CH1



CH2

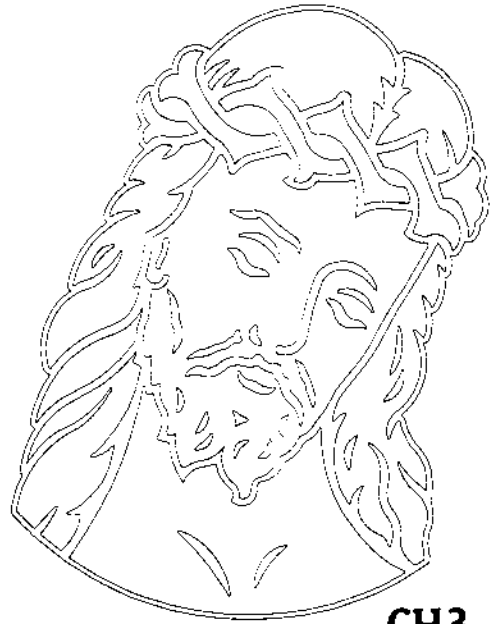

CH3



CH4

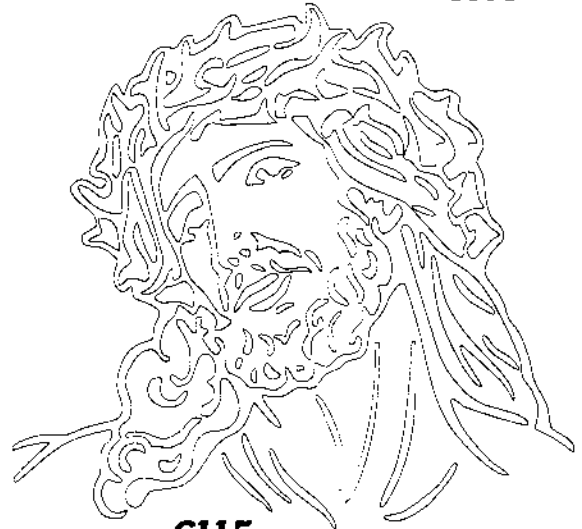

CH5

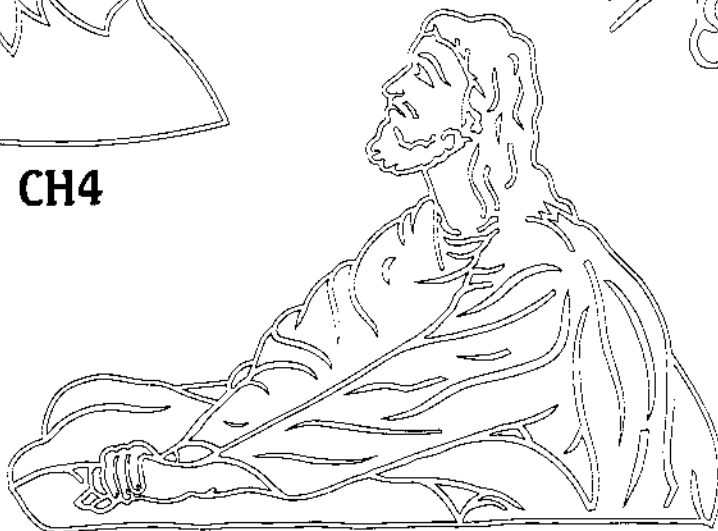

CH6



CH7

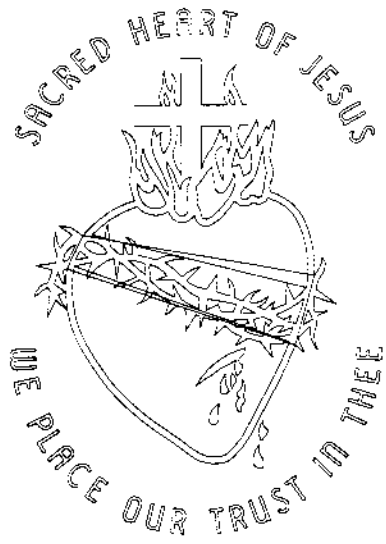

CH8



CH9



CH10



CH11

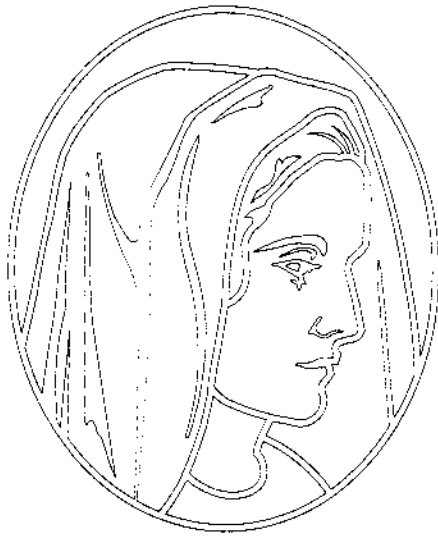

MA1

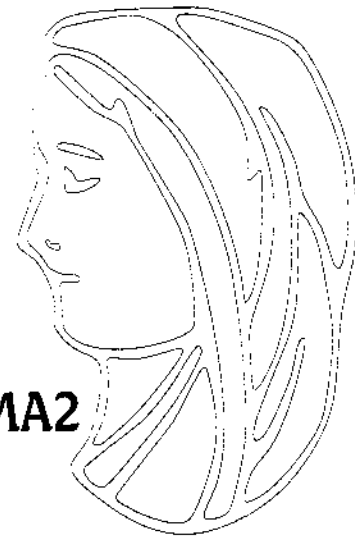

MA2

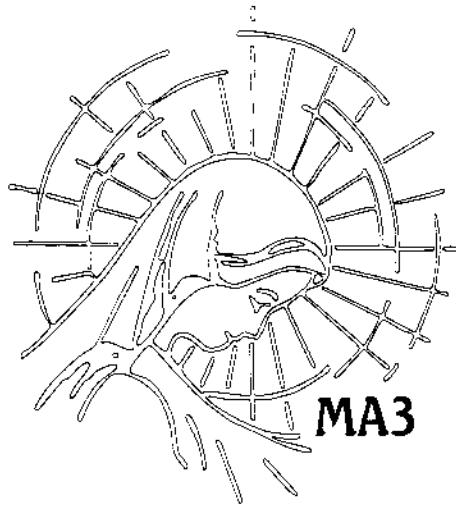

MA3



MA4

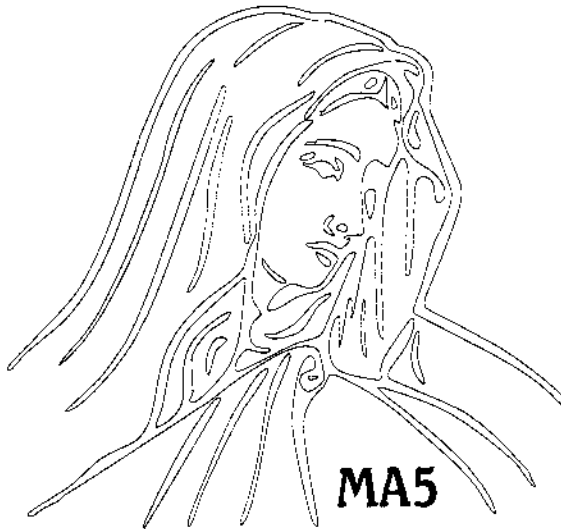

MA5



MA6



MA7

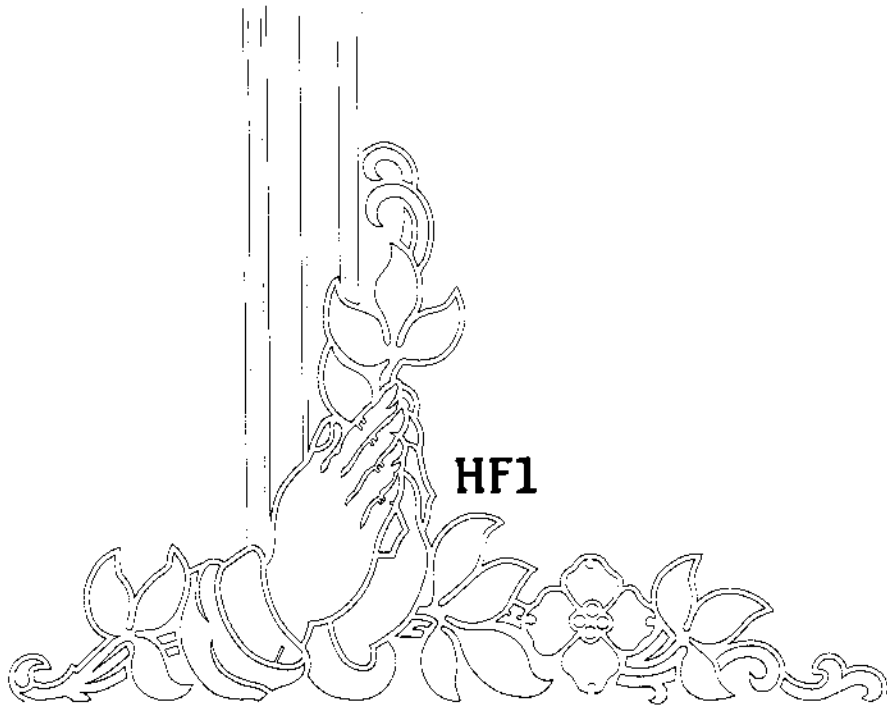

HF1

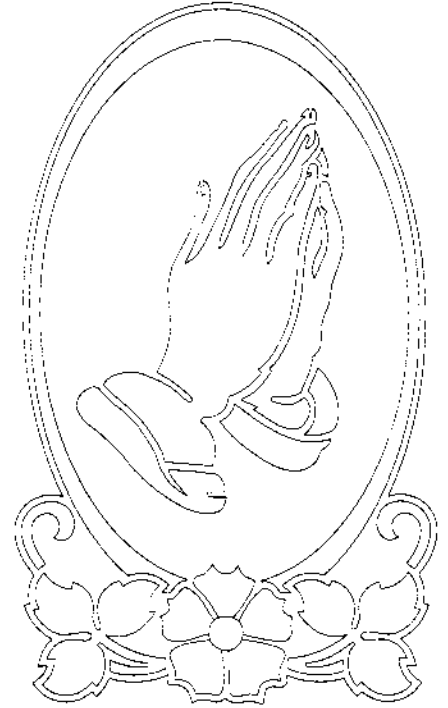

HF2



HF3

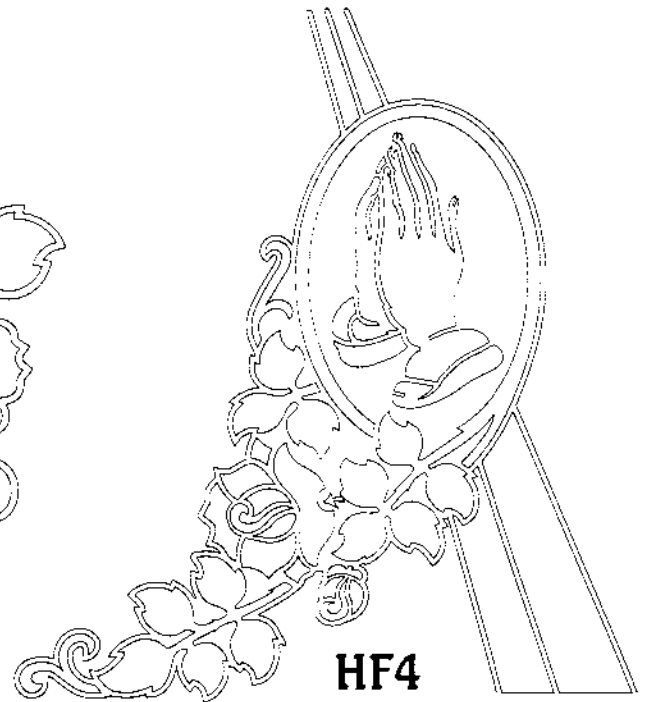

HF4

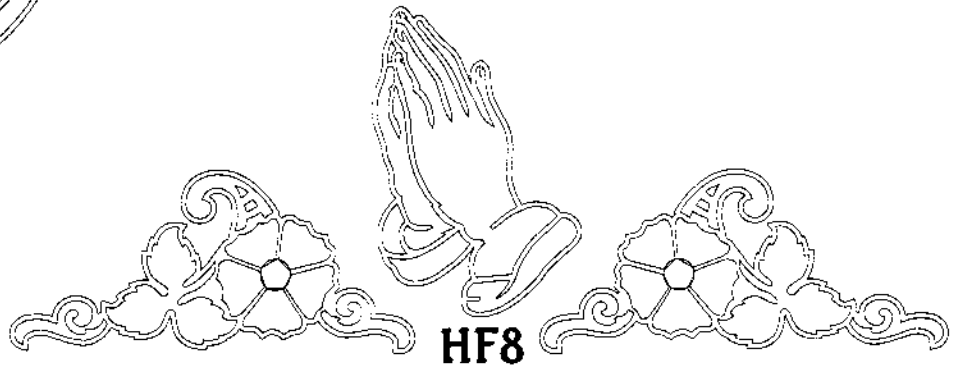
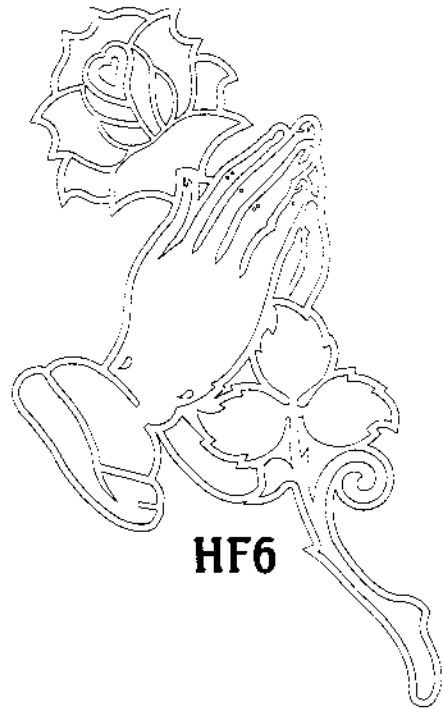
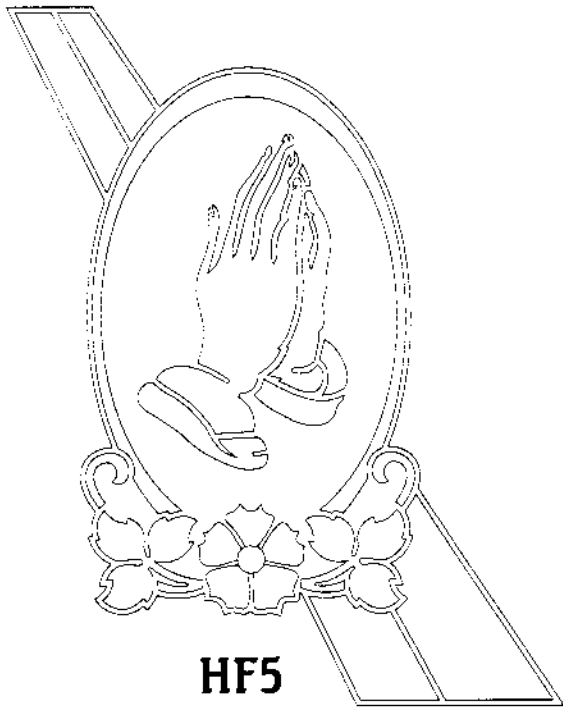

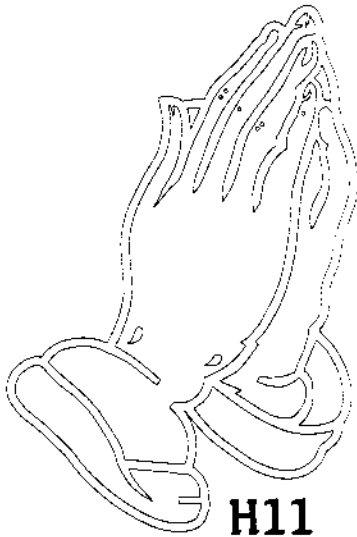

H11



H12

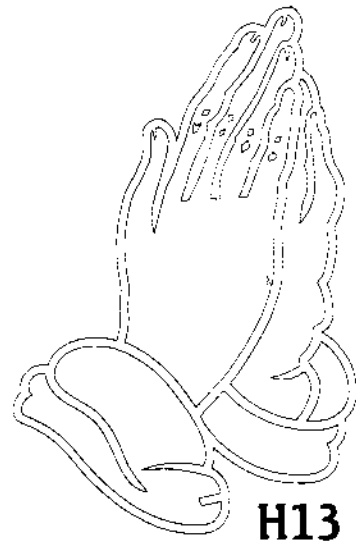

H13

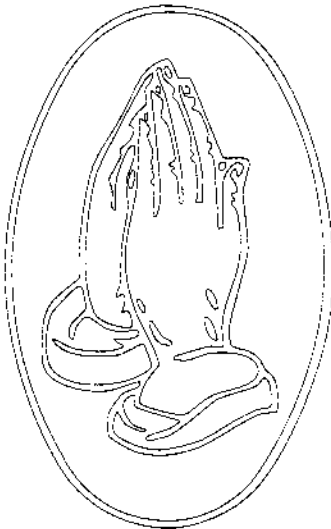

H14

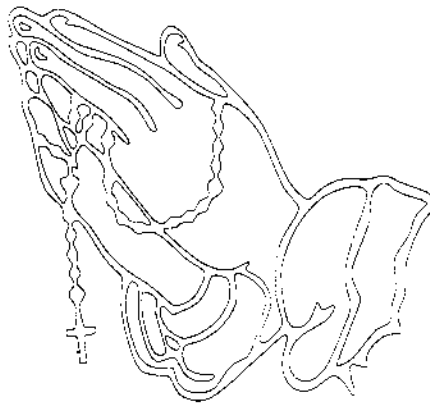

H15

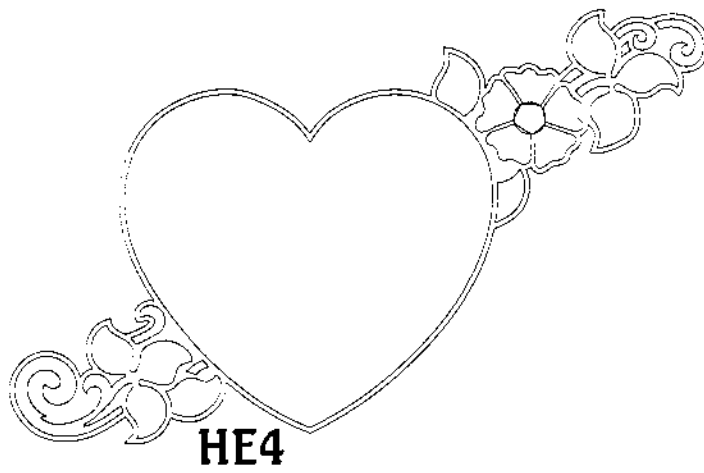
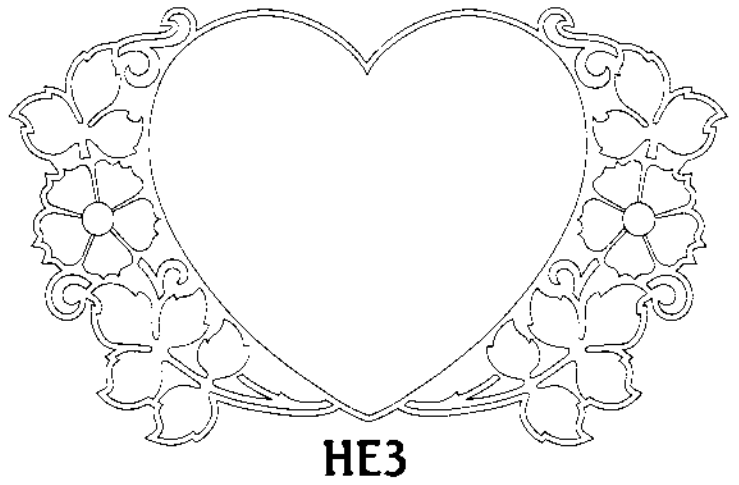
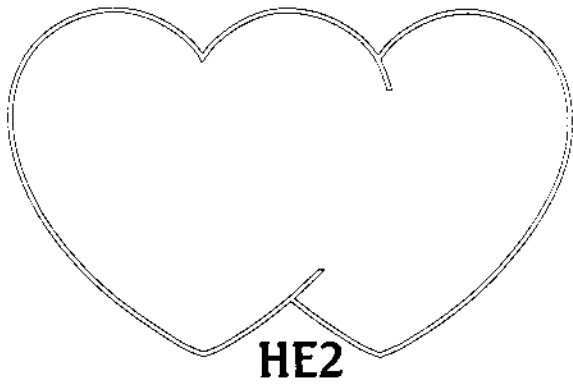
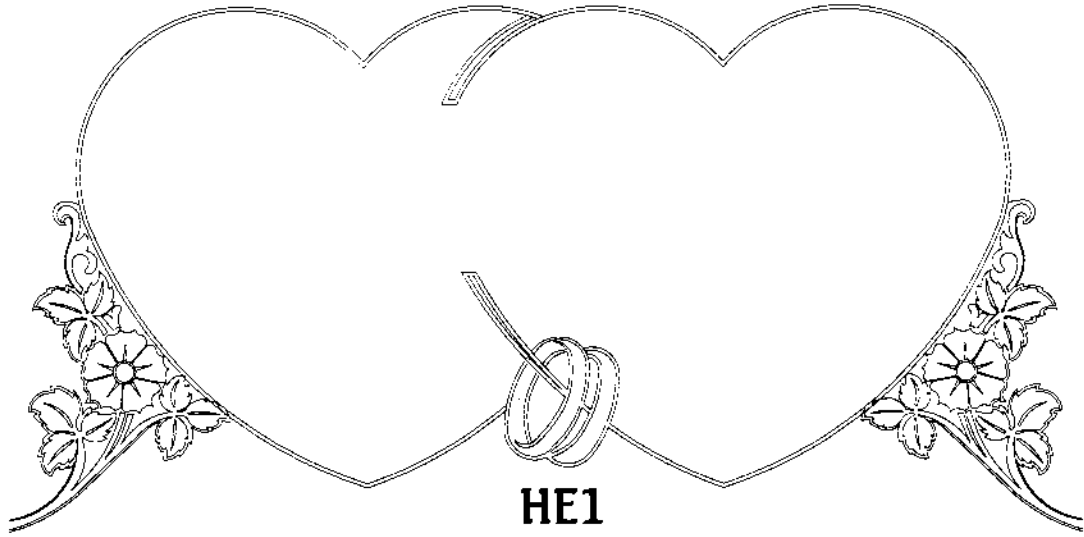

#1

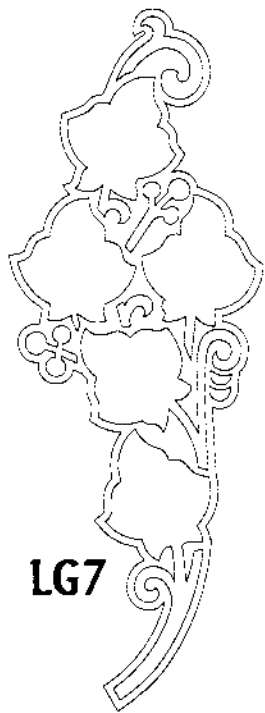

LG7

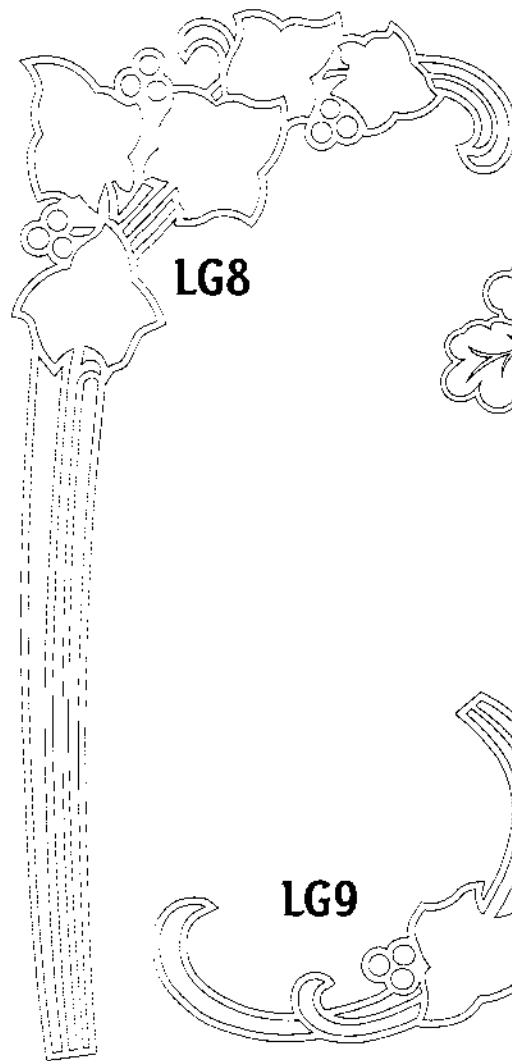

LG8

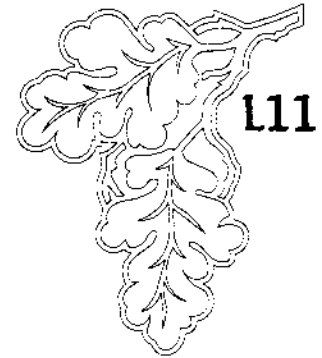

L11

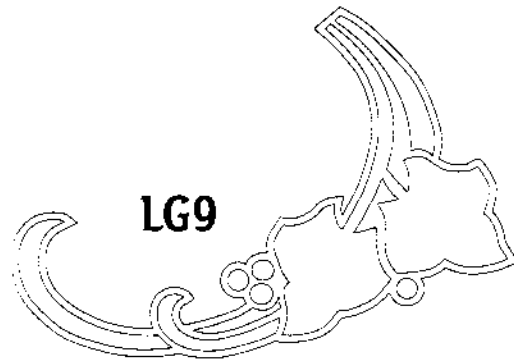

LG9

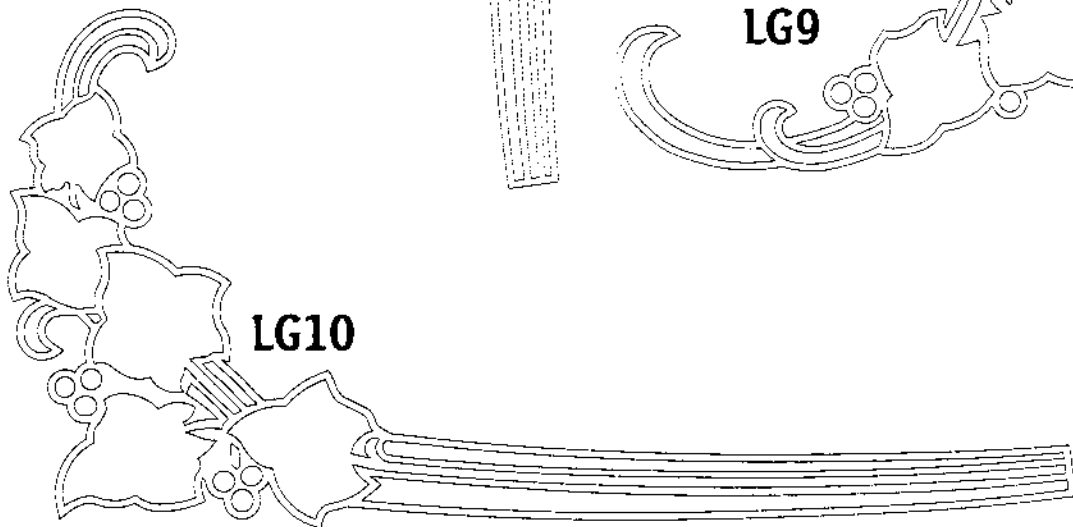

LG10

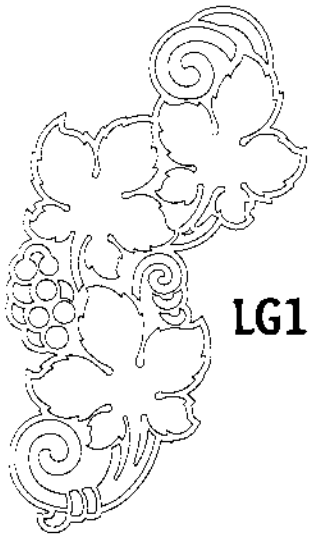

LG1

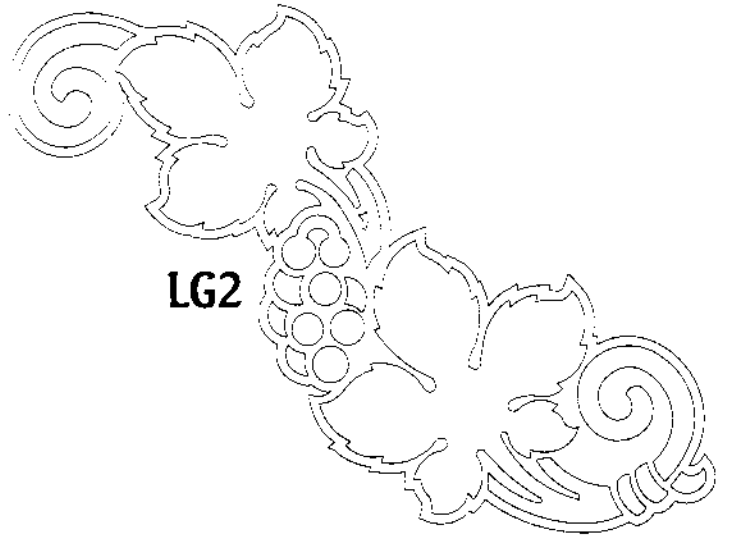

LG2

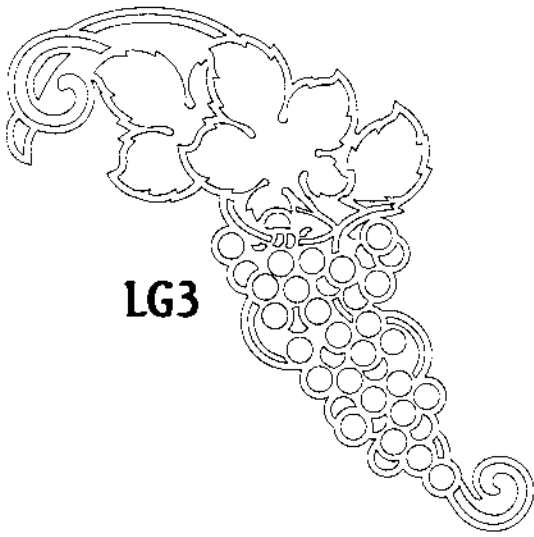

LG3

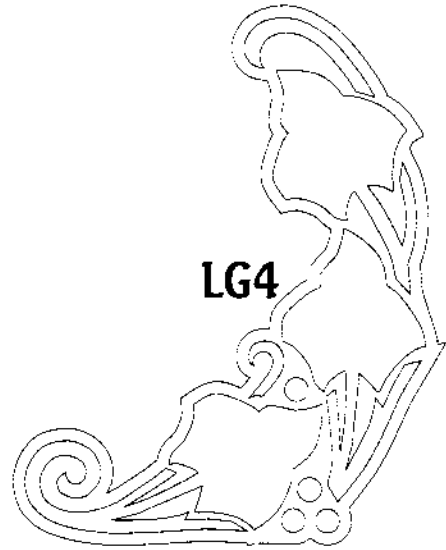

LG4

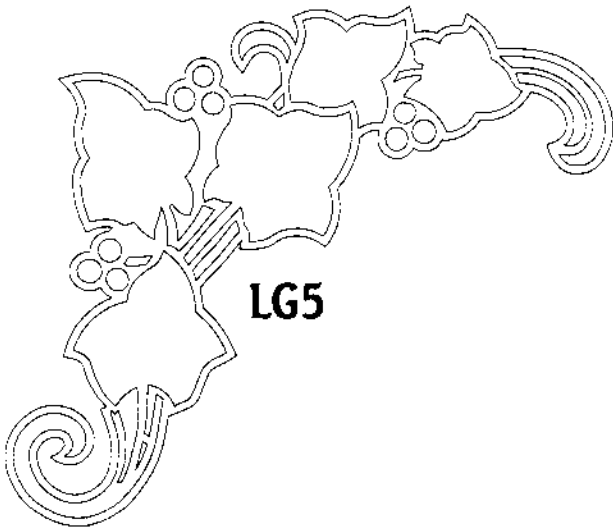

LG5

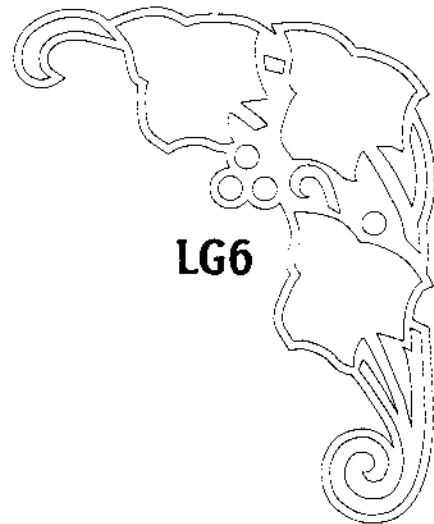

LG6

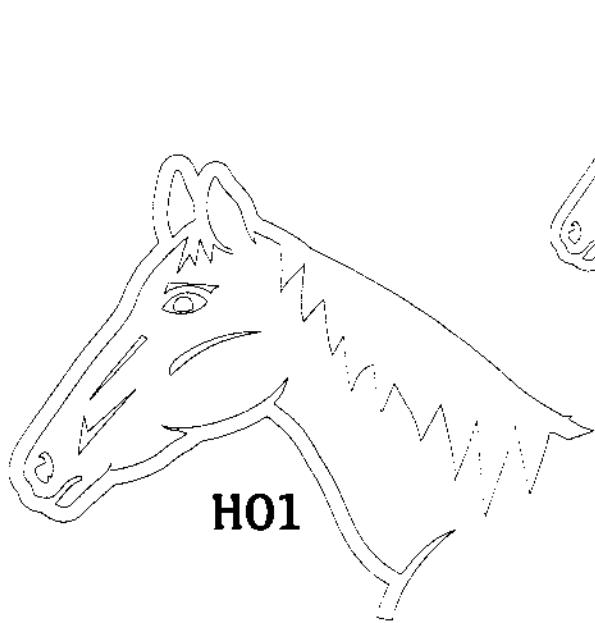

H01

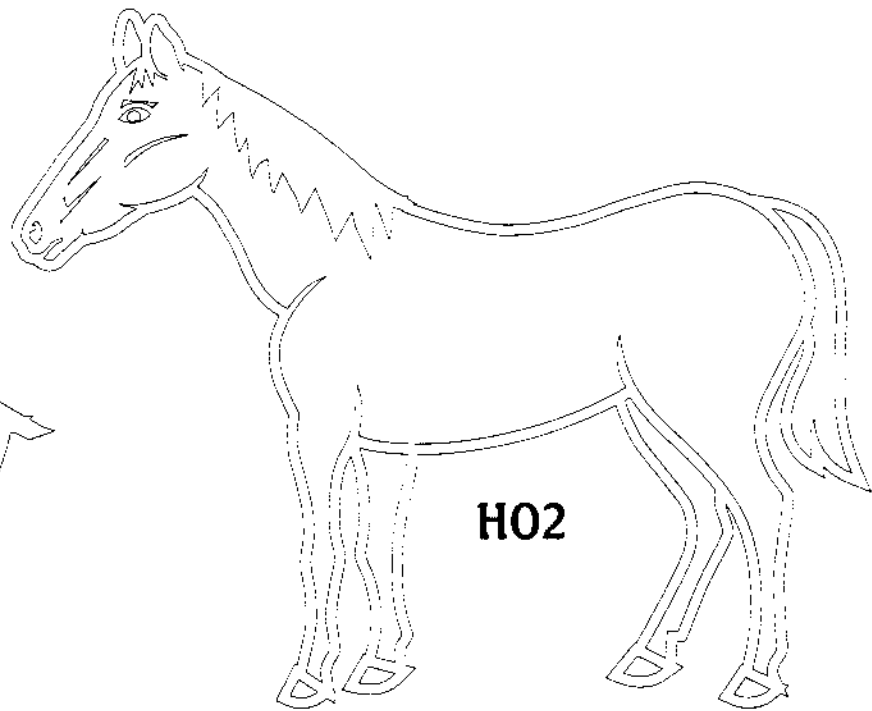

H02

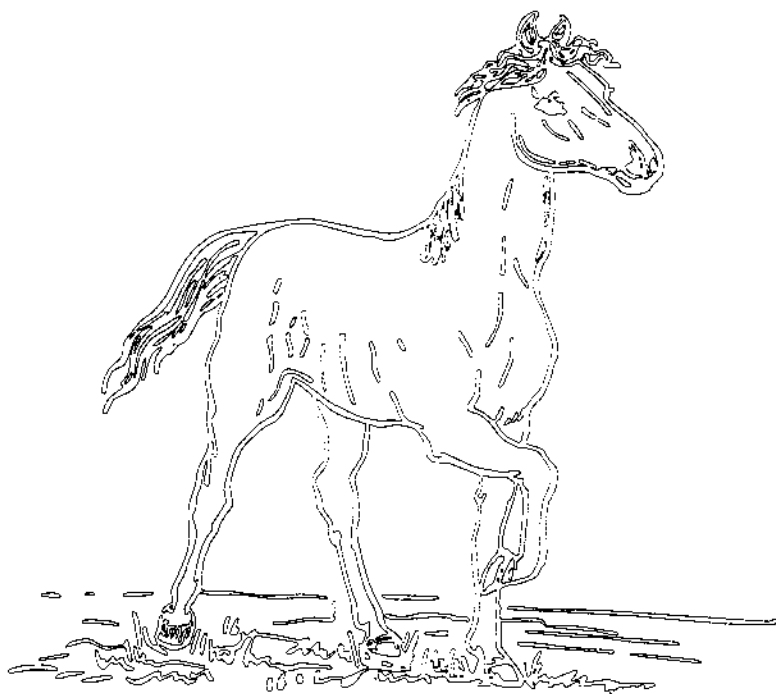

H03

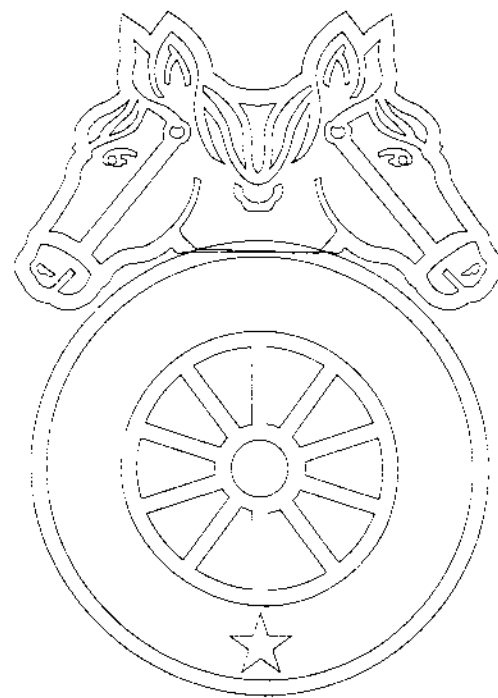

H04

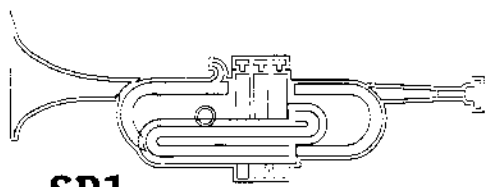

SP1



SP2

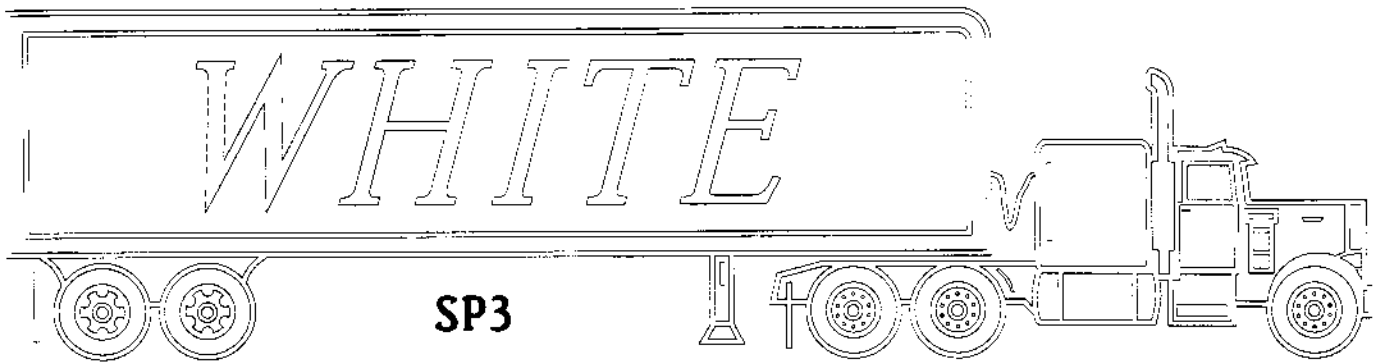

SP3

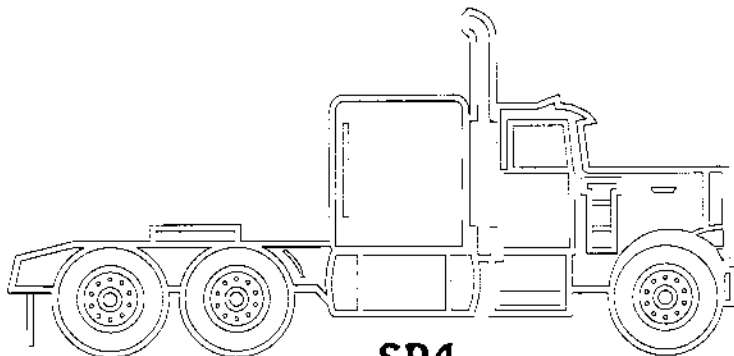

SP4

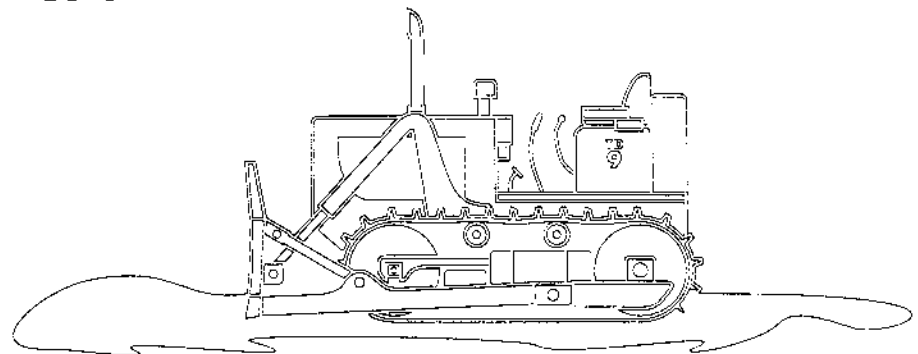

SP5

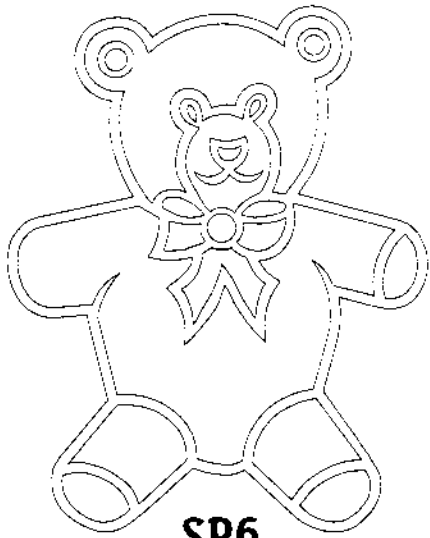

SP6

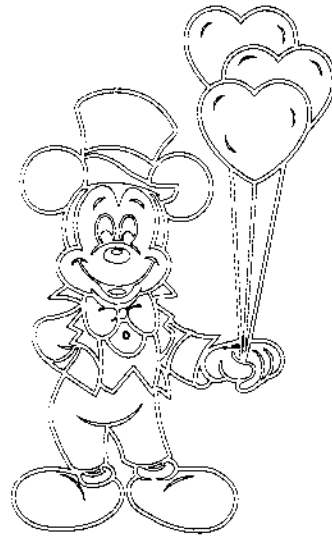

SP7

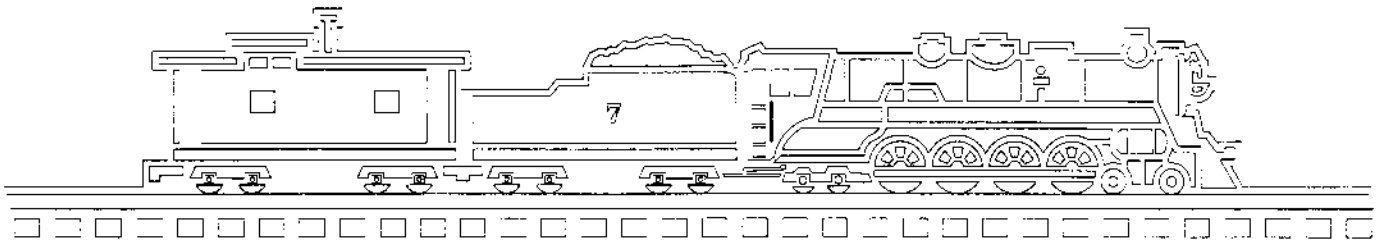

SP8

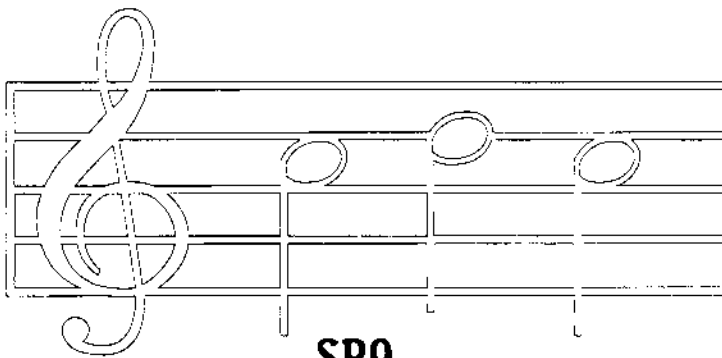

SP9

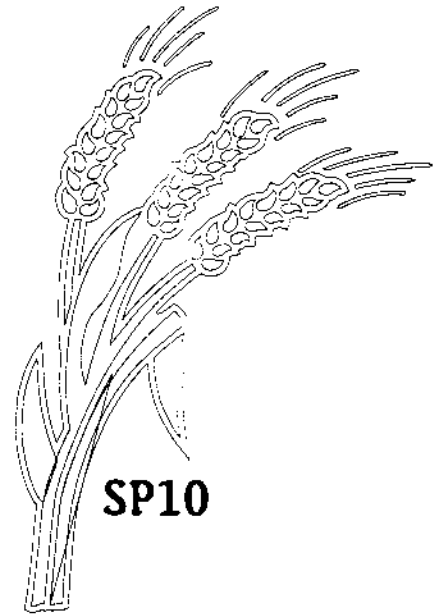

SP10

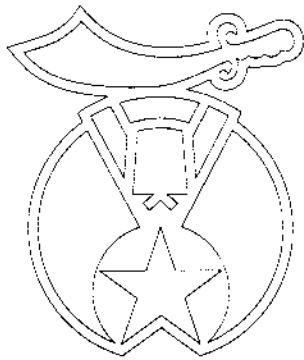

SP11

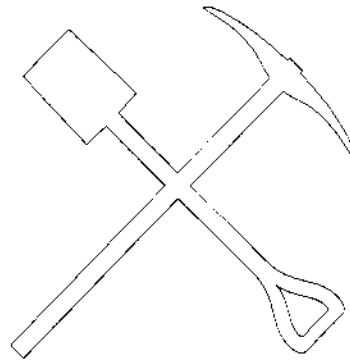

SP12



SP13

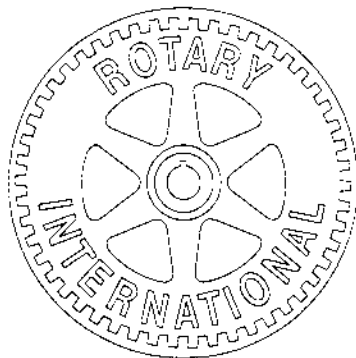

SP14

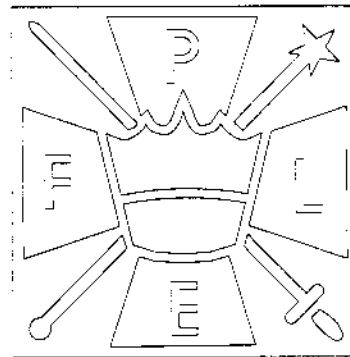

SP15



SP16

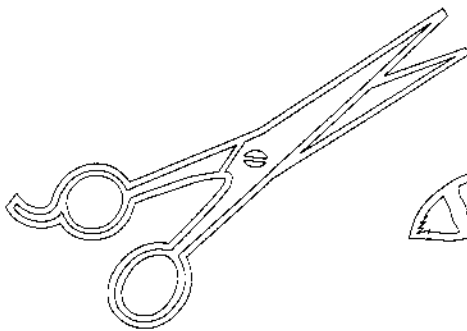

SP17

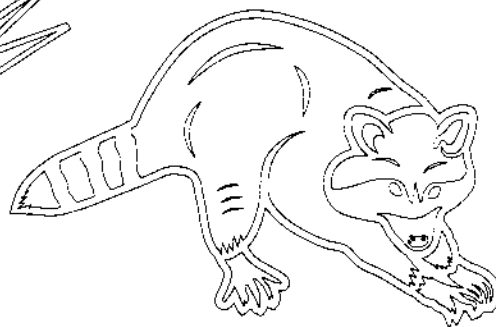

SP18

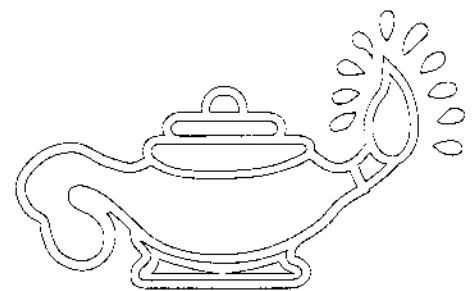

SP19

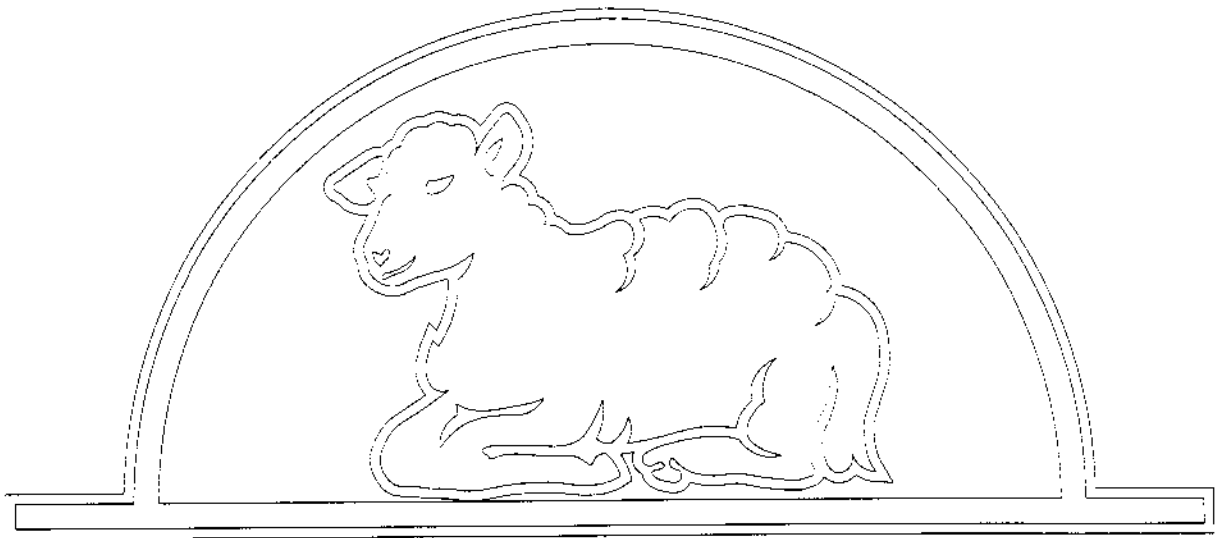

SP20

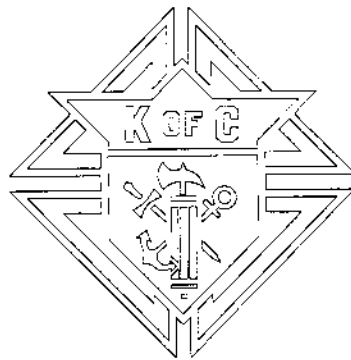

SP21



SP22

#4

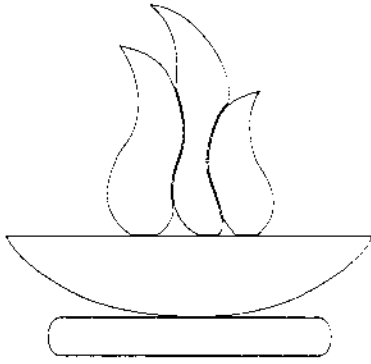

SP25

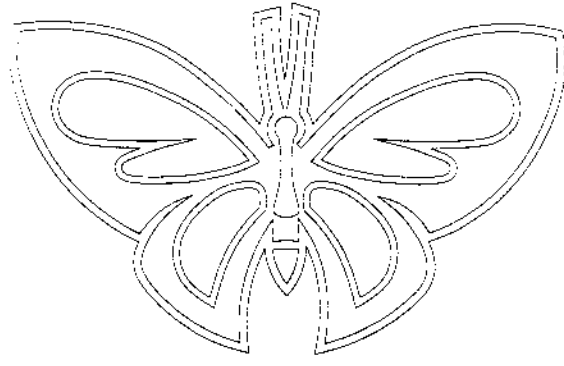

SP26



SP27

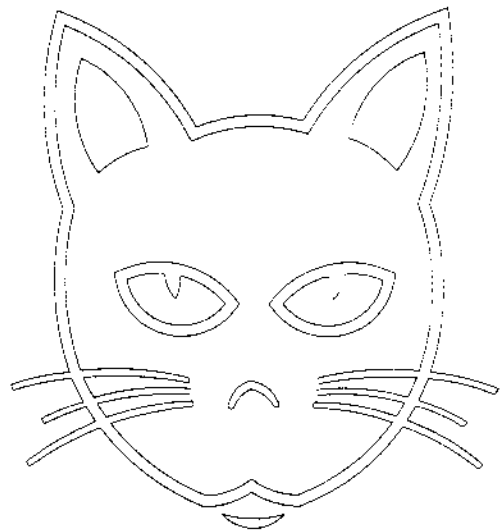

SP28

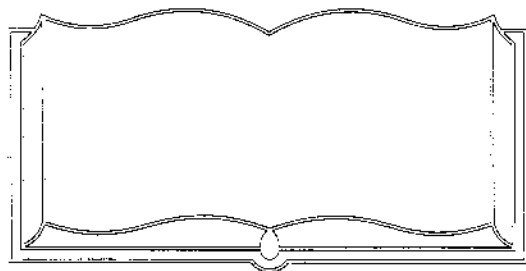

BK1

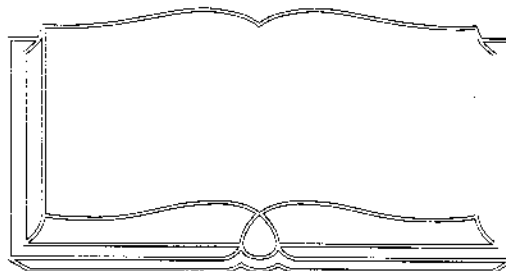

BK2

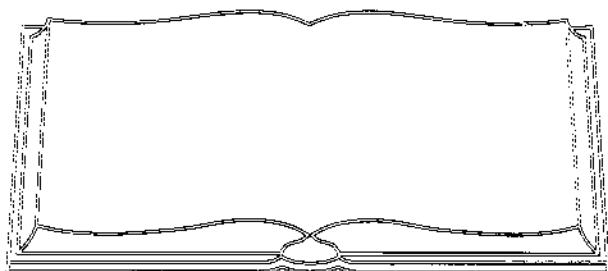

BK3

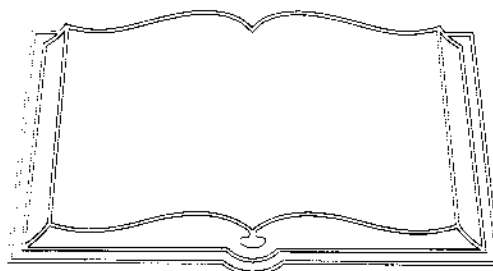

BK4

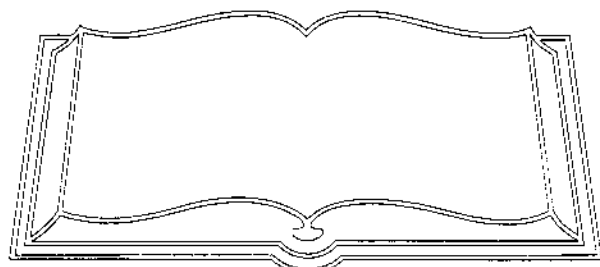

BK5

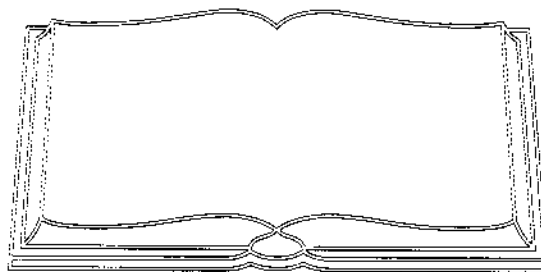

BK6

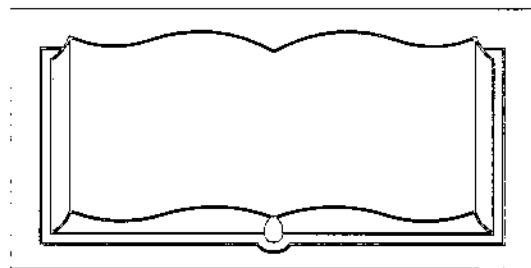

BK7

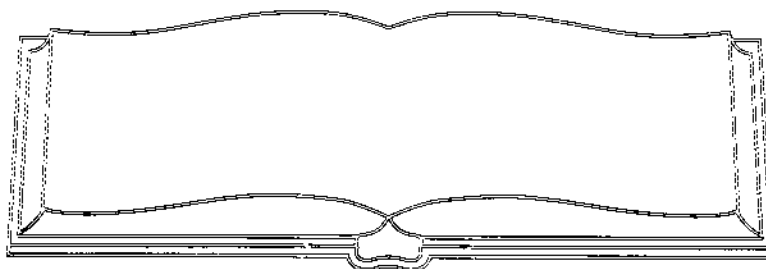

BK8

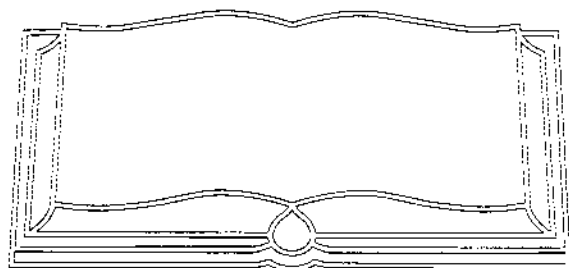

BK9



BK10

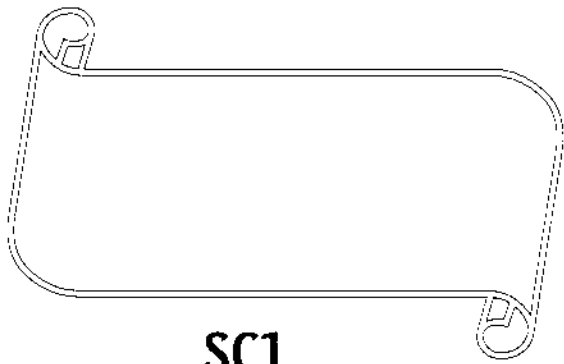

SC1



SC2

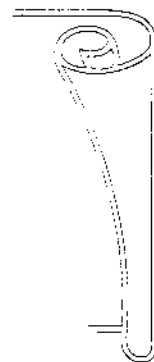

SC3

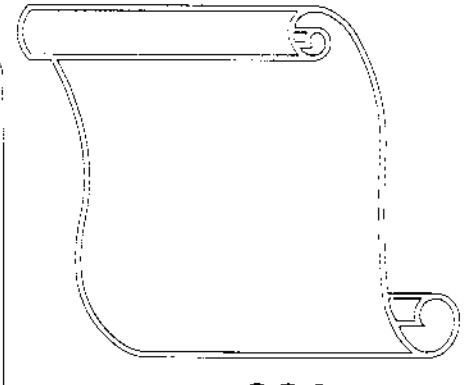

SC4

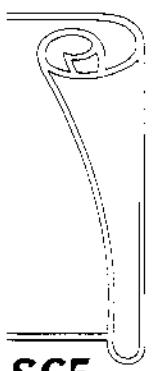

SC5

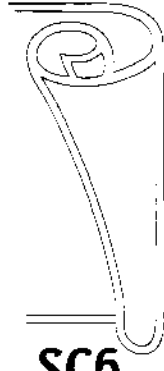

SC6

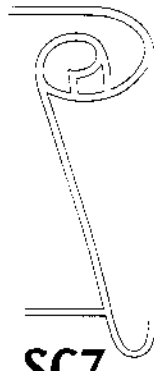

SC7

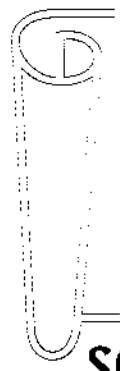

SC8



SC9

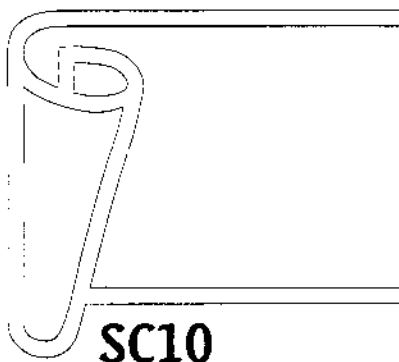

SC10

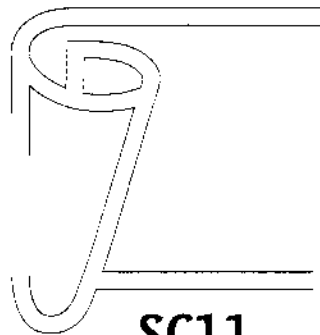

SC11

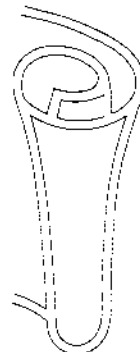

SC12

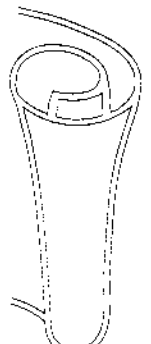

SC13

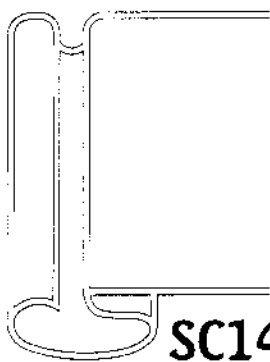

SC14



SC15

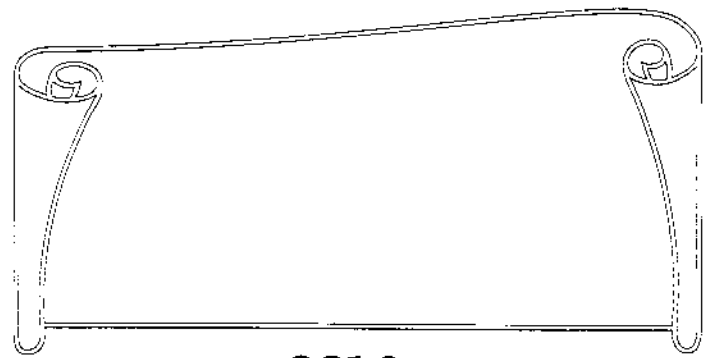

SC16

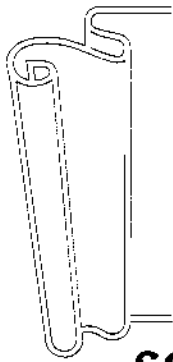

SC17

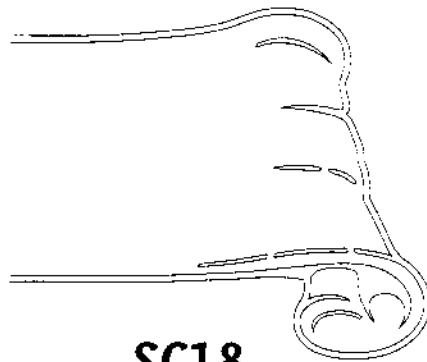

SC18



SC19

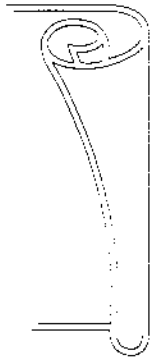

SC20

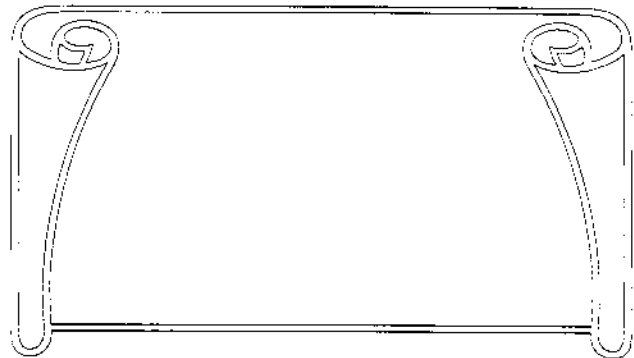

SC21

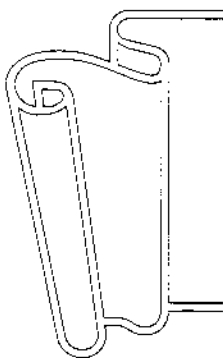

SC22

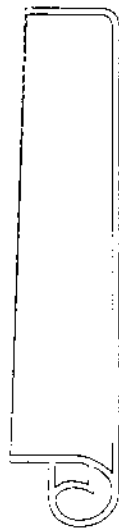

SC23

#2

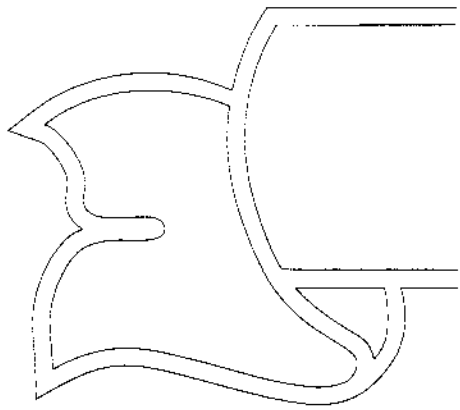

B1

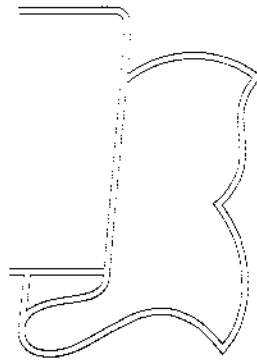

B2

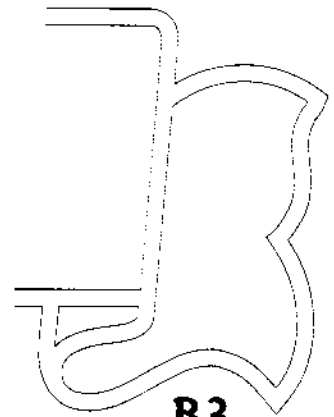

B3

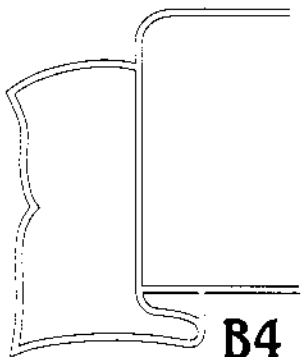

B4

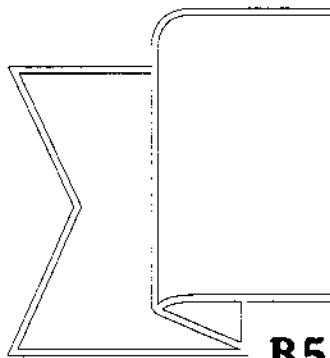

B5

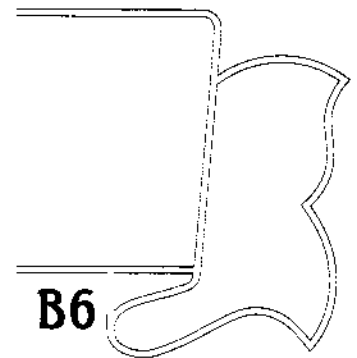

B6

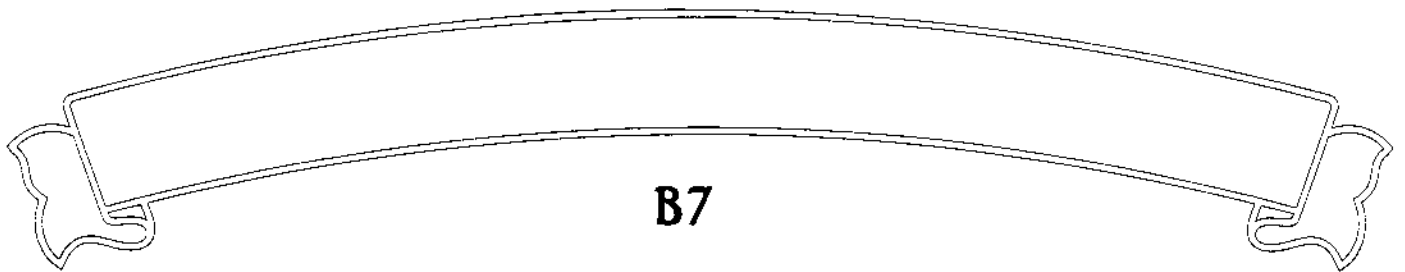

B7