

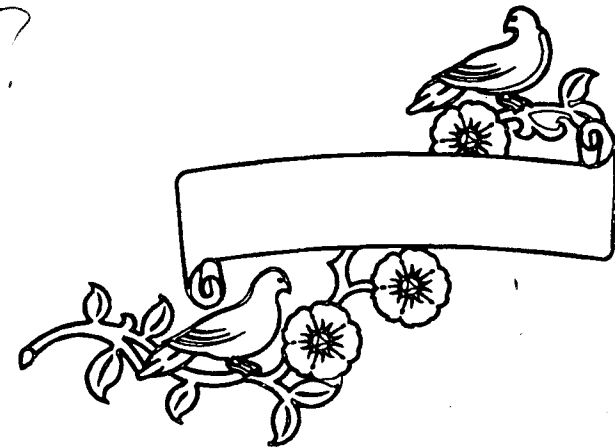

STAFFORD MONUMENTS
WHITBY ONTARIO STD5A001 .CMP



STAFFORD MONUMENTS
WHITBY ONTARIO STD5A002 .CMP



STAFFORD MONUMENTS
WHITBY ONTARIO STD5A003 .CMP

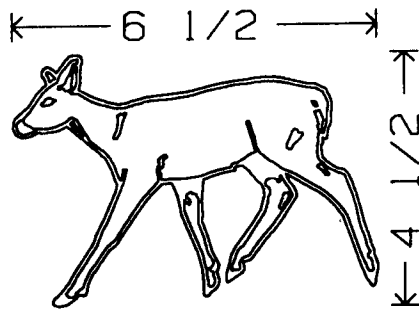

TULSA MONUMENT CO.
TULSA OK STD5A004 .CMP

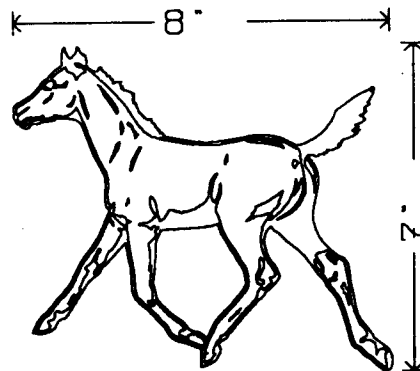

TULSA MONUMENT CO.
TULSA OK STD5A005 .CMP



TULSA MONUMENT CO.
TULSA OK STD5A006 .CMP

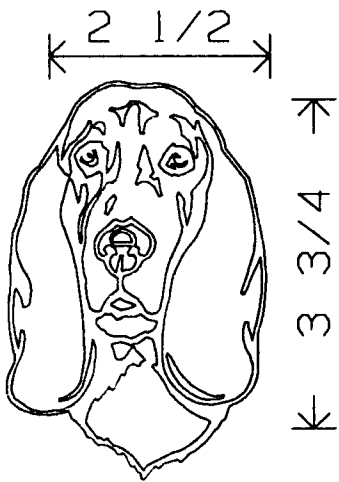

TULSA MONUMENT CO.
TULSA OK STD5A007.CMP

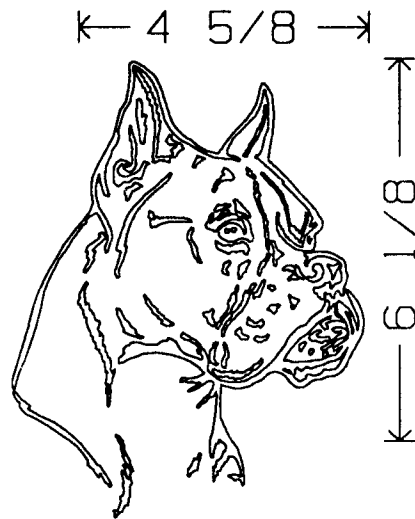

TULSA MONUMENT CO.
TULSA OK STD5A008.CMP



TULSA MONUMENT CO.
TULSA OK STD5A009.CMP

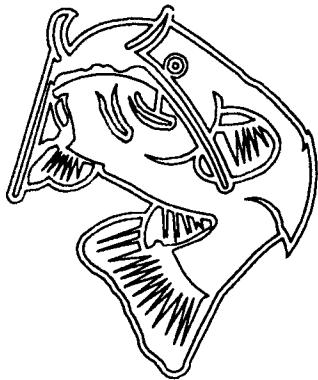

CAMDEN MONUMENT CO.
CAMDEN AR STD5A010.CMP

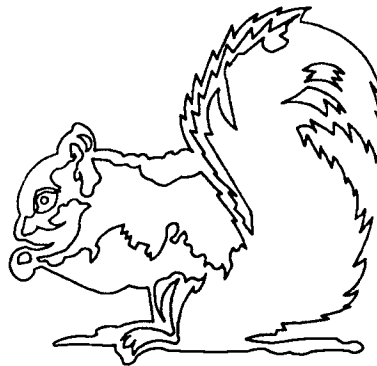

CAMDEN MONUMENT CO.
CAMDEN AR STD5A011.CMP

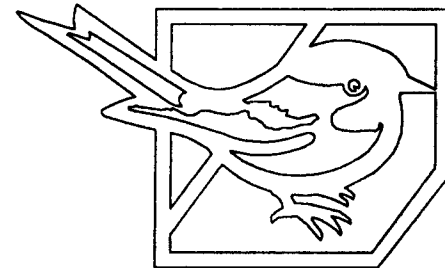

PIQUA GRANITE & MARBLE
PIQUA OH STD5A012.CMP



PIQUA GRANITE & MARBLE
PIQUA OH STD5A013.CMP



PIQUA GRANITE & MARBLE
PIQUA OH STD5A014.CMP



SAXON GRANITE
ELBERTON GA STD5A017.CMP

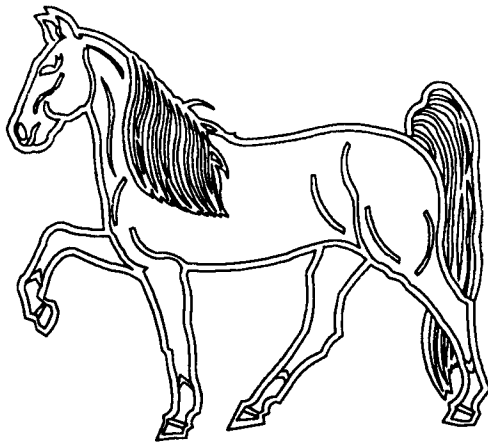

SAXON GRANITE
ELBERTON GA STD5A016.CMP

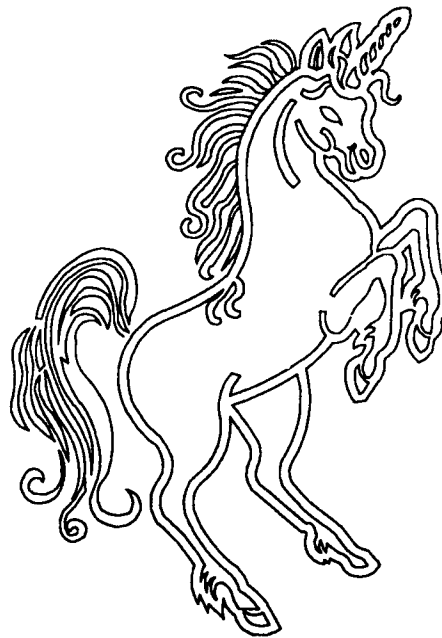

SAXON GRANITE
ELBERTON GA STD5A015.CMP



SAXON GRANITE
ELBERTON GA STD5A018.CMP

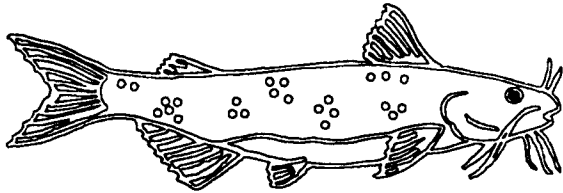

STANDARD GRANITE
ELBERTON GA  STD5A019 .CMP

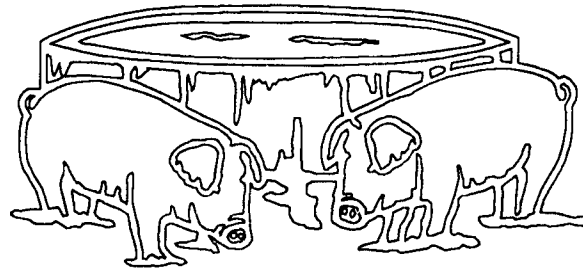

DAKOTA MONUMENT
FARGO ND STD5A020 .CMP

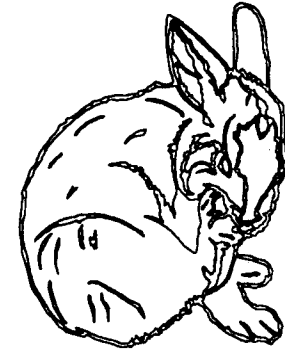

DAKOTA MONUMENT
FARGO ND
STD5A021 .CMP

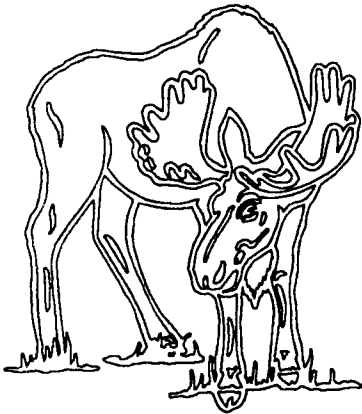

DAKOTA MONUMENT
FARGO ND STD5A022 .CMP



DAKOTA MONUMENT
FARGO ND STD5A023 .CMP



DAKOTA MONUMENT
FARGO ND STD5A024 .CMP





DAKOTA MONUMENT
FARGO ND

STD5A025 .CMP

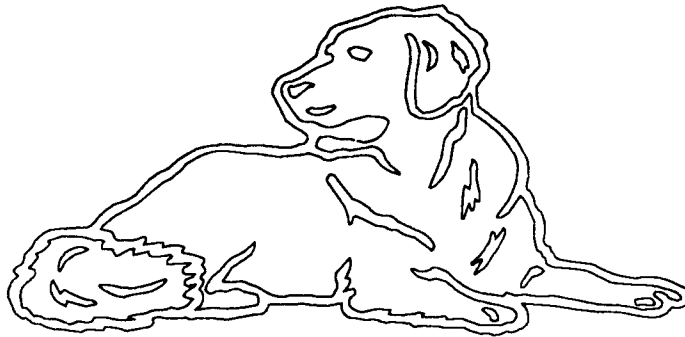

DAKOTA MONUMENT
FARGO ND

STD5A026 .CMP

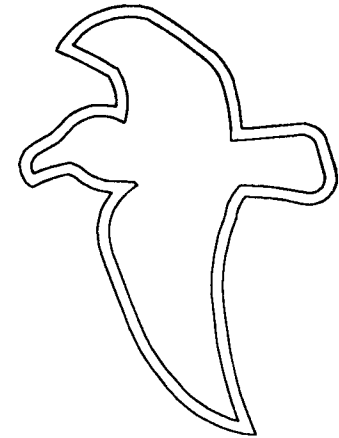

CENTRAL GRANITE CO.
ELBERTON GA

STD5A027 .CMP

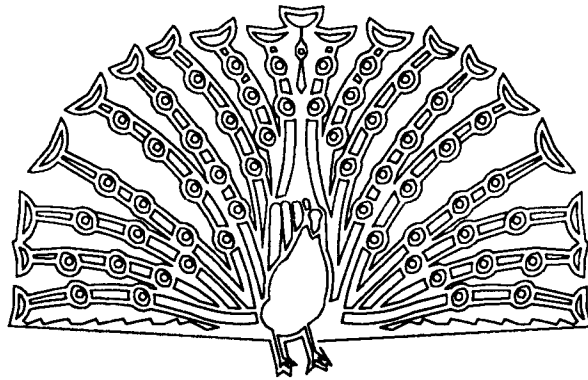

N.C. MARBLE & GRANITE
CLINTON NC

STD5A028 .CMP

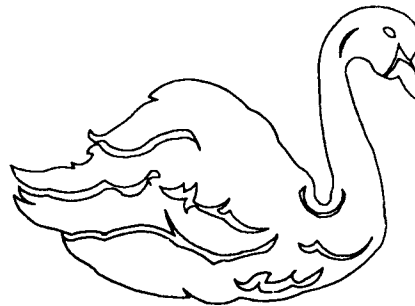

N.C. MARBLE & GRANITE
CLINTON NC

STD5A029 .CMP



10 x 12.5
ARCHIE MON. & STONE
WATERTOWN WI

STD5A030 .CMP



11 x 10

ARCHIE MON. & STONE
WATERTOWN WI

STD5A031.CMP

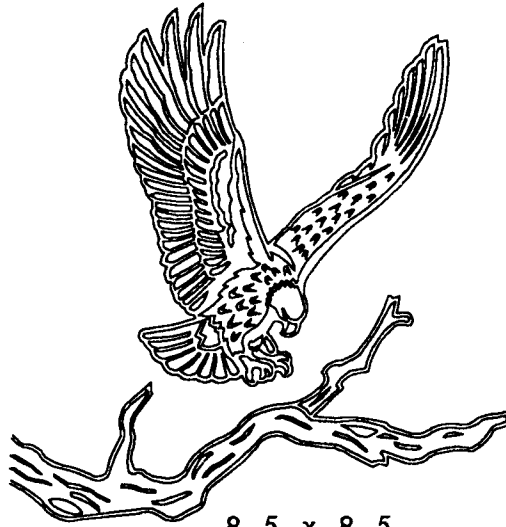

8.5 x 8.5

ARCHIE MON. & STONE
WATERTOWN WI

STD5A032.CMP

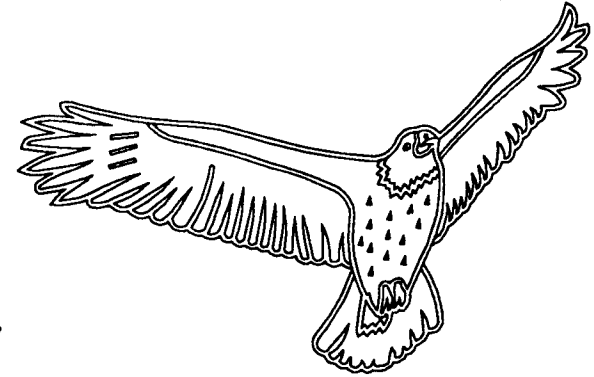

DAWSON MONUMENT CO.

WINFIELD KS STD5A033.CMP

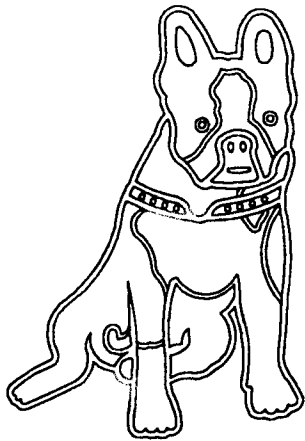

DAWSON MONUMENT CO.
WINFIELD KS

STD5A034.CMP



DAWSON MONUMENT CO.
WINFIELD KS

STD5A035.CMP

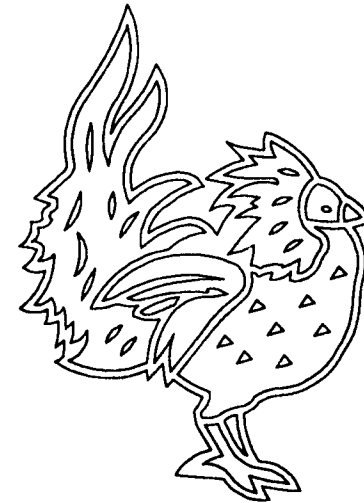

DAWSON MONUMENT CO.
WINFIELD KS

STD5A036.CMP

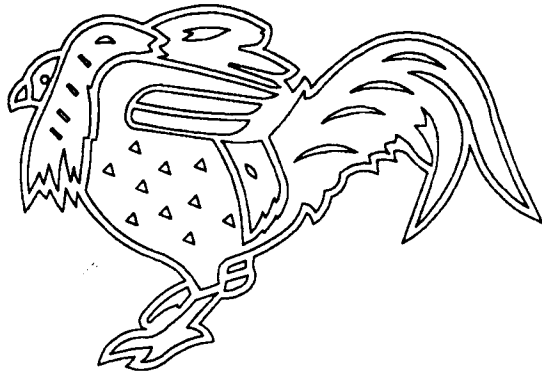

DAWSON MONUMENT CO.
WINFIELD KS

STD5A037.CMP



DAWSON MONUMENT CO.
WINFIELD KS

STD5A038.CMP

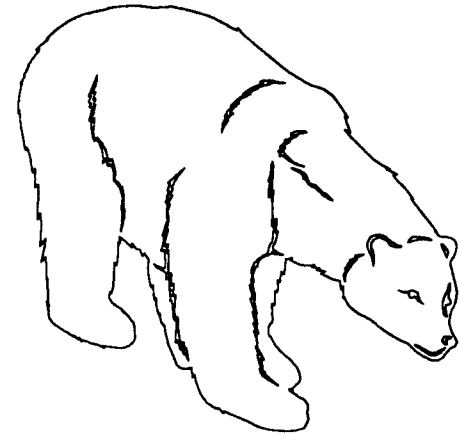

GRANITE LACROIX
VIMONT-LAVAL QUEBEC

STD5A039.CMP

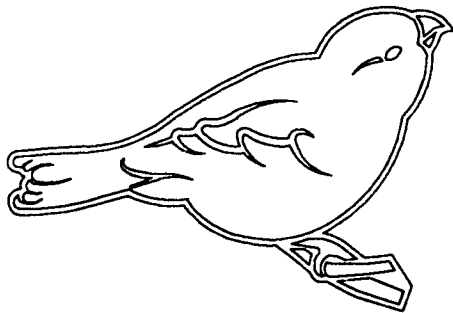

GRANITE LACROIX
VIMONT-LAVAL QUEBEC

STD5A040.CMP



GRANITE LACROIX
VIMONT-LAVAL QUEBEC

STD5A041.CMP

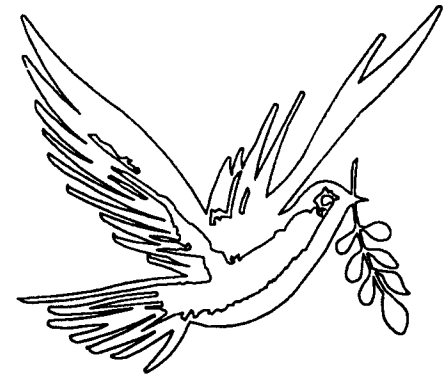

GRANITE LACROIX
VIMONT-LAVAL QUEBEC

STD5A042.CMP

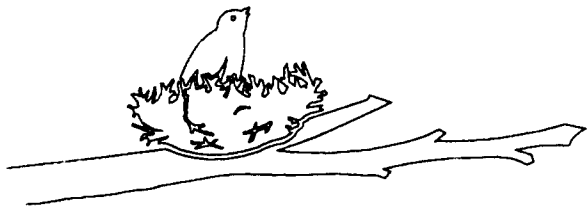

GRANITE LACROIX
VIMONT-LAVAL QUEBEC
STD5A043 .CMP



AMITE MARBLE & GRANITE
AMITE LA STD5A044 .CMP



EDWIN F. NICKOL
VERSAILLES OH STD5A045 .CMP

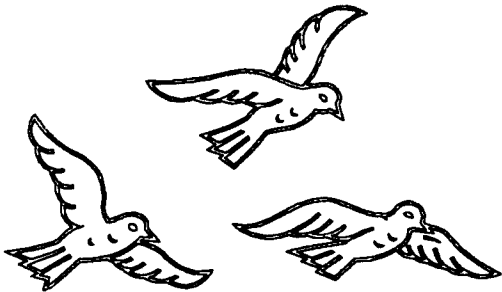

EDWIN F. NICKOL
VERSAILLES OH STD5A046 .CMP



EDWIN F. NICKOL
VERSAILLES OH STD5A047 .CMP

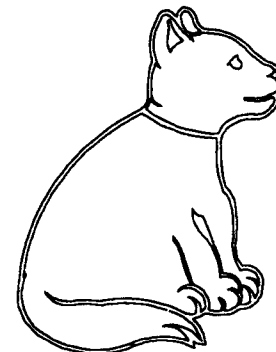

ERIE CITY MEMORIALS
ERIE PA STD5A048 .CMP

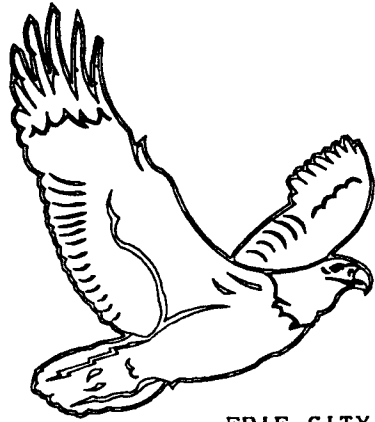

ERIE CITY MEMORIALS
ERIE PA
STD5A049 .CMP

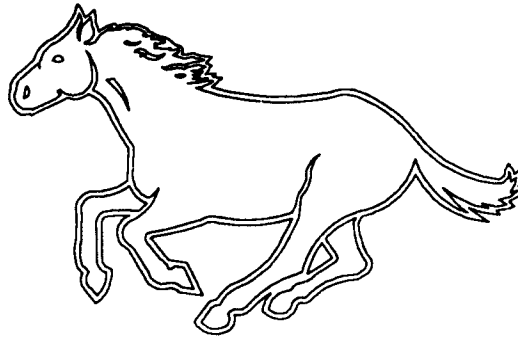

ERIE CITY MEMORIALS
ERIE PA
STD5A050 .CMP

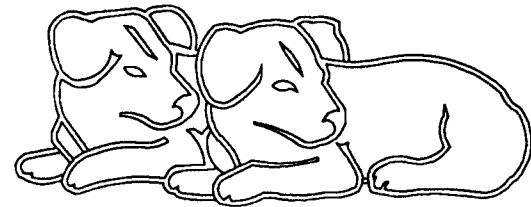

MASTERCARVED MEMORIALS
CLAY CENTER KS
STD5A051 .CMP

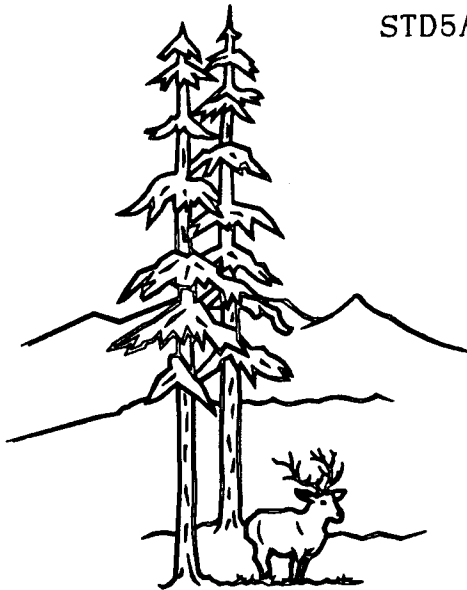

MASTERCARVED MEMORIALS
CLAY CENTER KS
STD5A052 .CMP

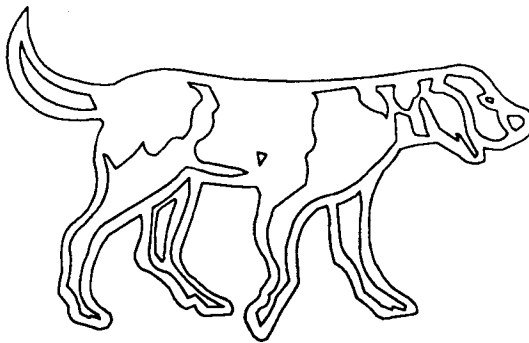

WOODWARD MONUMENT
VICI OK
STD5A053 .CMP

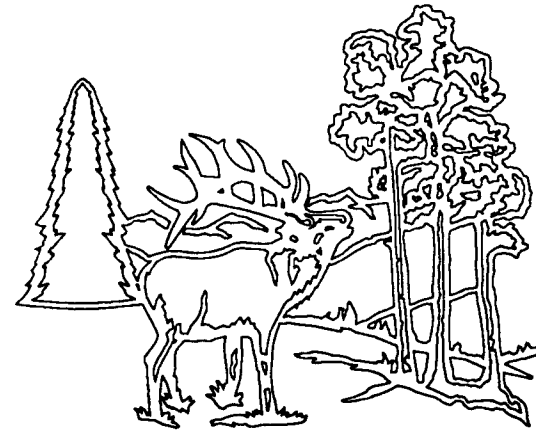

WOODWARD MONUMENT
VICI OK
STD5A054 .CMP

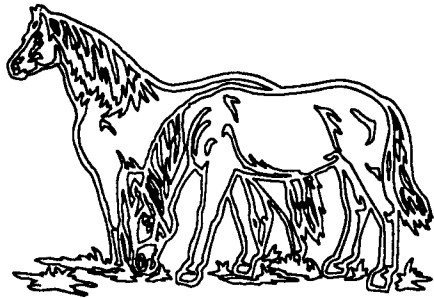

WOODWARD MONUMENTS
VICI OK STD5A055.CMP

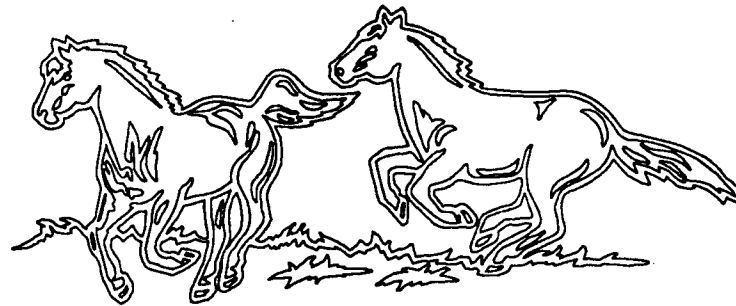

WOODWARD MONUMENTS
VICI OK STD5A056.CMP

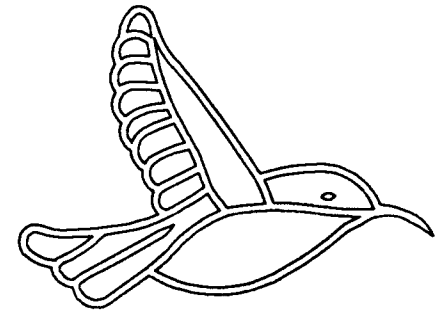

RUST-UNGER MONUMENTS
COLUMBUS IN
STD5A057.CMP

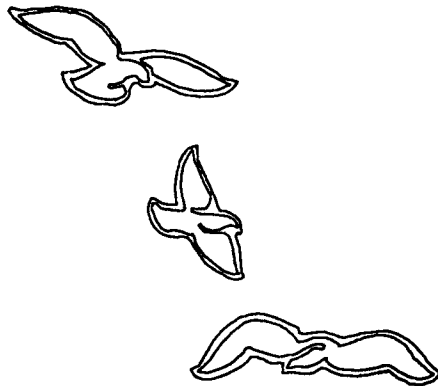

STATEWIDE MEMORIALS
BRUNSWICK ME
STD5A058.CMP

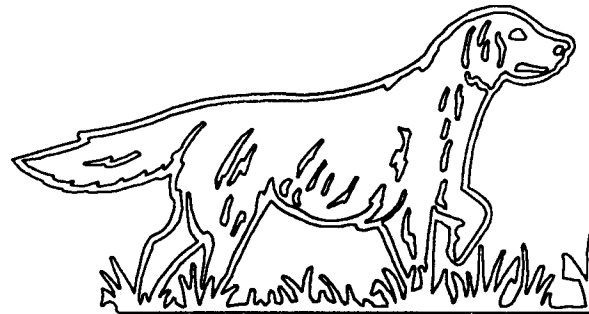

STATEWIDE MEMORIALS
BRUNSWICK ME
STD5A059.CMP

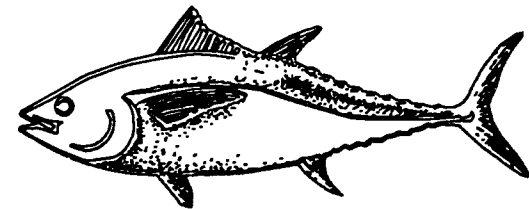

STATEWIDE MEMORIALS
BRUNSWICK ME
STD5A060.CMP



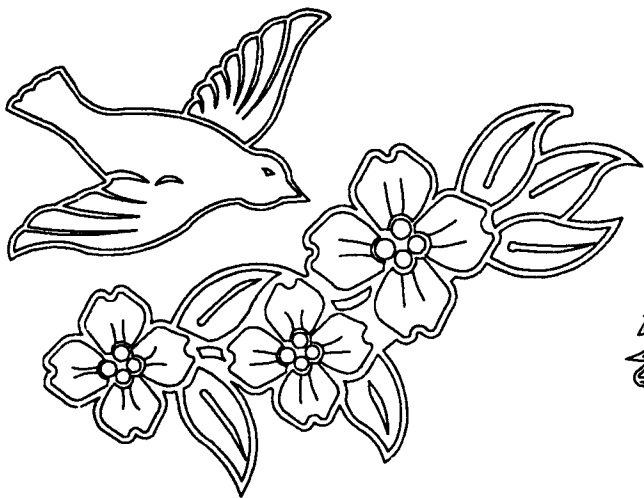

PLETZER MON. DESIGN
BARRE VT STD5A061 .CMP



PALMER MONUMENT CO.
BROKEN BOW NE
STD5A062 .CMP



PALMER MONUMENT CO.
BROKEN BOW NE
STD5A063 .CMP



ELBERTON OFFICE SUPPLY
ELBERTON GA STD5A064 .CMP



ELBERTON OFFICE SUPPLY
ELBERTON GA STD5A065 .CMP



ELBERTON OFFICE SUPPLY
ELBERTON GA STD5A066 .CMP



ELBERTON OFFICE SUPPLY
ELBERTON GA

STD5A067.CMP

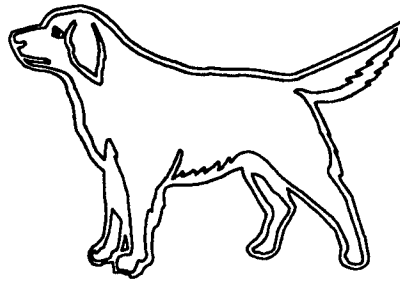

ELBERTON OFFICE SUPPLY
ELBERTON GA

STD5A068.CMP

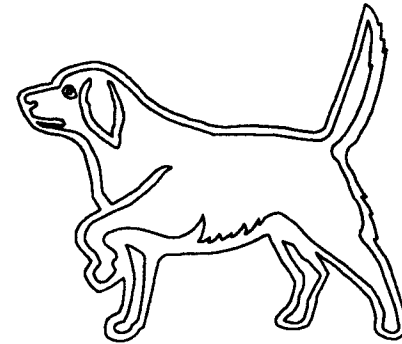

ELBERTON OFFICE SUPPLY
ELBERTON GA

STD5A069.CMP



ELBERTON OFFICE SUPPLY
ELBERTON GA

STD5A070.CMP

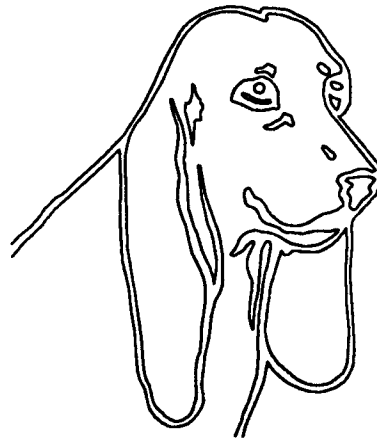

ELBERTON OFFICE SUPPLY
ELBERTON GA

STD5A071.CMP

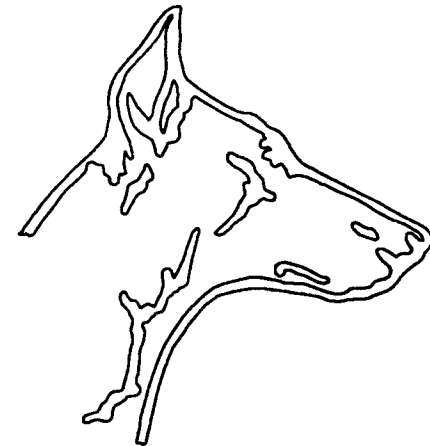

ELBERTON OFFICE SUPPLY
ELBERTON GA

STD5A072.CMP



ELBERTON OFFICE SUPPLY
ELBERTON GA

STD5A073.CMP

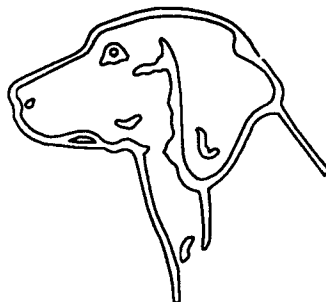

ELBERTON OFFICE SUPPLY
ELBERTON GA

STD5A074.CMP

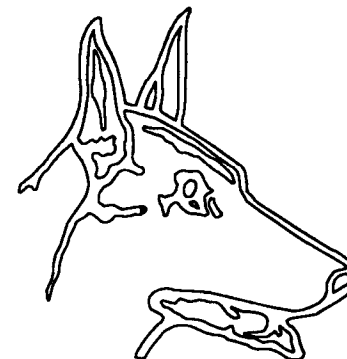

ELBERTON OFFICE SUPPLY
ELBERTON GA

STD5A075.CMP

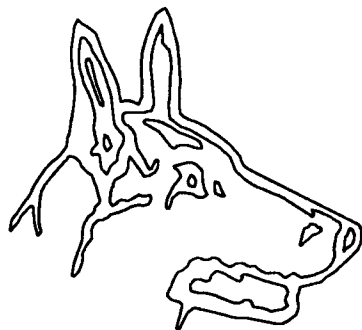

ELBERTON OFFICE SUPPLY
ELBERTON GA

STD5A076.CMP



ELBERTON OFFICE SUPPLY
ELBERTON GA

STD5A077.CMP

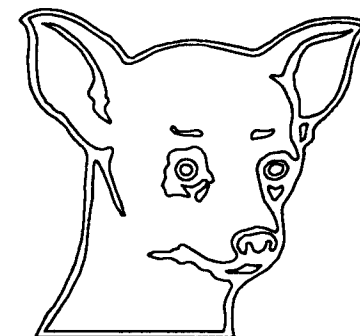

ELBERTON OFFICE SUPPLY
ELBERTON GA

STD5A078.CMP



ELBERTON OFFICE SUPPLY
ELBERTON GA

STD5A079.CMP



ELBERTON OFFICE SUPPLY
ELBERTON GA

STD5A080.CMP

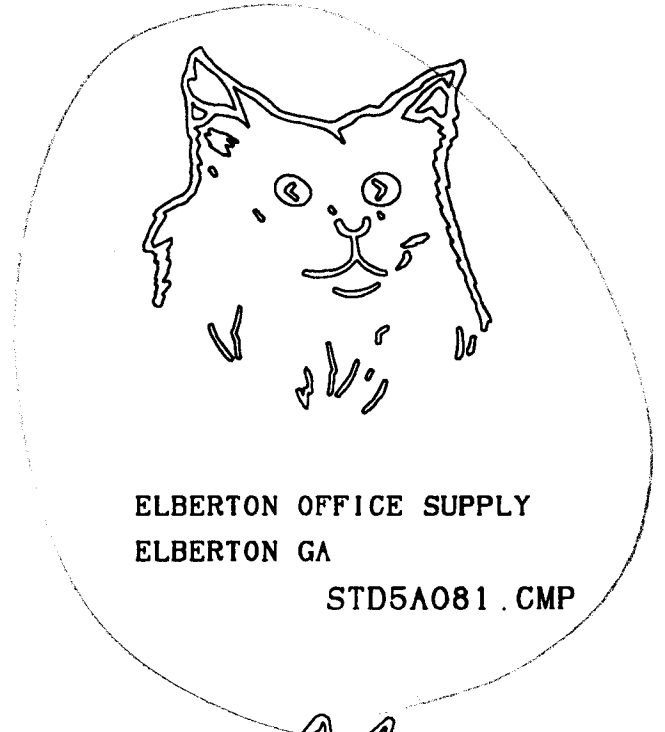

ELBERTON OFFICE SUPPLY
ELBERTON GA

STD5A081.CMP



ELBERTON OFFICE SUPPLY
ELBERTON GA

STD5A082.CMP

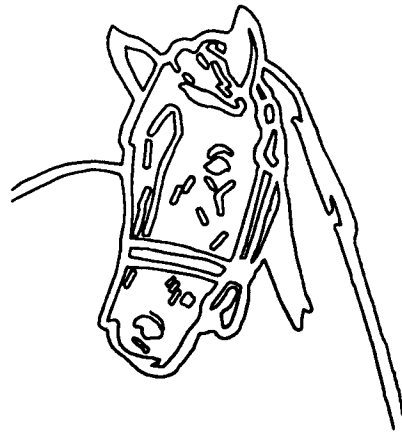

ELBERTON OFFICE SUPPLY
ELBERTON GA

STD5A083.CMP

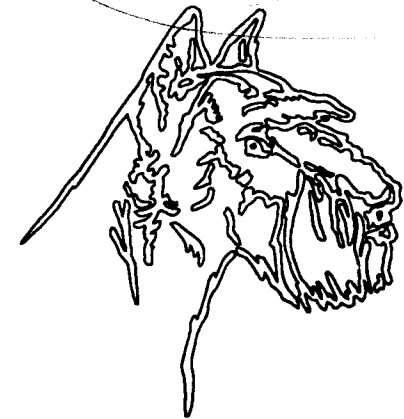

ELBERTON OFFICE SUPPLY
ELBERTON GA

STD5A084.CMP



ELBERTON OFFICE SUPPLY
ELBERTON GA

STD5A085.CMP

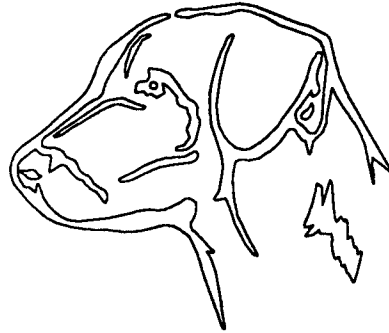

ELBERTON OFFICE SUPPLY
ELBERTON GA

STD5A086.CMP



ELBERTON OFFICE SUPPLY
ELBERTON GA

STD5A087.CMP



ELBERTON OFFICE SUPPLY
ELBERTON GA

STD5A088.CMP



ELBERTON OFFICE SUPPLY
ELBERTON GA

STD5A089.CMP

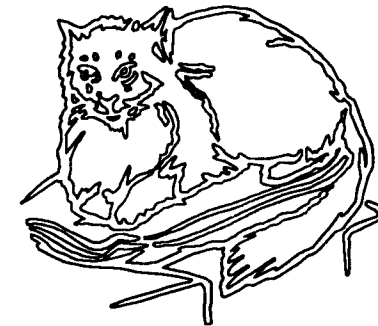

ELBERTON OFFICE SUPPLY
ELBERTON GA

STD5A090.CMP

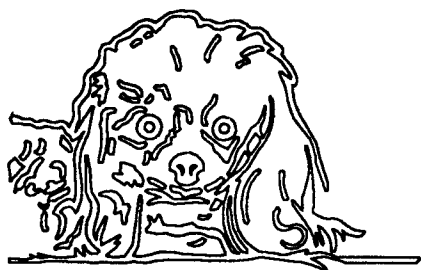

ELBERTON OFFICE SUPPLY
ELBERTON GA

STD5A091 .CMP



ELBERTON OFFICE SUPPLY
ELBERTON GA

STD5A092 .CMP



ELBERTON OFFICE SUPPLY
ELBERTON GA

STD5A093 .CMP

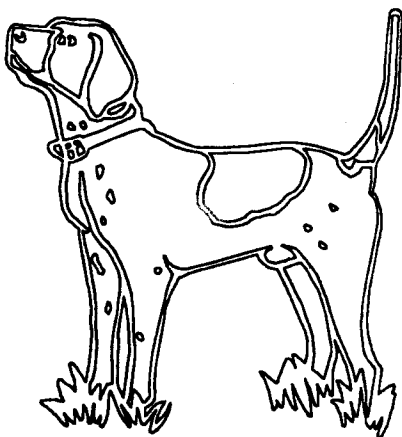

ELBERTON OFFICE SUPPLY
ELBERTON GA

STD5A094 .CMP

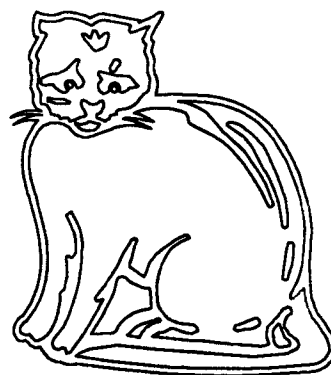

ELBERTON OFFICE SUPPLY
ELBERTON GA

STD5A095 .CMP



ELBERTON OFFICE SUPPLY
ELBERTON GA

STD5A096 .CMP



ELBERTON OFFICE SUPPLY
ELBERTON GA

STD5A097 .CMP



ELBERTON OFFICE SUPPLY
ELBERTON GA

STD5A098 .CMP



ELBERTON OFFICE SUPPLY
ELBERTON GA

STD5A099 .CMF



ELBERTON OFFICE SUPPLY
ELBERTON GA

STD5A100 .CMP

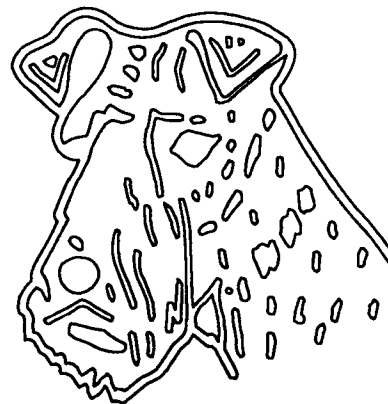

ELBERTON OFFICE SUPPLY
ELBERTON GA

STD5A101 .CMP



ELBERTON OFFICE SUPPLY
ELBERTON GA

STD5A102 .CMP

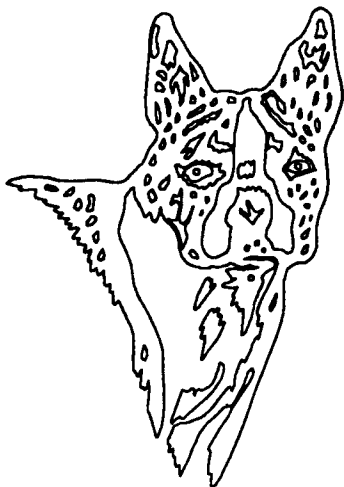

ELBERTON OFFICE SUPPLY
ELBERTON GA

STD5A103.CMP



ELBERTON OFFICE SUPPLY
ELBERTON GA

STD5A104.CMP



ELBERTON OFFICE SUPPLY
ELBERTON GA

STD5A105.CMP



ELBERTON OFFICE SUPPLY
ELBERTON GA

STD5A106.CMP

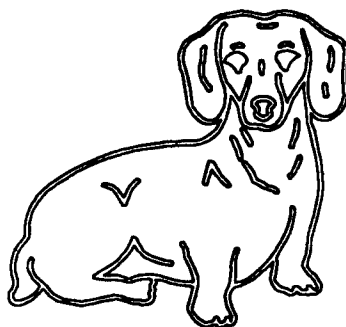

ELBERTON OFFICE SUPPLY
ELBERTON GA

STD5A107.CMP

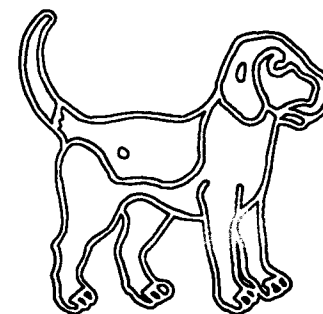

ELBERTON OFFICE SUPPLY
ELBERTON GA

STD5A108.CMP

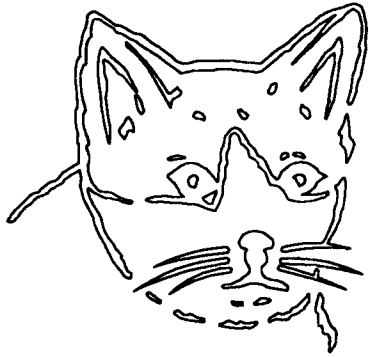

ELBERTON OFFICE SUPPLY
ELBERTON GA

STD5A109.CMP

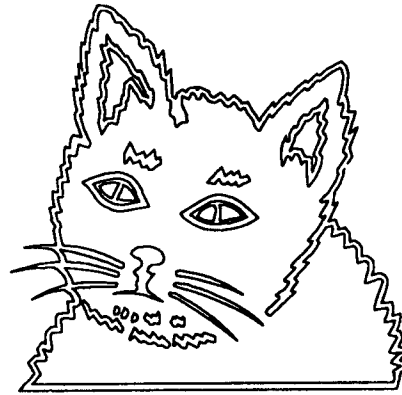

ELBERTON OFFICE SUPPLY
ELBERTON GA

STD5A110.CMP

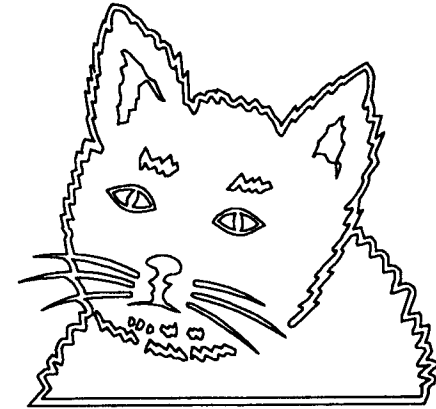

ELBERTON OFFICE SUPPLY
ELBERTON GA

STD5A111.CMP



ELBERTON OFFICE SUPPLY
ELBERTON GA

STD5A112.CMP

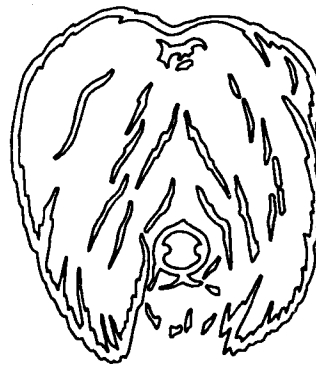

ELBERTON OFFICE SUPPLY
ELBERTON GA

STD5A113.CMP



ELBERTON OFFICE SUPPLY
ELBERTON GA

STD5A114.CMP



ELBERTON OFFICE SUPPLY
ELBERTON GA

STD5A115.CMP



ELBERTON OFFICE SUPPLY
ELBERTON GA

STD5A116.CMP

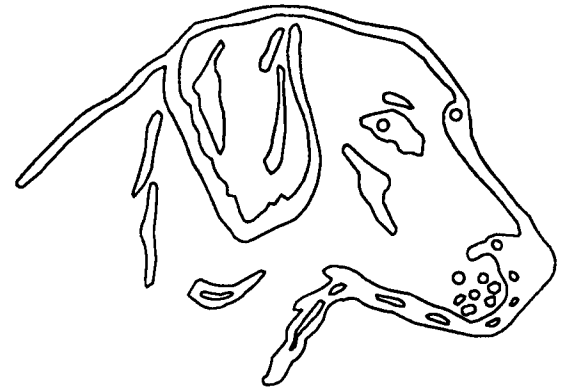

ELBERTON OFFICE SUPPLY
ELBERTON GA

STD5A117.CMP

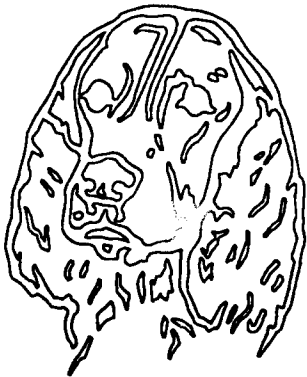

ELBERTON OFFICE SUPPLY
ELBERTON GA

STD5A118.CMP



ELBERTON OFFICE SUPPLY
ELBERTON GA

STD5A119.CMP



ELBERTON OFFICE SUPPLY
ELBERTON GA

STD5A120.CMP



ELBERTON OFFICE SUPPLY
ELBERTON GA
STD5121.CMP

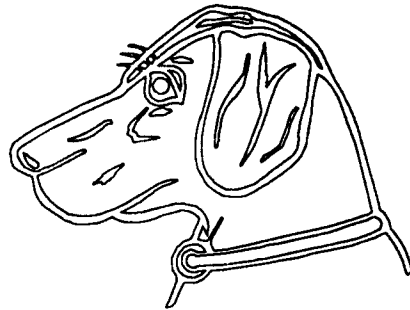

ELBERTON OFFICE SUPPLY
ELBERTON GA
STD5122.CMP

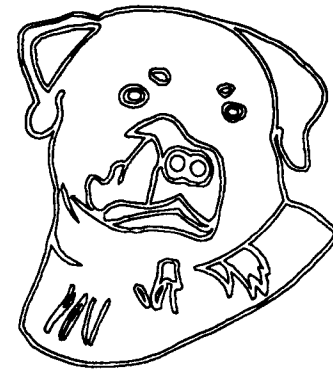

ELBERTON OFFICE SUPPLY
ELBERTON GA
STD5123.CMP

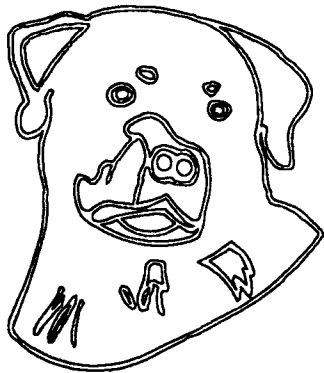

ELBERTON OFFICE SUPPLY
ELBERTON GA
STD5A124.CMP



ELBERTON OFFICE SUPPLY
ELBERTON GA
STD5A125.CMP

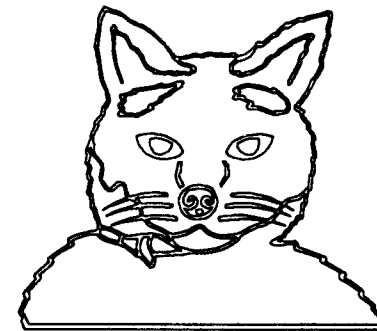

ELBERTON OFFICE SUPPLY
ELBERTON GA
STD5A126.CMP

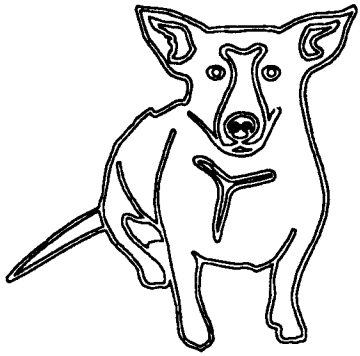

ELBERTON OFFICE SUPPLY
ELBERTON GA

STD5A127.CMP

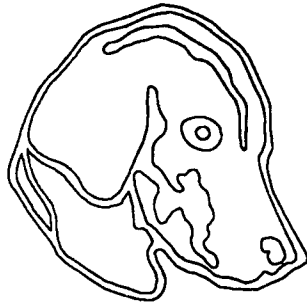

ELBERTON OFFICE SUPPLY
ELBERTON GA

STD5A128.CMP

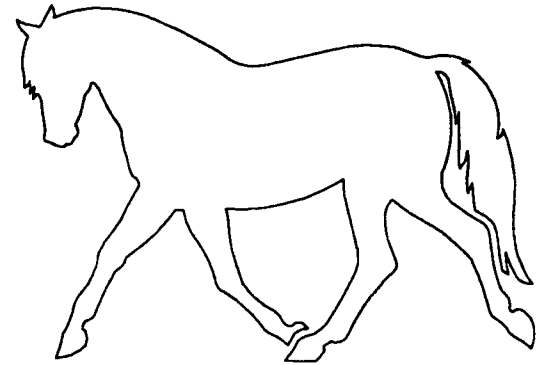

ELBERTON OFFICE SUPPLY
ELBERTON GA

STD5A129.CMP

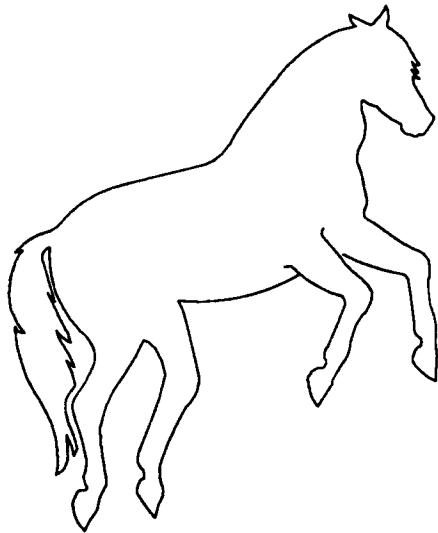

ELBERTON OFFICE SUPPLY
ELBERTON GA

STD5A130.CMP



ELBERTON OFFICE SUPPLY
ELBERTON GA

STD5A131.CMP



MILLER BROS. MONUMENTS
IOWA CITY IA

STD5A132.CMP

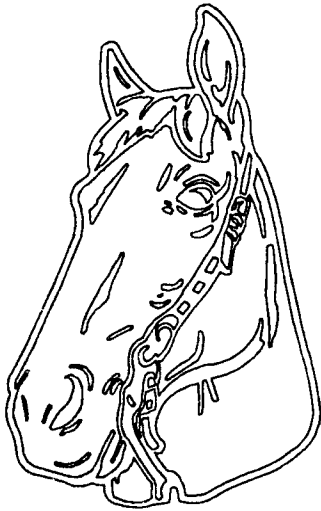

MILLER BROS. MONUMENT
IOWA CITY IA
STD5A133.CMP



MILLER BROS. MONUMENT
IOWA CITY IA
STD5A134.CMP

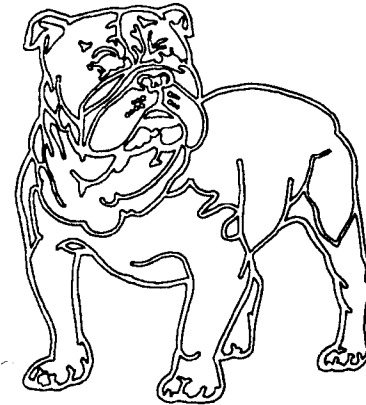

ST. CHARLES MEMORIAL WORKS
ST. CHARLES IL
STD5A135.CMP

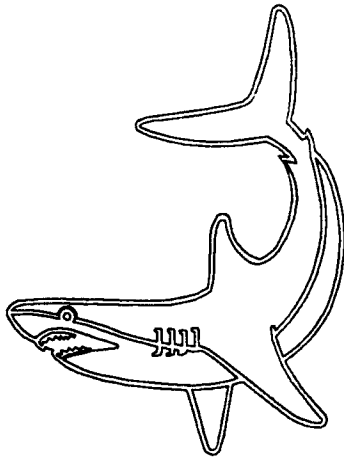

ST. CHARLES MEMORIAL WORKS
ST. CHARLES IL
STD5A136.CMP

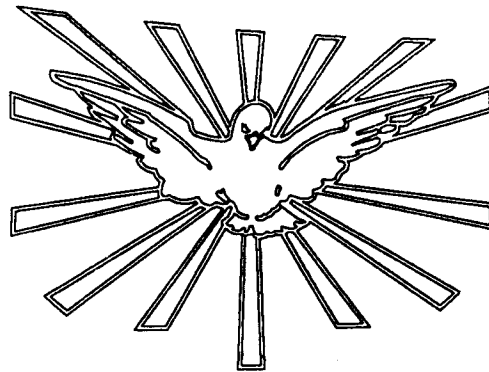

ST. CHARLES MEMORIAL WORKS
ST. CHARLES IL
STD5A137.CMP



ST. CHARLES MEMORIAL WORKS
ST. CHARLES IL
STD5A138.CMP

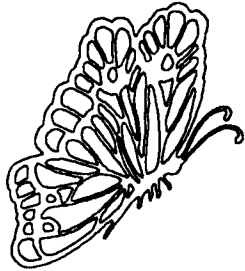

ROLLA MONUMENT CO.
ROLLA MO

STD5A139.CMP

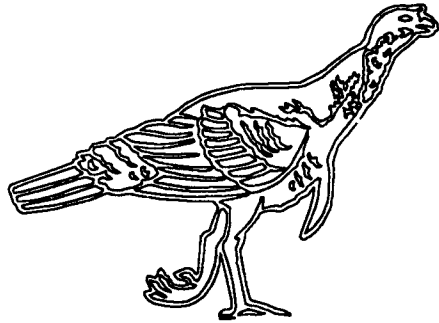

ROLLA MONUMENT CO.
ROLLA MO

STD5A140.CMP



ROLLA MONUMENT CO.
ROLLA MO

STD5A141.CMP



ROLLA MONUMENT CO.
ROLLA MO

STD5A142.CMP



ROLLA MONUMENT CO.
ROLLA MO

STD5A143.CMP

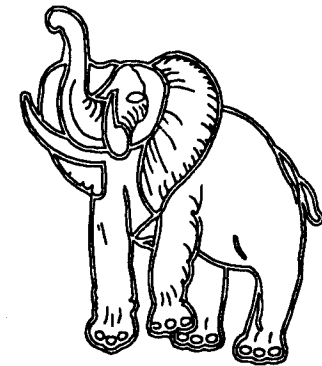

ADVANCED MEMORIAL DESIGN
MORRISTOWN TN

STD5A144.CMP

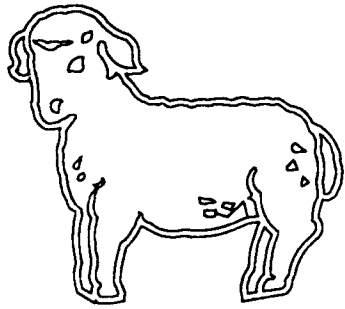

ADVANCED MEMORIAL DESIGN
MORRISTOWN TN

STD5A145.CMP

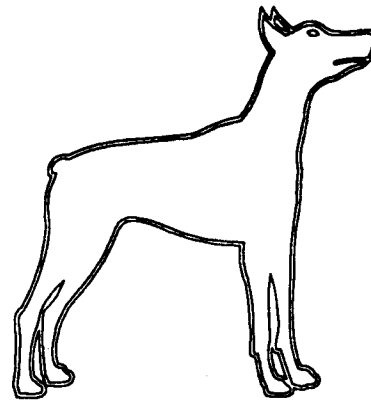

ADVANCED MEMORIAL DESIGN
MORRISTOWN TN

STD5A146.CMP

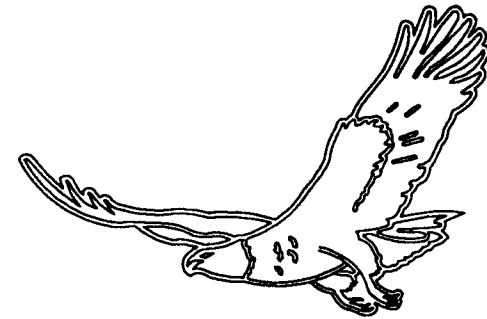

ADVANCED MEMORIAL DESIGN
MORRISTOWN TN

STD5A147.CMP

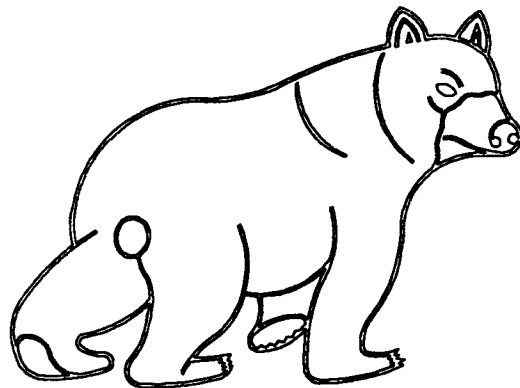

ADVANCED MEMORIAL DESIGN
MORRISTOWN TN

STD5A148.CMP

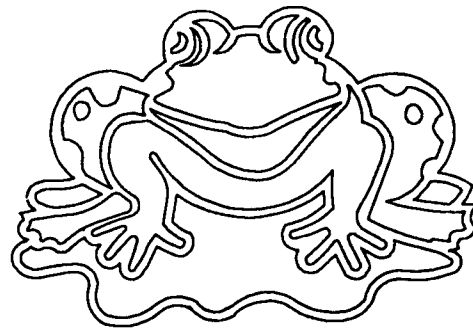

MILACEK MONUMENT CO.
OMAHA NE

STD5A149.CMP



MILLIGAN MEMORIALS
COSHOCOTON OH

STD5A150.CMP

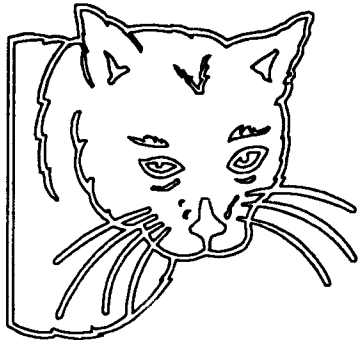

QUALITY-CUT MONUMENTAL DESIGNS
ELBERTON GA

STD5A151.CMP

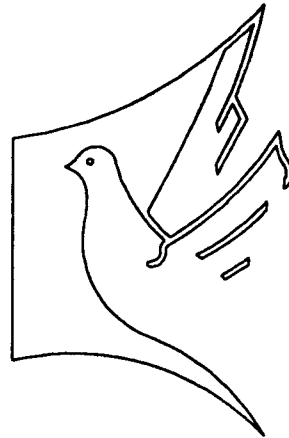

SEBASTIANO AIELLO MONUMENTS INC
MONTREAL QUEBEC CANADA

STD5A152.CMP



SEBASTIANO AIELLO MONUMENTS INC
MONTREAL QUEBEC CANADA

STD5A153.CMP

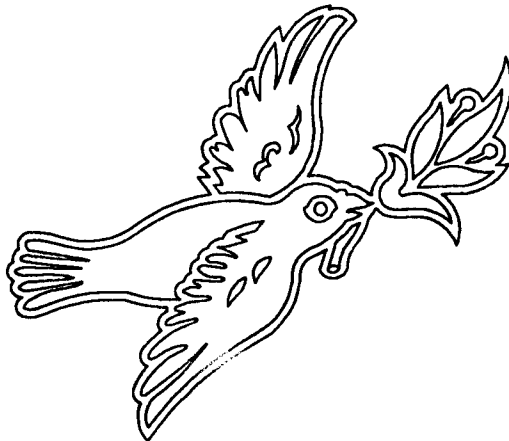

SEBASTIANO AIELLO MONUMENTS INC
MONTREAL QUEBEC CANADA

STD5A154.CMP

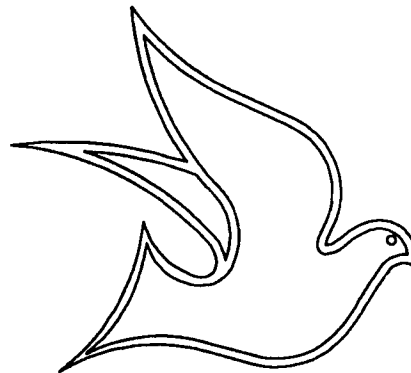

SEBASTIANO AIELLO MONUMENTS INC
MONTREAL QUEBEC CANADA

STD5A155.CMP

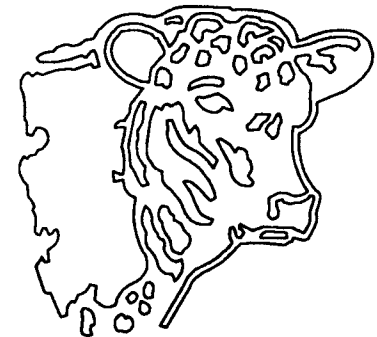

BOYCE MONUMENTAL SALES LTD
CARROLL IA

STD5A156.CMP





BOYCE MONUMENTAL SALES LTD
CARROLL IA

STD5A157.CMP

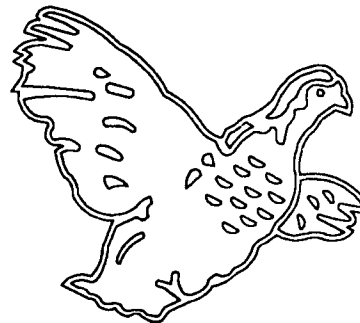

BOYCE MONUMENTAL SALES LTD
CARROLL IA

STD5A158.CMP



BAY MONUMENT CO
BAY CITY MI

STD5A159.CMP



BAY MONUMENT CO
BAY CITY MI

STD5A160.CMP



BAY MONUMENT CO
BAY CITY MI

STD5A161.CMP



BAY MONUMENT CO
BAY CITY MI

STD5A162.CMP

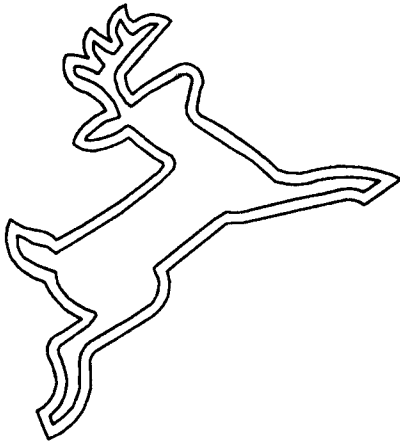

LONGSTRETH MEMORIALS
GALION OH

STD5A163.CMP

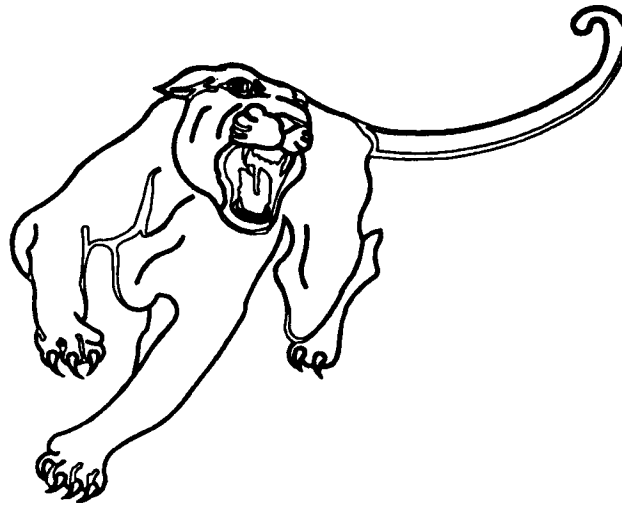

J. W. REYNOLDS MONUMENTS
VIENNA IL

STD5A164.CMP

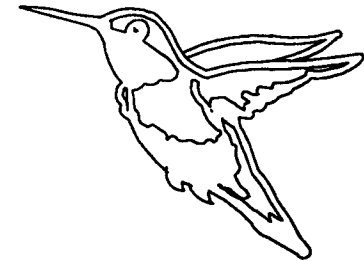

CROWN MONUMENT
WARREN OH

STD5A165.CMP

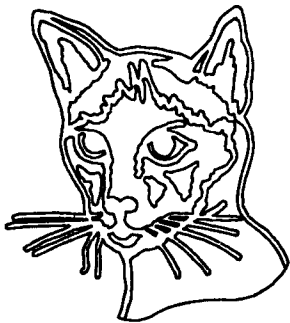

W.P. SIMMONS. INC
MT. AIRY NC

STD5A166.CMP

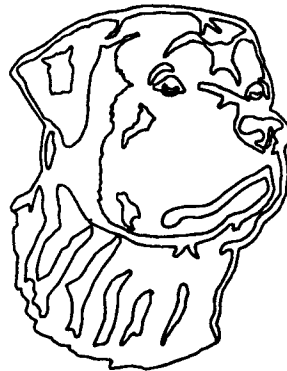

W.P. SIMMONS. INC
MT. AIRY NC

STD5A167.CMP



W.P. SIMMONS. INC
MT. AIRY NC

STD5A168.CMP



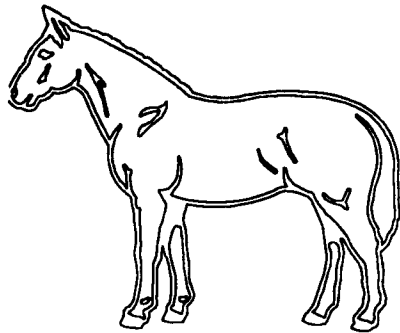

W.P. SIMMONS INC
MT. AIRY NC

STD5A169.CMP

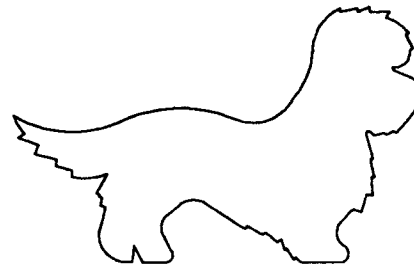

SMYTH MEMORIAL CO
CHATHAM ONTARIO CANADA

STD5A170.CMP

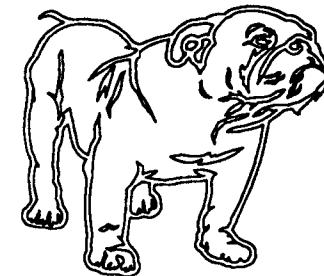

SMYTH MEMORIAL CO
CHATHAM ONTARIO CANADA

STD5A171.CMP

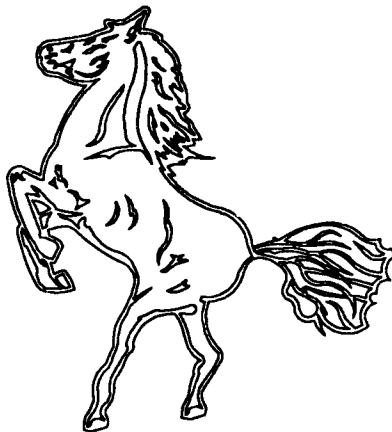

SMYTH MEMORIAL CO
CHATHAM ONTARIO CANADA

STD5A172.CMP



SMYTH MEMORIAL CO
CHATHAM ONTARIO CANADA

STD5A173.CMP



MILWAUKEE MEMORIAL CO
MILWAUKEE WI

STD5A174.CMP

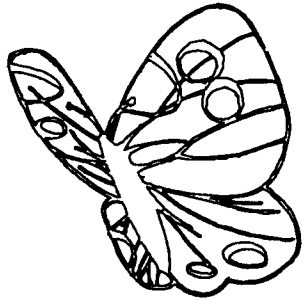

MILWAUKEE MEMORIAL CO
MILWAUKEE WI

STD5A175.CMP



MILWAUKEE MEMORIAL CO
MILWAUKEE WI

STD5A176.CMP

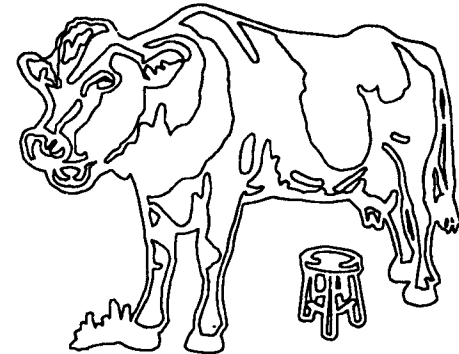

MILWAUKEE MEMORIAL CO
MILWAUKEE WI

STD5A177.CMP

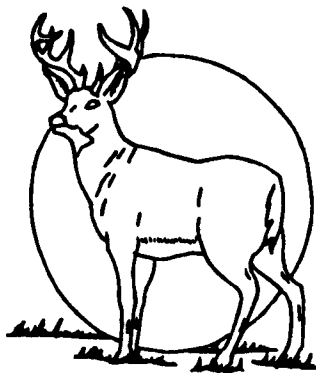

HUTCH CUSTOM DESIGN
GROVETON NH

STD5A178.CMP



HUTCH CUSTOM DESIGN
GROVETON NH

STD5A179.CMP

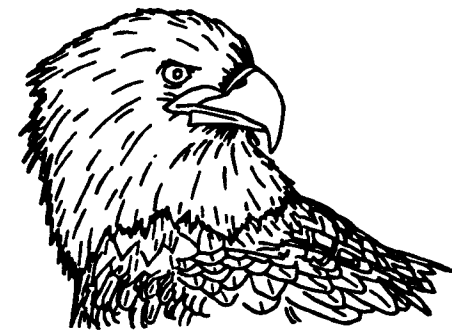

HUTCH CUSTOM DESIGN
GROVETON NH

STD5A180.CMP

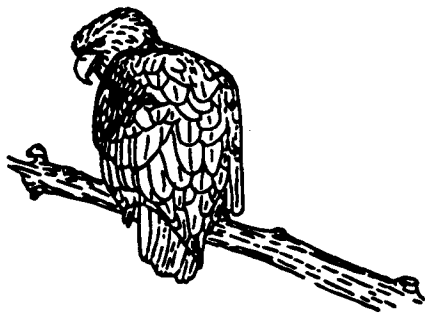

HUTCH CUSTOM DESIGN
GROVETON NH

STD5A181.CMP

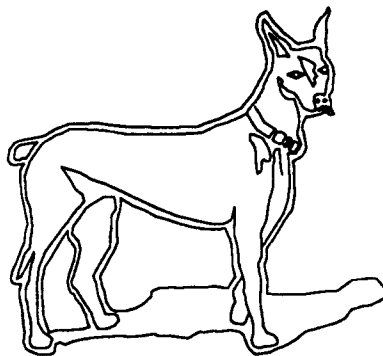

MOORE MONUMENT CO
CHILLICOTHE MO

STD5A182.CMP

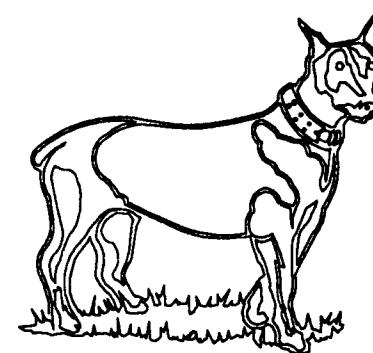

MOORE MONUMENT CO
CHILLICOTHE MO

STD5A183.CMP

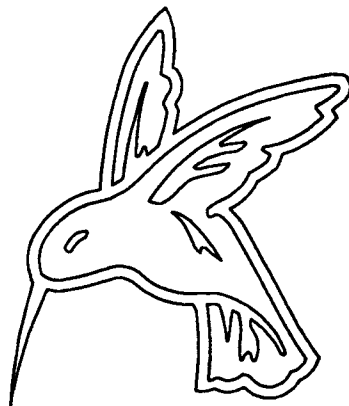

MOORE MONUMENT CO
CHILLICOTHE MO

STD5A184.CMP

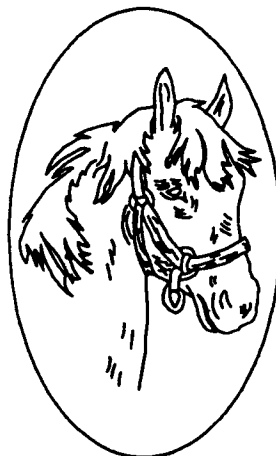

MOORE MONUMENT CO
CHILLICOTHE MO

STD5A185.CMP

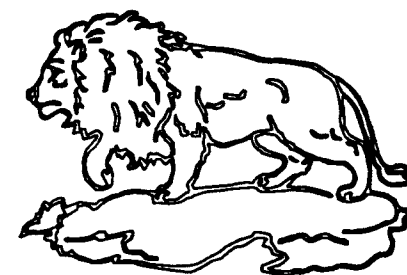

MOORE MONUMENT CO
CHILLICOTHE MO

STD5A186.CMP

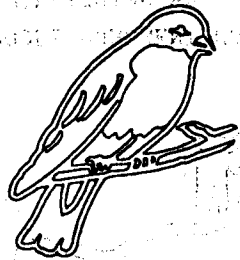

PEORIA MONUMENT CO
PEORIA IL

STD5A187.CMP

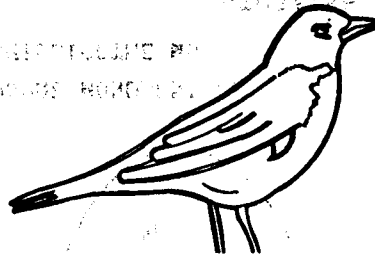

PEORIA MONUMENT CO
PEORIA IL

STD5A188.CMP

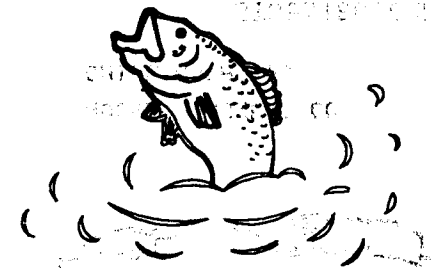

PEORIA MONUMENT CO
PEORIA IL

STD5A189.CMP



JAMESTOWN MONUMENT
JAMESTOWN ND

STD5A190.CMP

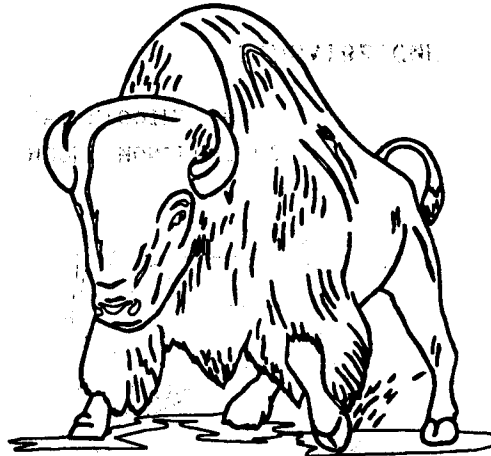

JAMESTOWN MONUMENT
JAMESTOWN ND

STD5A191.CMP



JAMESTOWN MONUMENT
JAMESTOWN ND

STD5A192.CMP

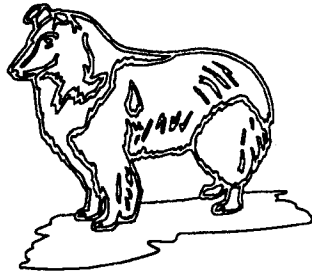

JAMESTOWN MONUMENT
JAMESTOWN ND

STD5A193.CMP



HAMILTON MEMORIALS
HAMILTON ONTARIO CANADA

STD5A194.CMP



McGARRY MEMORIALS
CHORLTON MANCHESTER UK

STD5A195.CMP

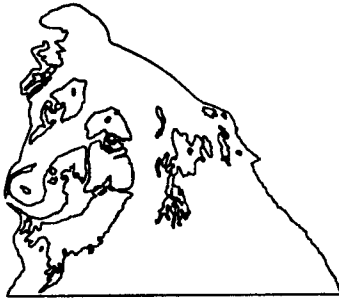

McGARRY MEMORIALS
CHORLTON MANCHESTER UK

STD5A196.CMP



BEESELY MONUMENT CO
PROVO UT

STD5A197.CMP

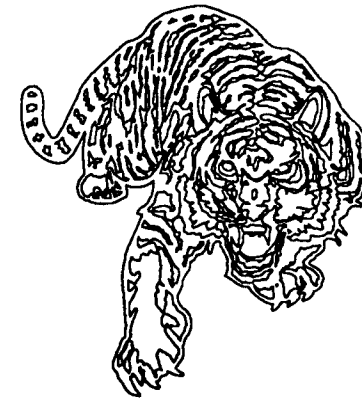

BEESELY MONUMENT CO
PROVO UT

STD5A198.CMP

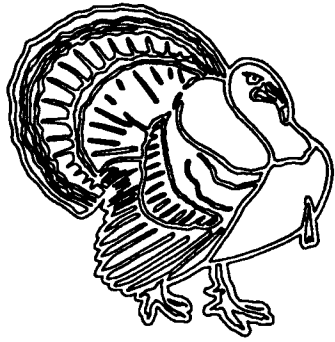

BEESLEY MONUMENT CO
PROVO UT

STD5A199.CMP



KIRKPATRICK & O'BRINE LTD
FONTHILL ONTARIO CANADA

STD5A200.CMP

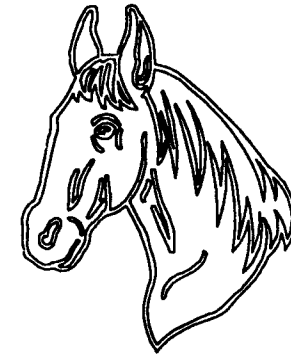

LEXINGTON GRANITE CO
LEXINGTON KY

STD5A201.CMP



LEXINGTON GRANITE CO
LEXINGTON KY

STD5A202.CMP

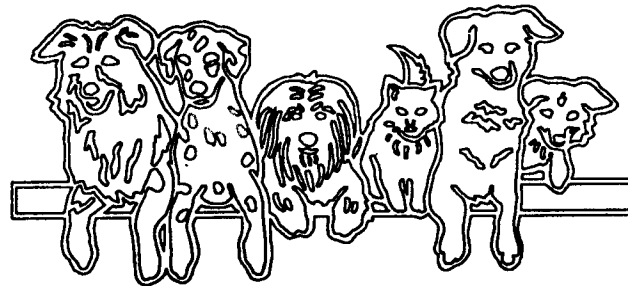

LEXINGTON GRANITE CO
LEXINGTON KY

STD5A203.CMP



LEXINGTON GRANITE CO
LEXINGTON KY

STD5A204.CMP

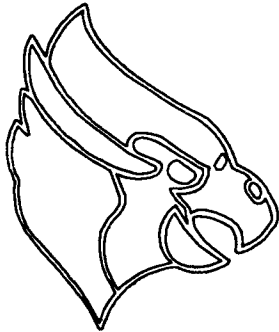

LEXINGTON GRANITE CO
LEXINGTON KY

STD5A205.CMP

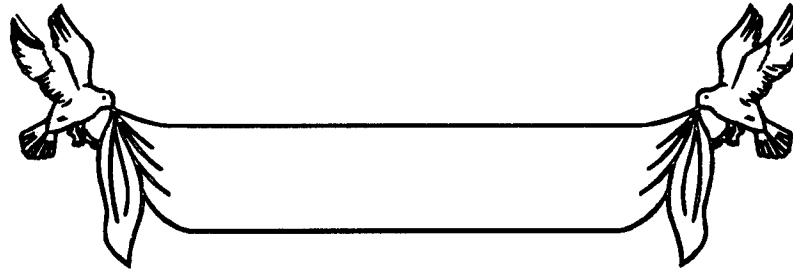

LEXINGTON GRANITE CO
LEXINGTON KY

STD5A206.CMP

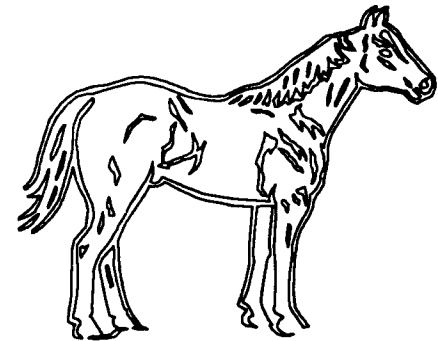

BROWN MONUMENT
LOGAN UT

STD5A207.CMP

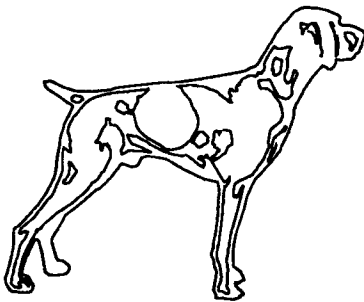

BROWN MONUMENT
LOGAN UT

STD5A208.CMP

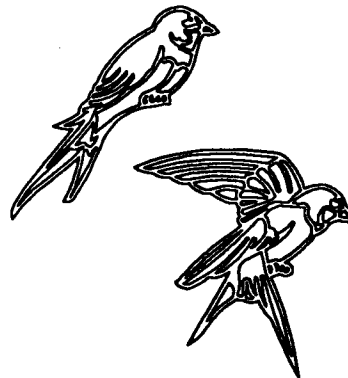

GRANITE APPALACHES
LAC DROLET QUEBEC CANADA

STD5A209.CMP



GRANITE APPALACHES
LAC DROLET QUEBEC CANADA

STD5A210.CMP

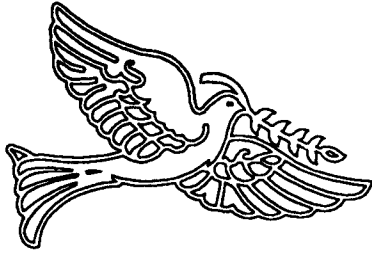

GRANITE APPALACHES
LAG DROLET QUEBEC CANADA

STD5A211.CMP

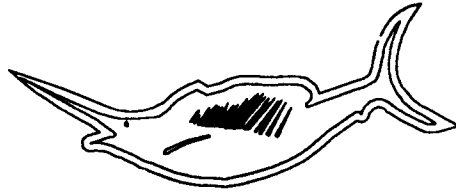

FOREST PARK MEMORIALS
HOUSTON TX

STD5A212.CMP

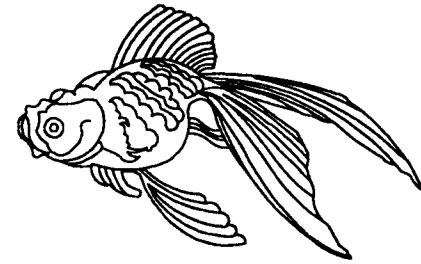

SCHAEFER MONUMENT CO
ST. LOUIS MO

STD5A213.CMP



SCHAEFER MONUMENT CO
ST. LOUIS MO

STD5A214.CMP

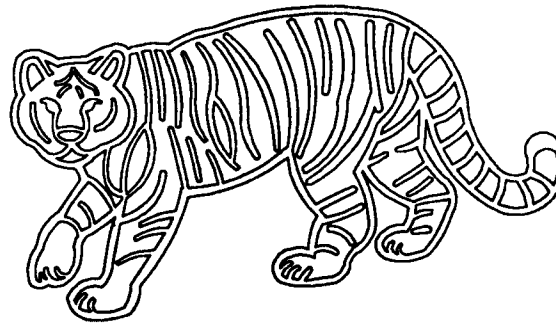

SCHAEFER MONUMENT CO
ST. LOUIS MO

STD5A215.CMP



TROY MARBLE & GRANITE WORKS
TROY PA

STD5A216.CMP



TROY MARBLE & GRANITE WORKS
TROY PA

STD5A217.CMP

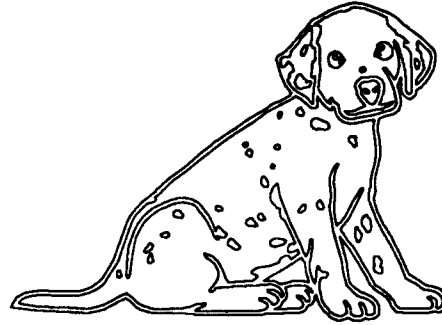

TROY MARBLE & GRANITE WORKS
TROY PA

STD5A218.CMP

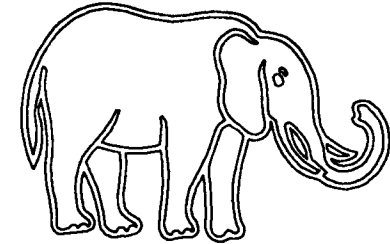

TROY MARBLE & GRANITE WORKS
TROY PA

STD5A219.CMP



L.J. SERVICES
CHERRY VALLEY NY

STD5A220.CMP

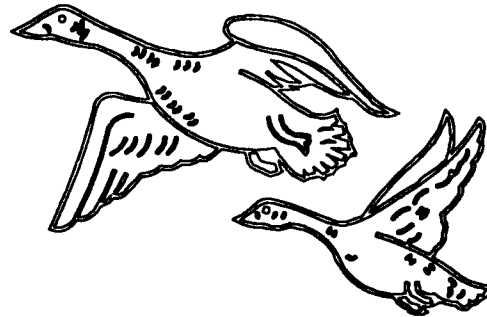

L.J. SERVICES
CHERRY VALLEY NY

STD5A221.CMP

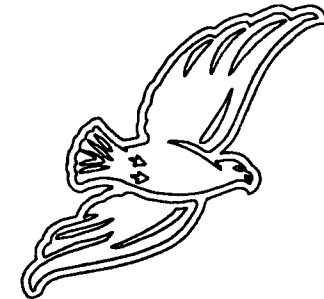

VISALIA GRANITE & MARBLE WORKS
VISALIA CA

STD5A222.CMP

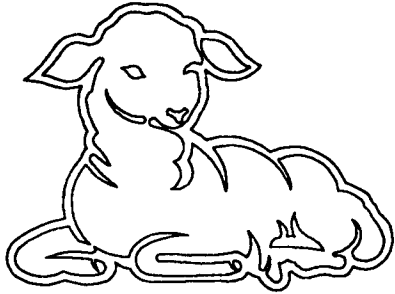

VISALIA GRANITE & MARBLE WORKS
VISALIA CA

STD5A223.CMP



WEARLY MONUMENTS
MUNCIE IN

STD5A224.CMP



LANDMARK GRANITE CO
ELBERTON GA

STD5A225.CMP



LANDMARK GRANITE CO
ELBERTON GA

STD5A226.CMP

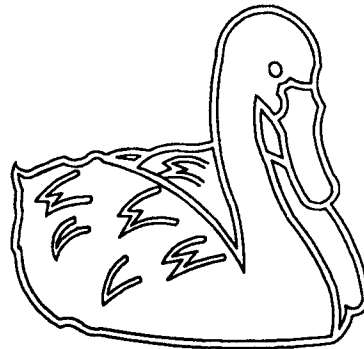

RINKER & FRYE MEMORIALS
MT. JACKSON VA

STD5A227.CMP



RINKER & FRYE MEMORIALS
MT. JACKSON VA

STD5A228.CMP

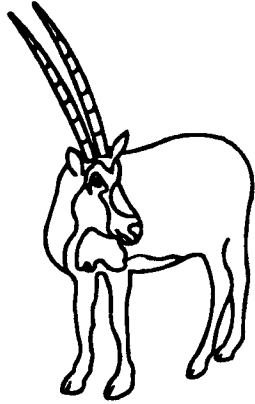

RINKER & FRYE MEMORIALS
MT. JACKSON VA

STD5A229.CMP

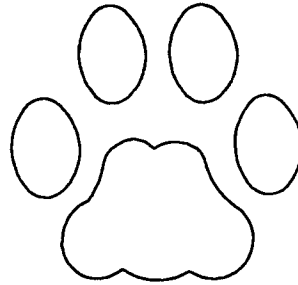

GRIMES BROS. GRANITE CO
ELBERTON GA

STD5A230.CMP

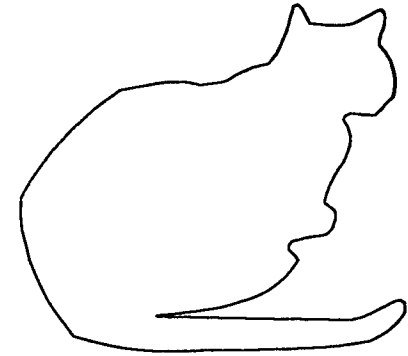

GRIMES BROS. GRANITE CO
ELBERTON GA

STD5A231.CMP



GRIMES BROS. GRANITE CO
ELBERTON GA

STD5A232.CMP



BRACOLONI CUSTOM MEMORIALS
TRENTON NJ

STD5A233.CMP

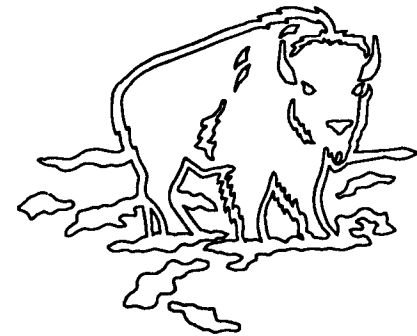

ART STONE CO
ROCK ISLAND IL

STD5A234.CMP



ART STONE CO
ROCK ISLAND IL

STD5A235.CMP

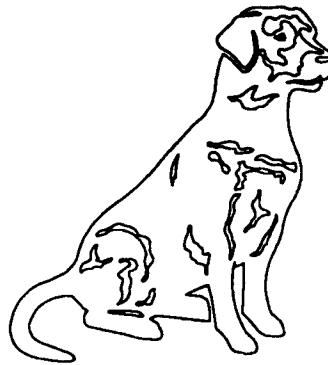

ART STONE CO
ROCK ISLAND IL

STD5A236.CMP



ART STONE CO
ROCK ISLAND IL

STD5A237.CMP

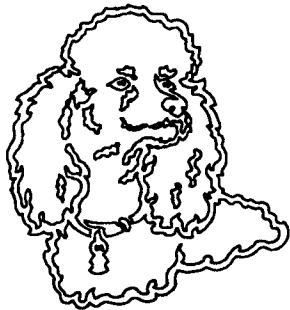

ART STONE CO
ROCK ISLAND IL

STD5A238.CMP



ART STONE CO
ROCK ISLAND IL

STD5A239.CMP



ART STONE CO
ROCK ISLAND IL

STD5A240.CMP



ART STONE CO
ROCK ISLAND IL

STD5A241 .CMP

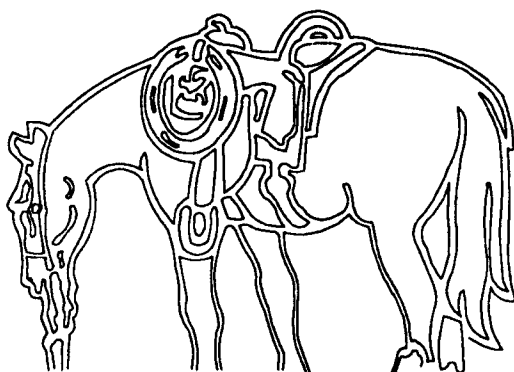

NICHOLSON MONUMENT CO
CLINTON OK

STD5A242 .CMP

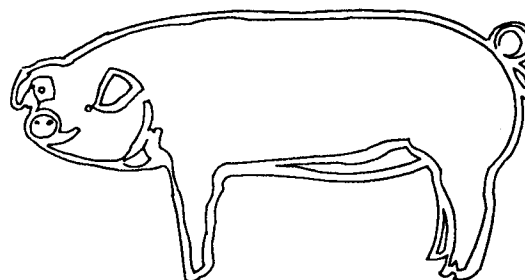

NICHOLSON MONUMENT CO
CLINTON OK

STD5A243 .CMP

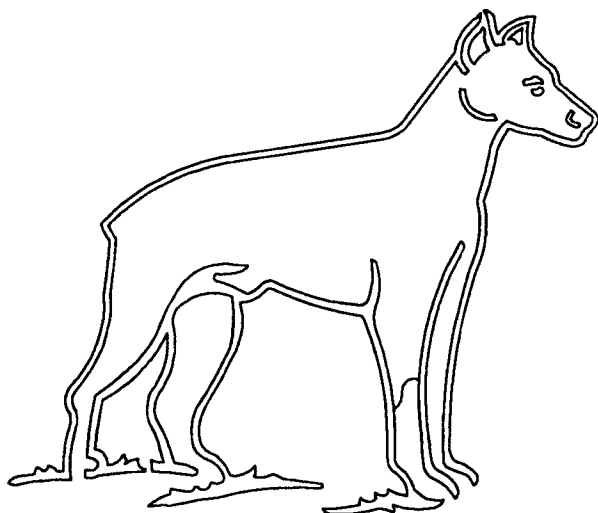

CARON GRANITE CO
PAWTUCKET RI

STD5A244 .CMP

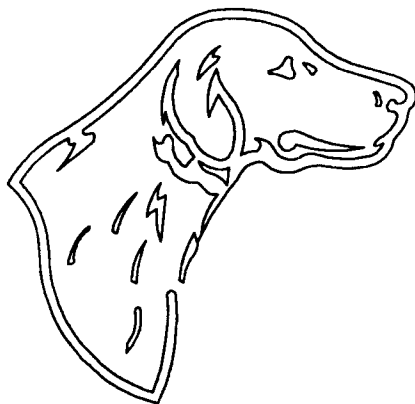

CARON GRANITE CO
PAWTUCKET RI

STD5A245 .CMP

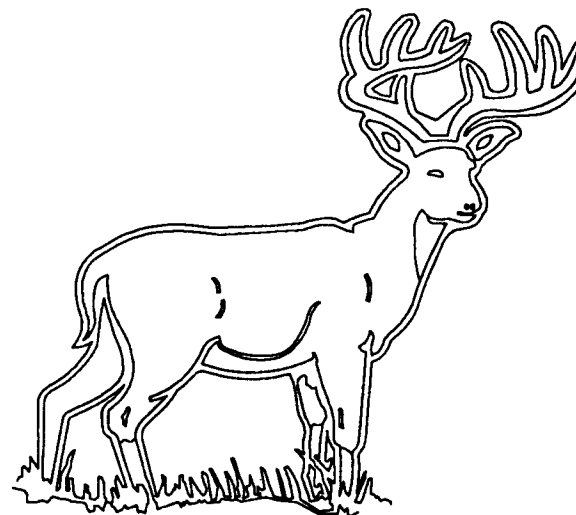

PLOUFF S MONUMENT CO
ST. ALBANS VT

STD5A246 .CMP



OREGON GRANITE CO
MEDFORD OR

STD5A247.CMP

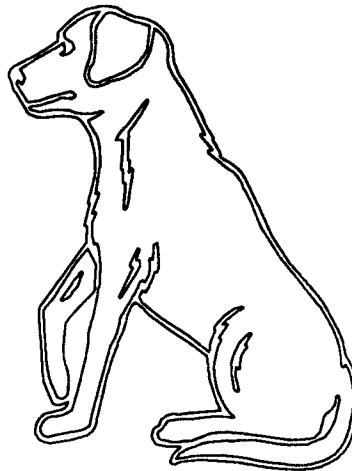

OREGON GRANITE CO
MEDFORD OR

STD5A248.CMP

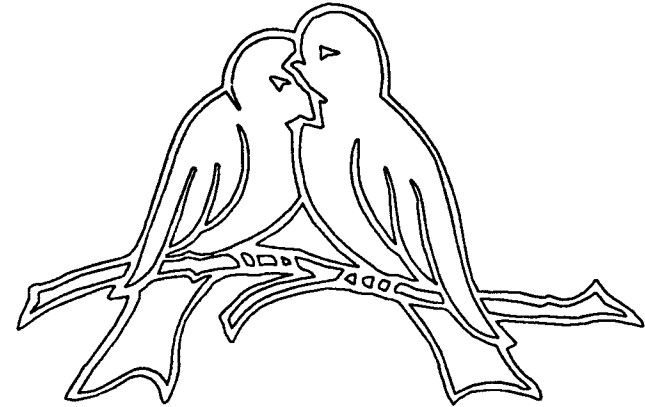

OREGON GRANITE CO
MEDFORD OR

STD5A249.CMP

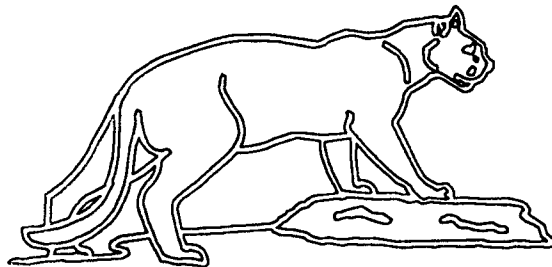

OREGON GRANITE CO
MEDFORD OR

STD5A250.CMP



PHOENIXVILLE MEMORIAL WORKS
PHOENIXVILLE PA

STD5A251.CMP



PHOENIXVILLE MEMORIAL WORKS
PHOENIXVILLE PA

STD5A252.CMP

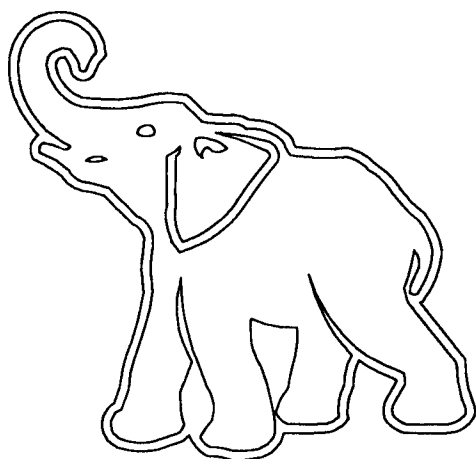

PEEBLES MONUMENT CO
PEEBLES OH

STD5A253.CMP

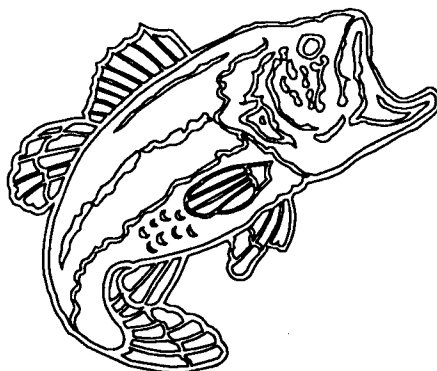

CHERRY VALLEY MEMORIALS
CHERRY VALLEY NY

STD5A254.CMP



CHERRY VALLEY MEMORIALS
CHERRY VALLEY NY

STD5A255.CMP

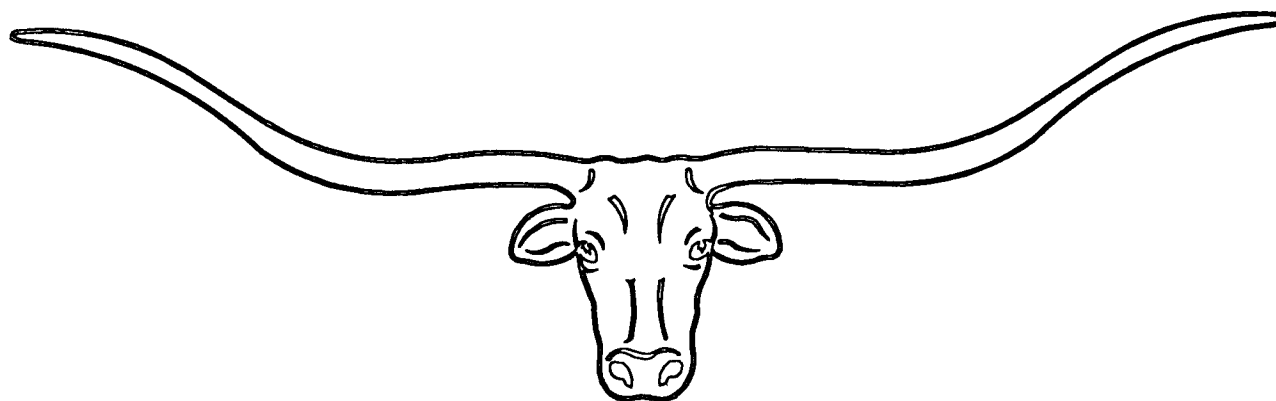

WEARLY MONUMENTS
MUNCIE IN

STD5A256.CMP





STAFFORD MONUMENTS
WHITBY ONTARIO STD5C001.CMP

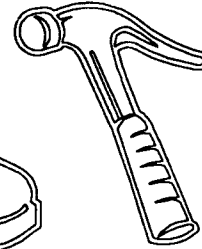

SANDZIMIER MEMORIALS
SCOTTDALE PA STD5C002.CMP

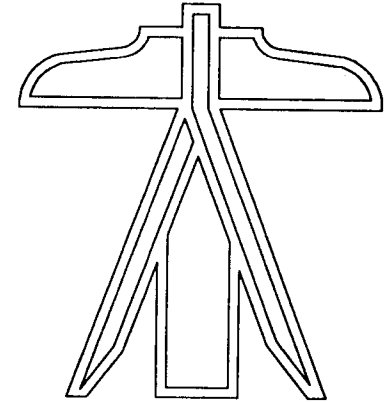

PIQUA GRANITE & MARBLE
PIQUA OH STD5C003.CMP

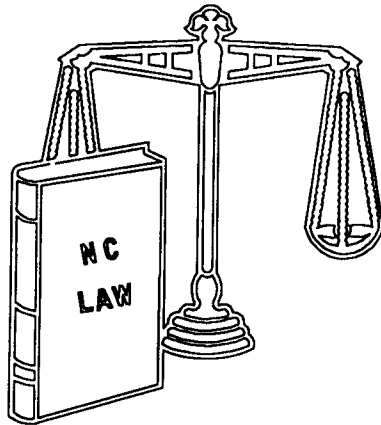

N.C. MARBLE & GRANITE
CLINTON NC STD5C004.CMP



GRANITE LACROIX
VIMONT-LAVAL QUEBEC
STD5C005.CMP



GRANITE LACROIX
VIMONT-LAVAL QUEBEC
STD5C006.CMP

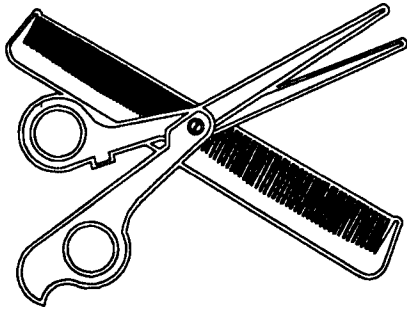

GALLAGHER MONUMENTS
MALAGA OH

STD5C007.CMP

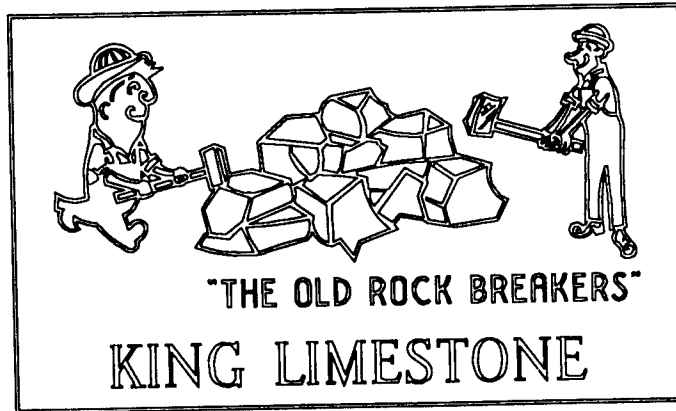

GALLAGHER MONUMENTS
MALAGA OH

STD5C008.CMP

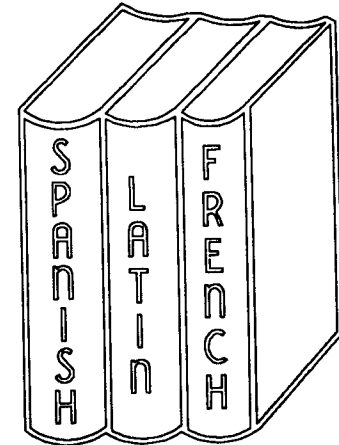

ERIE CITY MEMORIALS

ERIE PA STD5C009.CMP

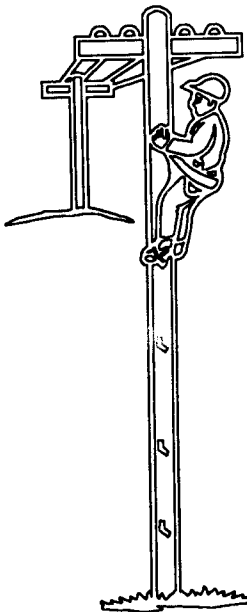

WOODWARD MONUMENT

VICI OK

STD5C010.CMP

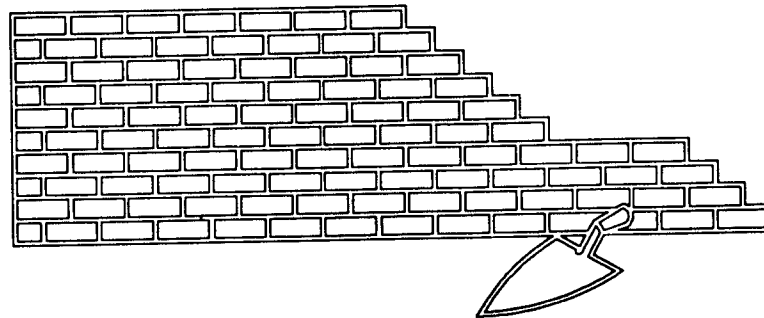

WOODWARD MONUMENT

VICI OK

STD5C011.CMP

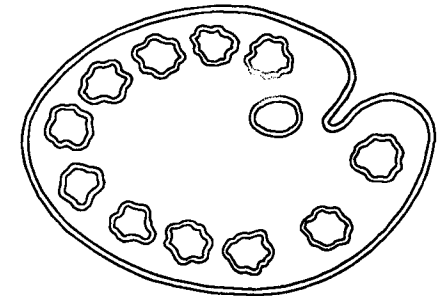

RUST-UNGER MONUMENTS

COLUMBUS IN

STD5C012.CMP

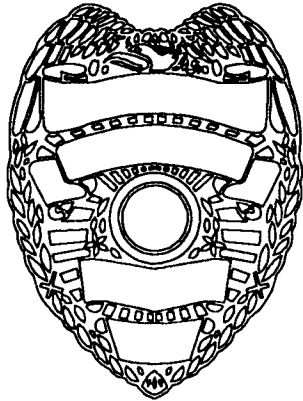

RUST-UNGER MONUMENTS
COLUMBUS IN
STD5C013.CMP

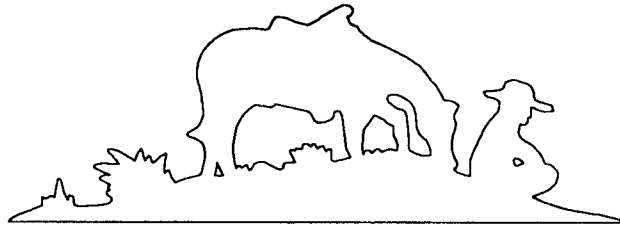

SEAMON-POE MONUMENT CO.
SAN DIEGO CA
STD5C014.CMP

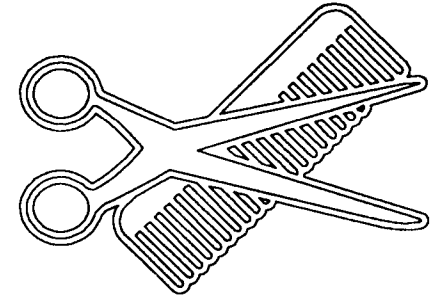

MILLER BROS. MONUMENT
IOWA CITY IA
STD5C015.CMP

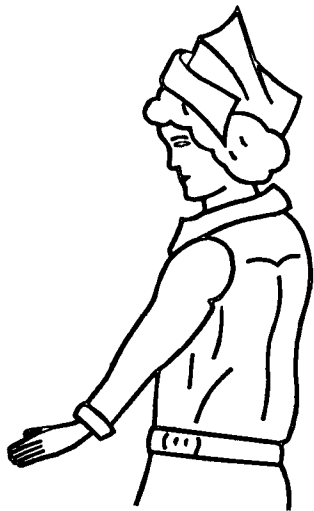

ADVANCED MEMORIAL DESIGN
MORRISTOWN TN
STD5C016.CMP

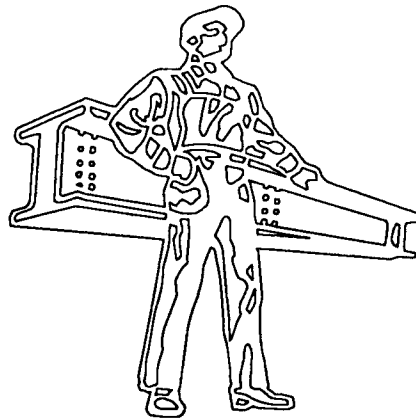

MILLIGAN MEMORIALS
COSHOCKTON OH

STD5C017.CMP



BOYCE MONUMENTAL SALES LTD
CARROLL IA

STD5C018.CMP

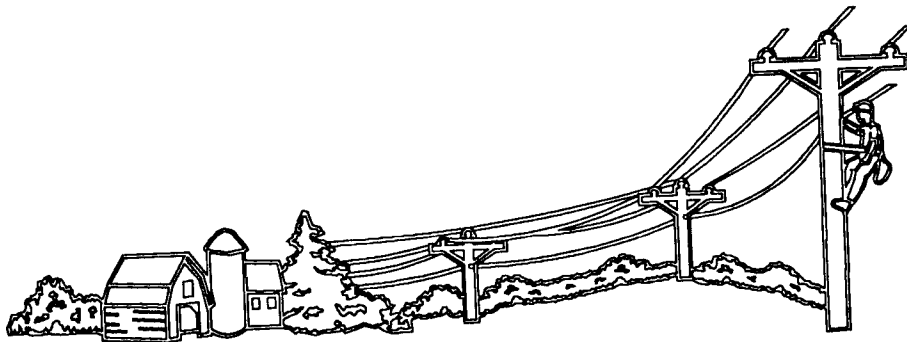

BOYCE MONUMENTAL SALES LTD
CARROLL IA

STD5C019.CMP

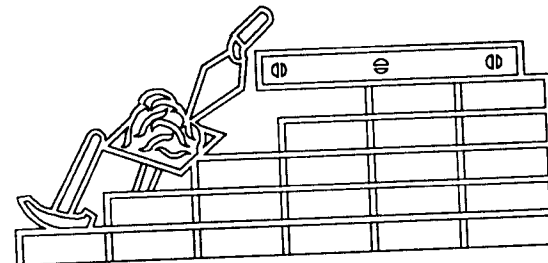

J. W. REYNOLDS MONUMENTS
VIENNA IL

STD5C020.CMP

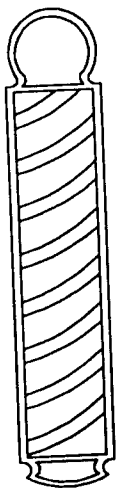

J. W. REYNOLDS MONUMENTS
VIENNA IL

STD5C021.CMP

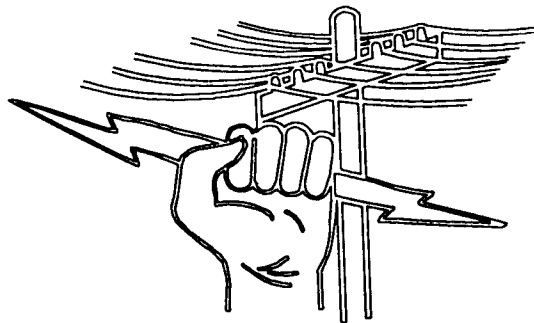

J. W. REYNOLDS MONUMENTS
VIENNA IL

STD5C022.CMP

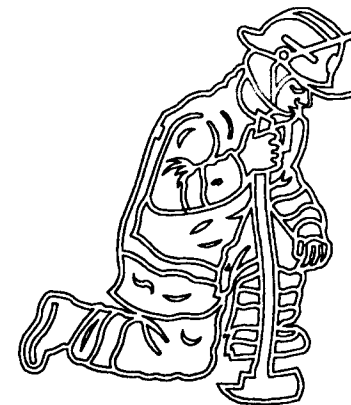

CAPITOL HILL MONUMENT
OKLAHOMA CITY OK

STD5C023.CMP

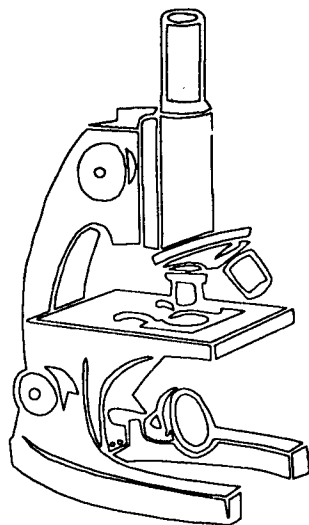

BEESELY MONUMENT CO
PROVO UT

STD5C024.CMP

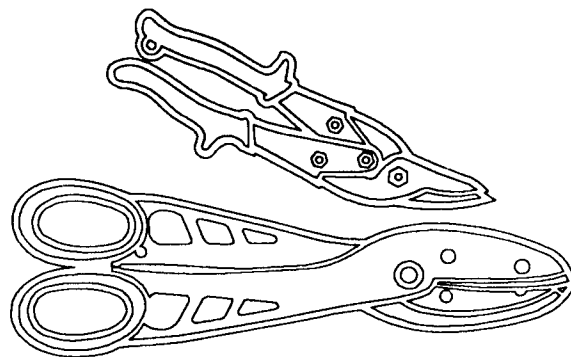

BEESELY MONUMENT CO
PROVO UT

STD5C025.CMP

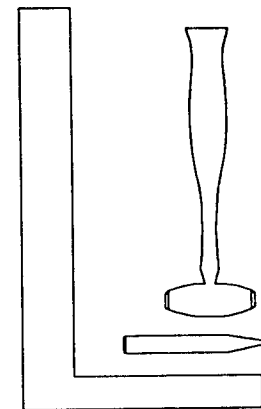

SCHAEFER MONUMENT CO
ST. LOUIS MO

STD5C026.CMP

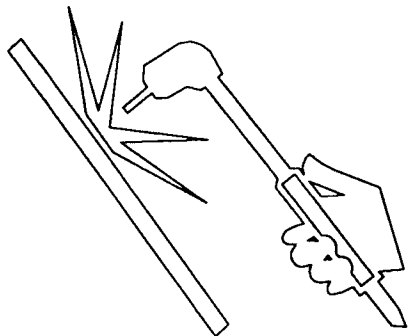

L. J. SERVICES
CHERRY VALLEY NY

STD5C027.CMP

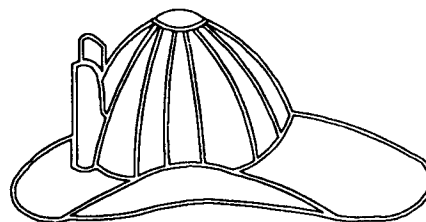

RINKER & FRYE MEMORIALS
MT. JACKSON VA

STD5C028.CMP

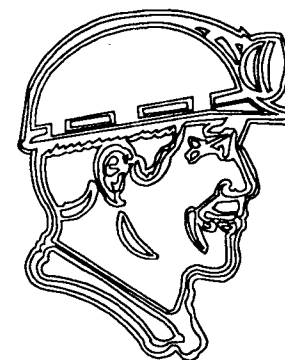

GRIMES BROS. GRANITE CO
ELBERTON GA

STD5C029.CMP

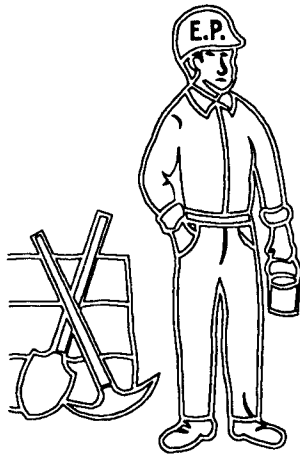

GRIMES BROS. GRANITE CO
ELBERTON GA

STD5C030.CMP

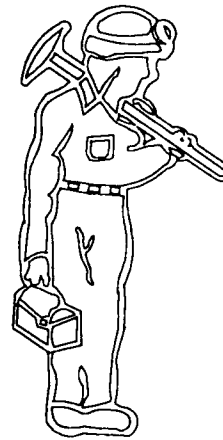

GRIMES BROS. GRANITE CO
ELBERTON GA

STD5C031.CMP



OREGON GRANITE CO
MEDFORD OR

STD5C032.CMP

R

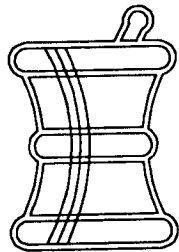

PEEBLES MONUMENT CO
PEEBLES OH

STD5C033.CMP



PEEBLES MONUMENT CO
PEEBLES OH

STD5C034.CMP

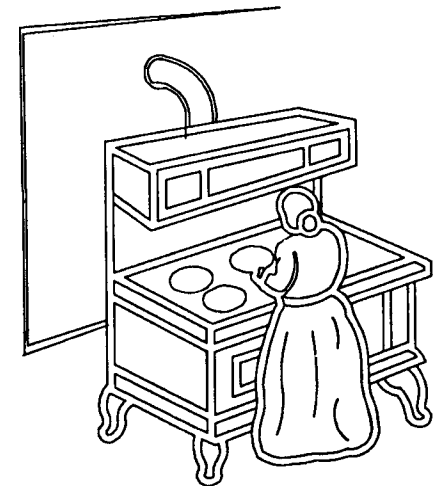

PEEBLES MONUMENT CO
PEEBLES OH

STD5C035.CMP

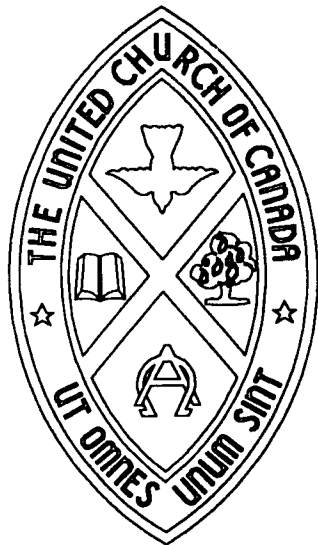

STAFFORD MONUMENTS
WHITBY ONTARIO STD5E001 .CMP



STAFFORD MONUMENTS
WHITBY ONTARIO STD5E002 .CMP



STAFFORD MONUMENTS
WHITBY ONTARIO STD5E003 .CMP



STAFFORD MONUMENTS
WHITBY ONTARIO STD5E004 .CMP



CAMDEN MONUMENT CO.
CAMDEN AR STD5E005 .CMP

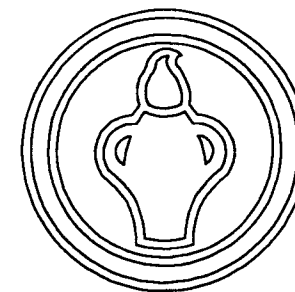

CAMDEN MONUMENT CO.
CAMDEN AR STD5E006 .CMP



CAMDEN MONUMENT CO.
CAMDEN AR STD5E007.CMP

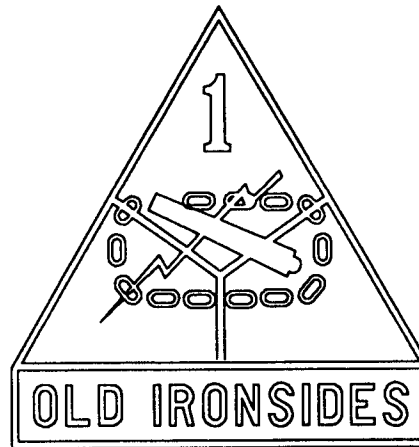

CAMDEN MONUMENT CO.
CAMDEN AR STD5E008.CMP



CAMDEN MONUMENT CO.
CAMDEN AR STD5E009.CMP

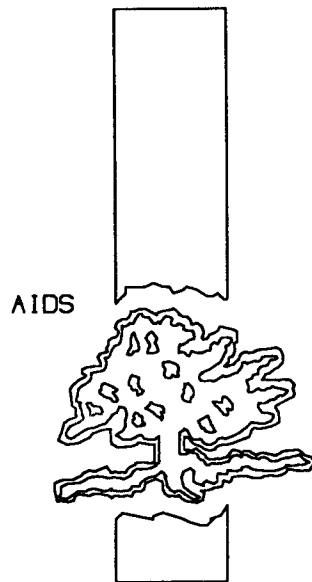

PIQUA GRANITE & MARBLE
PIQUA OH STD5E010.CMP



PIQUA GRANITE & MARBLE
PIQUA OH STD5E011.CMP



PIQUA GRANITE & MARBLE
PIQUA OH STD5E012.CMP

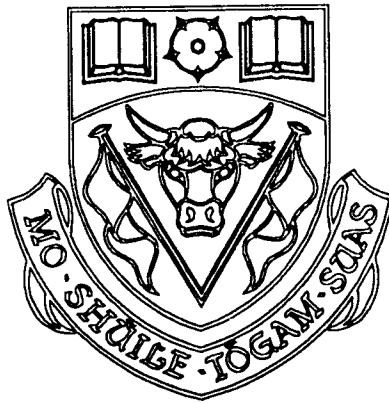

EVERGREEN MEMORIALS
CALGARY ALBERTA

STD5E013 .CMP



CENTRAL GRANITE CO.
ELBERTON GA

STD5E014 .CMP

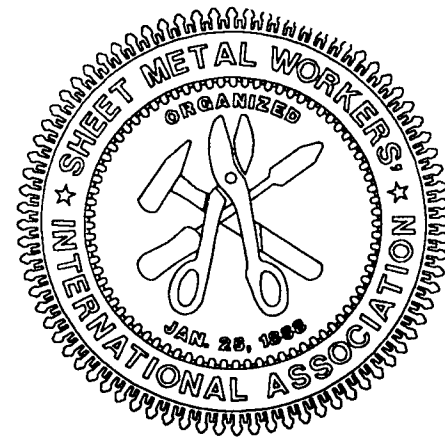

CENTRAL GRANITE CO.
ELBERTON GA

STD5E015 .CMP

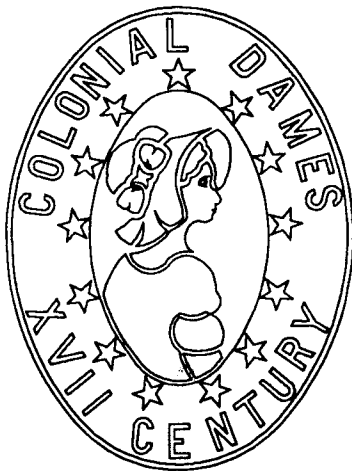

N.C. MARBLE & GRANITE
CLINTON NC

STD5E016 .CMP

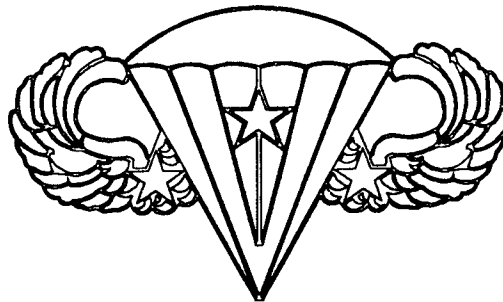

N.C. MARBLE & GRANITE
CLINTON NC

STD5E017 .CMP

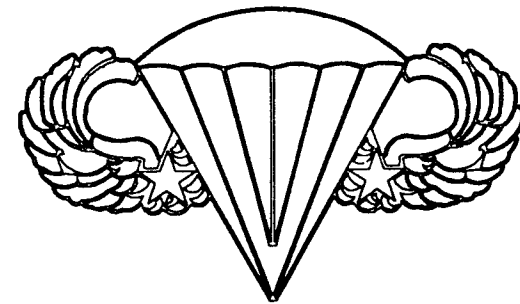

N.C. MARBLE & GRANITE
CLINTON NC

STD5E018 .CMP

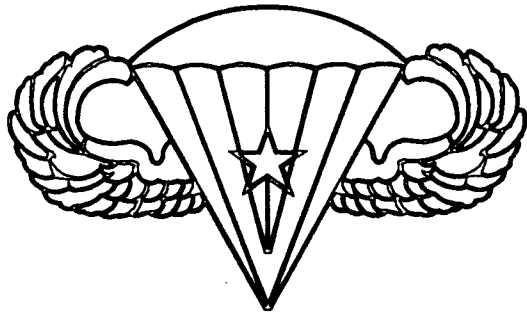

N. C. MARBLE & GRANITE
CLINTON NC

STD5E019.CMP

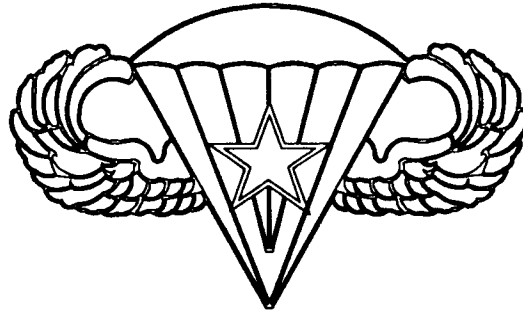

N. C. MARBLE & GRANITE
CLINTON NC

STD5E020.CMP

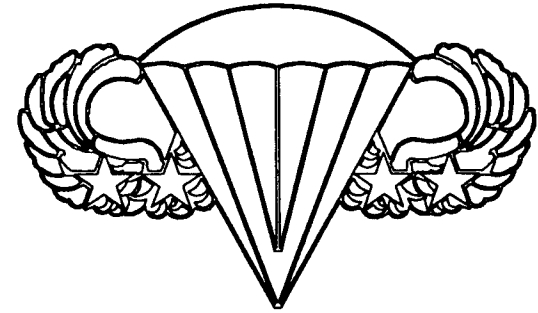

N. C. MARBLE & GRANITE
CLINTON NC

STD5E021.CMP



N. C. MARBLE & GRANITE
CLINTON NC

STD5E022.CMP

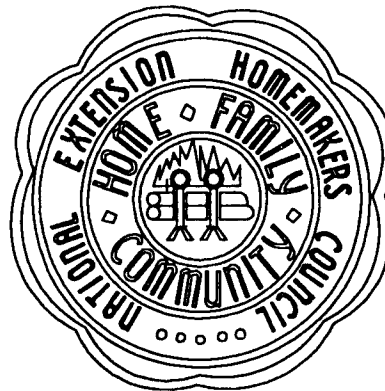

N. C. MARBLE & GRANITE
CLINTON NC

STD5E023.CMP

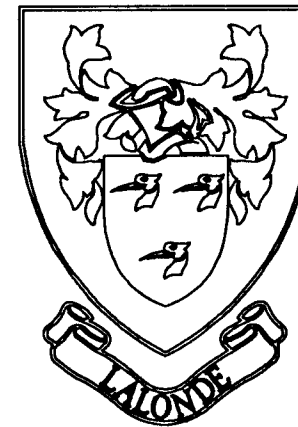

GRANITE LACROIX
VIMONT-LAVAL QUEBEC

STD5E024.CMP

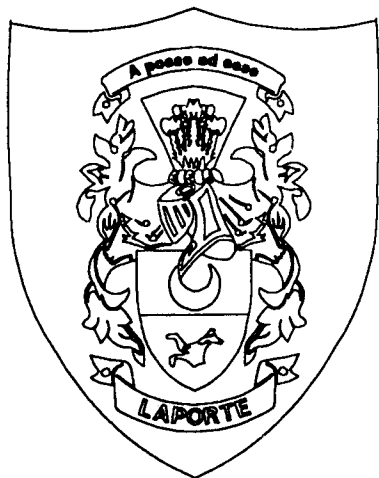

GRANITE LACROIX
VIMONT-LAVAL QUEBEC
STD5E025 .CMP

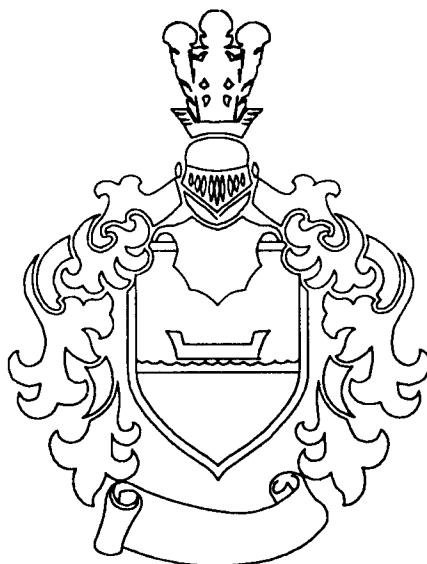

GRANITE LACROIX
VIMONT-LAVAL QUEBEC
STD5E026 .CMP

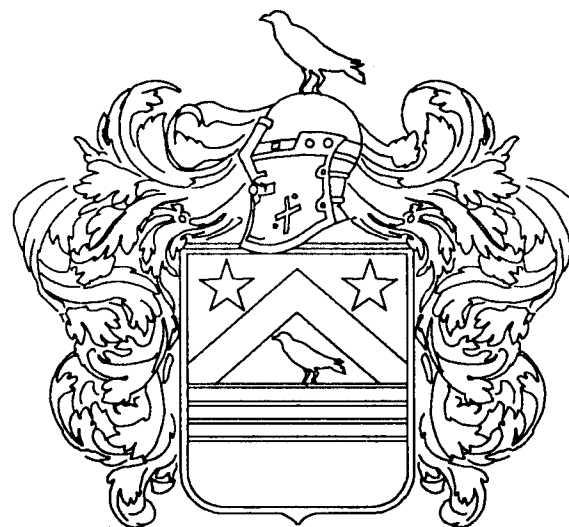

GRANITE LACROIX
VIMONT-LAVAL QUEBEC
STD5E027 .CMP

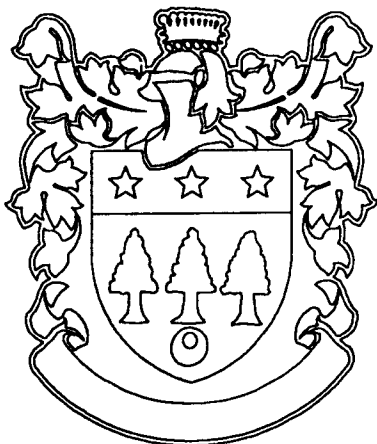

GRANITE LACROIX
VIMONT-LAVAL QUEBEC
STD5E028 .CMP

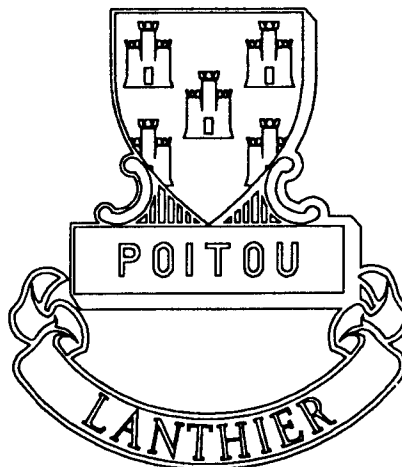

GRANITE LACROIX
VIMONT-LAVAL QUEBEC
STD5E029 .CMP

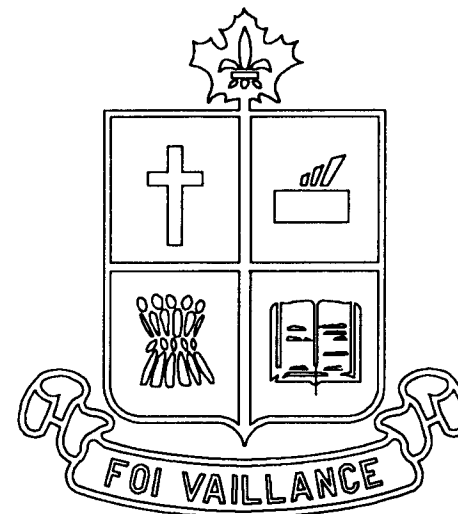

GRANITE LACROIX
VIMONT-LAVAL QUEBEC
STD5E030 .CMP

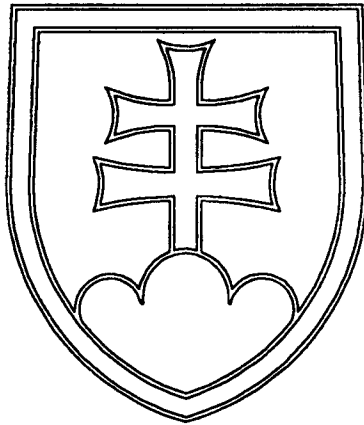

GRANITE LACROIX
VIMONT-LAVAL QUEBEC
STD5E031.CMP

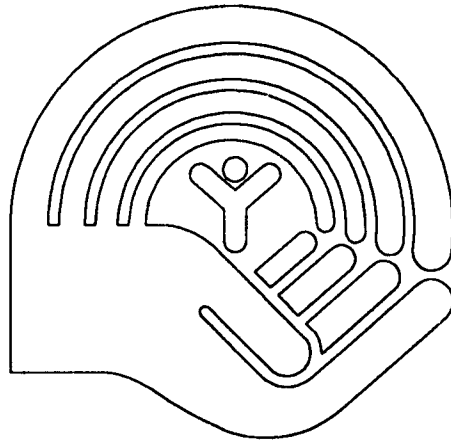

EDWIN F. NICKOL
VERSAILLES OH
STD5E032.CMP

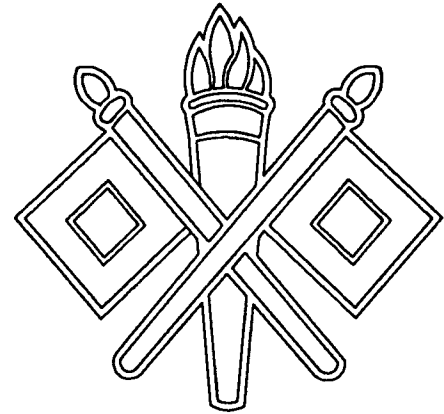

MASTERCARVED MEMORIALS
CLAY CENTER KS
STD5E033.CMP



MASTERCARVED MEMORIALS
CLAY CENTER KS
STD5E034.CMP

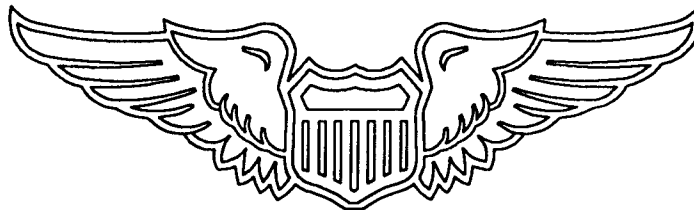

MASTERCARVED MEMORIALS
CLAY CENTER KS
STD5E035.CMP

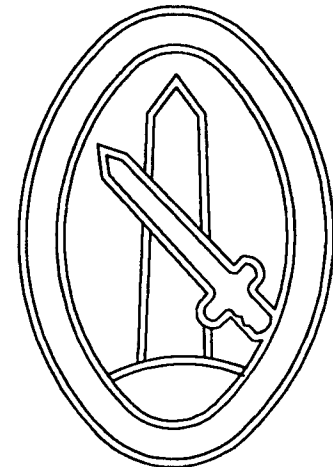

MASTERCARVED MEMORIALS
CLAY CENTER KS
STD5E036.CMP

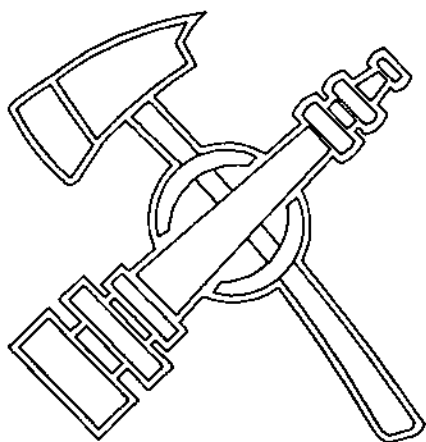

SEAMON-POE MONUMENT CO.
SAN DIEGO CA

STD5E037.CMP

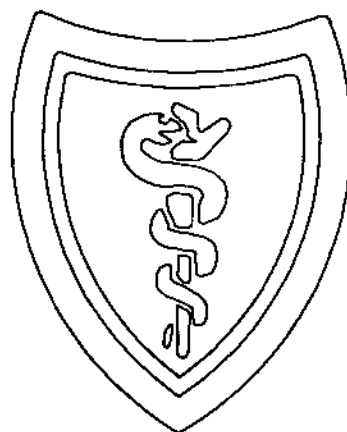

SEAMON-POE MONUMENT CO.
SAN DIEGO CA

STD5E038.CMP

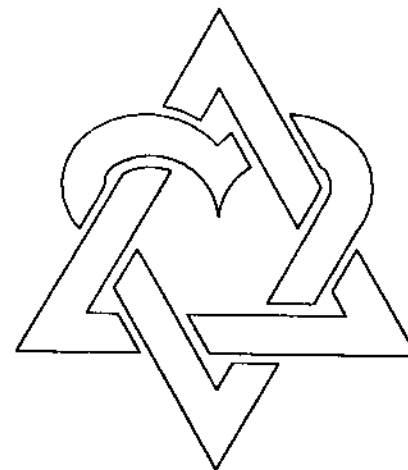

SEAMON-POE MONUMENT CO.
SAN DIEGO CA

STD5E039.CMP

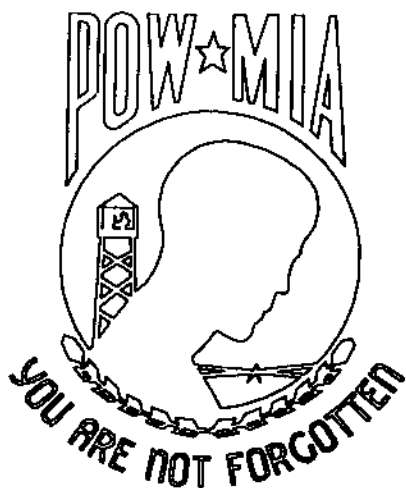

KEITH MONUMENT CO.
ELIZABETHTOWN KY

STD5E040.CMP



KEITH MONUMENT CO.
ELIZABETHTOWN KY

STD5E041.CMP



MILLER BROS. MONUMENT
IOWA CITY IA

STD5E042.CMP

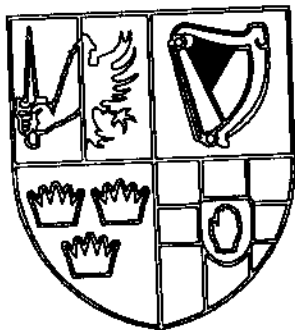

ADVANCED MEMORIAL DESIGN
MORRISTOWN TN

STD5E043.CMP

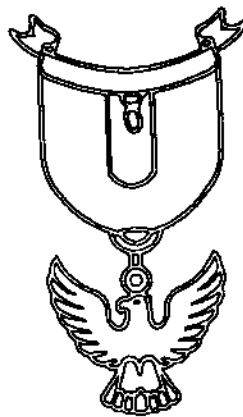

ADVANCED MEMORIAL DESIGN
MORRISTOWN TN

STD5E044.CMP

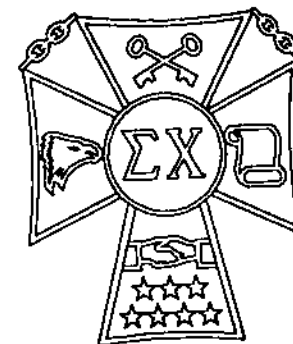

ADVANCED MEMORIAL DESIGN
MORRISTOWN TN

STD5E045.CMP



MILLIGAN MEMORIALS
COSHOCOTON OH

STD5E046.CMP

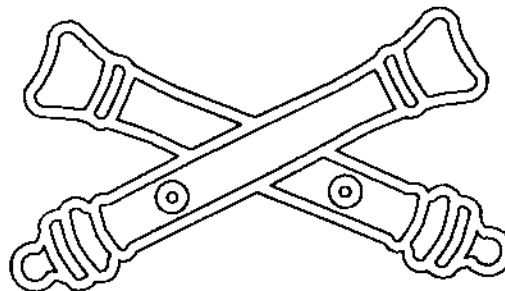

MILLIGAN MEMORIALS
COSHOCOTON OH

STD5E047.CMP

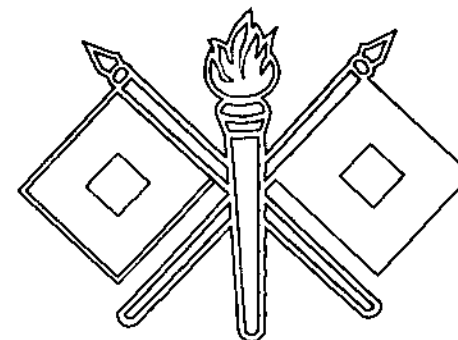

MILLIGAN MEMORIALS
COSHOCOTON OH

STD5E048.CMP



BOYCE MONUMENTAL SALES LTD
CARROLL IA

STD5E049.CMP

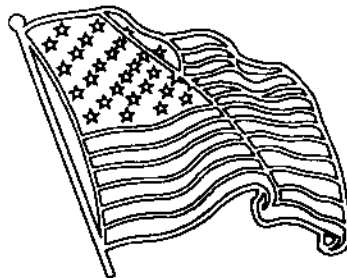

RMG STONE PRODUCTS
CASTLETON VT

STD5E050.CMP



LONGSTRETH MEMORIALS
GALION OH

STD5E051.CMP



LONGSTRETH MEMORIALS
GALION OH

STD5E052.CMP



J.W. REYNOLDS MONUMENTS
VIENNA IL

STD5E053.CMP

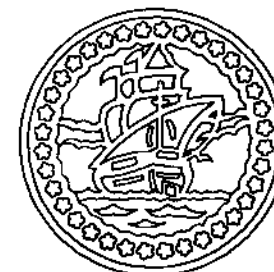

J.W. REYNOLDS MONUMENTS
VIENNA IL

STD5E054.CMP



J.W. REYNOLDS MONUMENTS
VIENNA IL

STD5E055.CMP

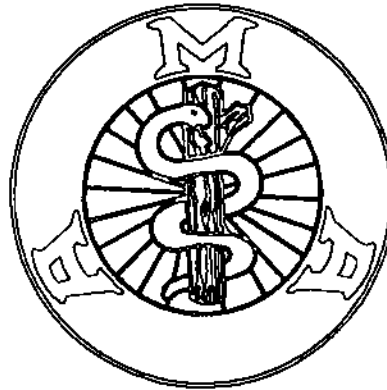

W.P. SIMMONS INC
MT. AIRY NC

STD5E056.CMP



W.P. SIMMONS INC
MT. AIRY NC

STD5E057.CMP



SMYTH MEMORIAL CO
CHATHAM ONTARIO CANADA

STD5E058.CMP



SMYTH MEMORIAL CO
CHATHAM ONTARIO CANADA

STD5E059.CMP



SMYTH MEMORIAL CO
CHATHAM ONTARIO CANADA

STD5E060.CMP



SMYTH MEMORIAL CO
CHATHAM ONTARIO CANADA

STD5E061.CMP



SMYTH MEMORIAL CO
CHATHAM ONTARIO CANADA

STD5E082.CMP



SMYTH MEMORIAL CO
CHATHAM ONTARIO CANADA

STD5E063.CMP



SMYTH MEMORIAL CO
CHATHAM ONTARIO CANADA

STD5E064.CMP



MOORE MONUMENT CO
CHILLICOTHE MO

STD5E065.CMP

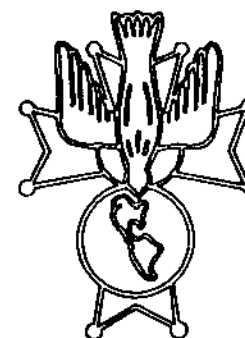

JAMESTOWN MONUMENT
JAMESTOWN ND

STD5E066.CMP



McGARRY MEMORIALS
CHORLTON MANCHESTER UK
STD5E067.CMP

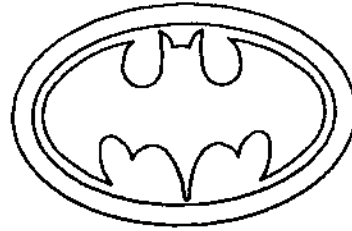

SOUTH BEND MONUMENT WORKS
SOUTH BEND IN
STD5E068.CMP



SOUTH BEND MONUMENT WORKS
SOUTH BEND IN
STD5E069.CMP



BARRE MEMORIALS
HYDE PARK NY
STD5E070.CMP

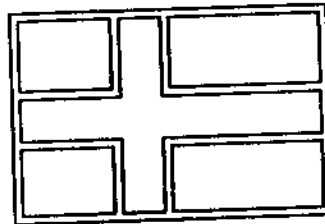

BARRE MEMORIALS
HYDE PARK NY
STD5E071.CMP

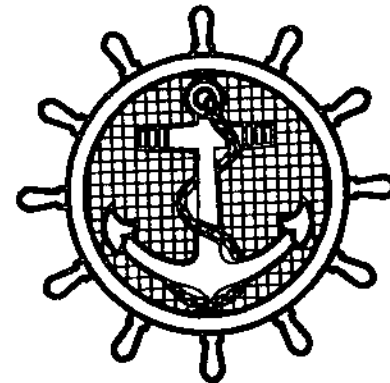

KIRKPATRICK & O'BRINE LTD
FONTHILL ONTARIO CANADA
STD5E072.CMP

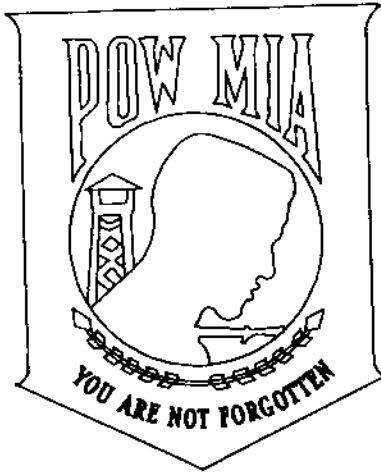

WOODSIDE GRANITE
ALBION NY

STD5E073 .CMP

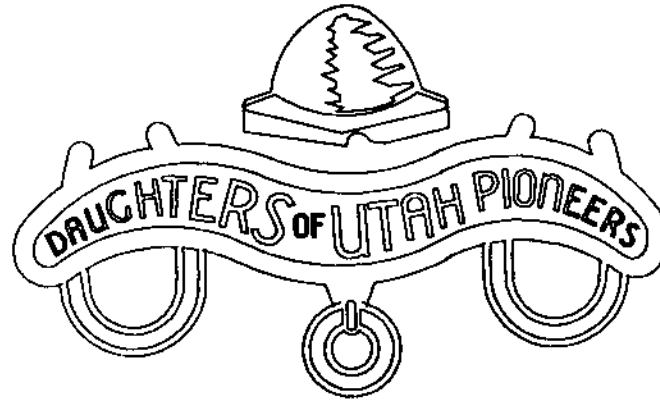

BROWN MONUMENT
LOGAN UT

STD5E074 .CMP

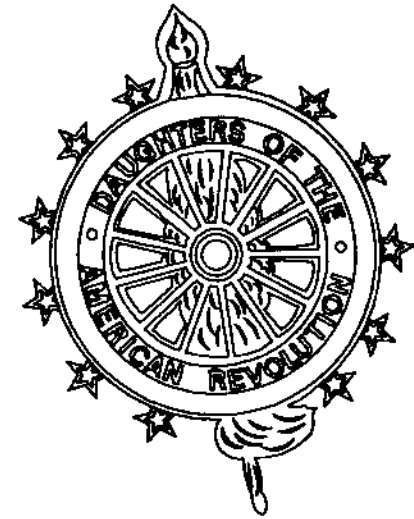

FOREST PARK MEMORIALS
HOUSTON TX

STD5E075 .CMP

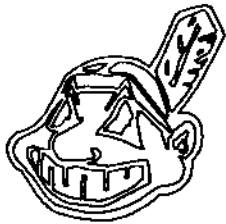

L. J. SERVICES
CHERRY VALLEY NY

STD5E076 .CMP



VISALIA GRANITE & MARBLE WORKS
VISALIA CA

STD5E077 .CMP

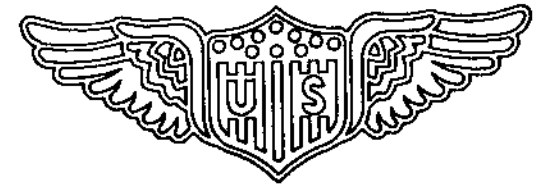

VISALIA GRANITE & MARBLE WORKS
VISALIA CA

STD5E078 .CMP

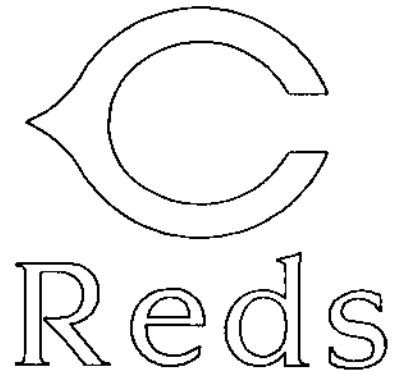

WEARLY MONUMENTS
MUNCIE IN

STD5E079.CMP



LANDMARK GRANITE CO
ELBERTON GA

STD5E080.CMP



LANDMARK GRANITE CO
ELBERTON GA

STD5E081.CMP



RINKER & FRYE MEMORIALS
MT. JACKSON VA

STD5E082.CMP



GRIMES BROS. GRANITE CO
ELBERTON GA

STD5E083.CMP

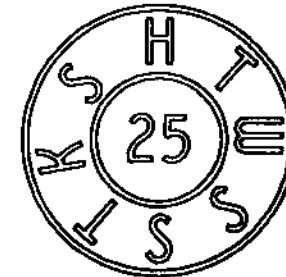

GRIMES BROS. GRANITE CO
ELBERTON GA

STD5E084.CMP

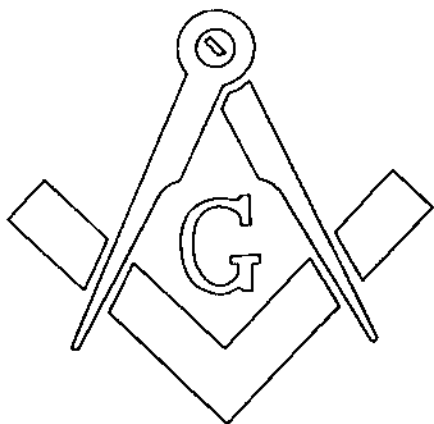

PLOUFF'S MONUMENT CO
ST. ALBANS VT

STD5E085.CMP



PLOUFF'S MONUMENT CO
ST. ALBANS VT

STD5E086.CMP

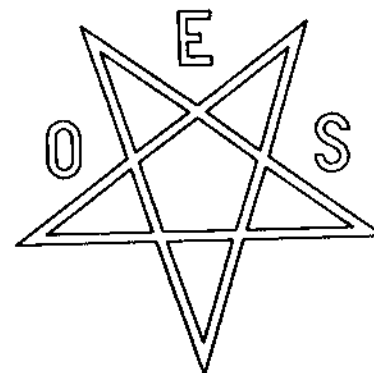

PLOUFF'S MONUMENT CO
ST. ALBANS VT

STD5E087.CMP



PHOENIXVILLE MEMORIAL WORKS
PHOENIXVILLE PA

STD5E088.CMP

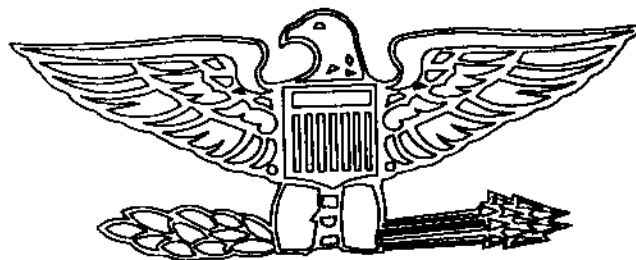

BREWER MONUMENT CO
PERRYVILLE MO

STD5E089.CMP



BREWER MONUMENT CO
PERRYVILLE MO

STD5E090.CMP

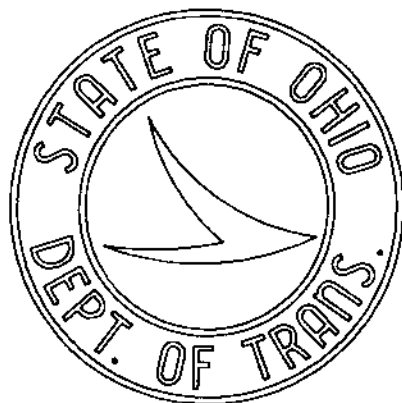

PEEBLES MONUMENT CO
PEEBLES OH

STD5E091 .CMP



CHERRY VALLEY MEMORIALS
CHERRY VALLEY NY

STD5E092 .CMP



ADAMS MEMORIALS
CHARLESTON IL

STD5E093 .CMP



ADAMS MEMORIALS
CHARLESTON IL

STD5E094 .CMP



ADAMS MEMORIALS
CHARLESTON IL

STD5E095 .CMP

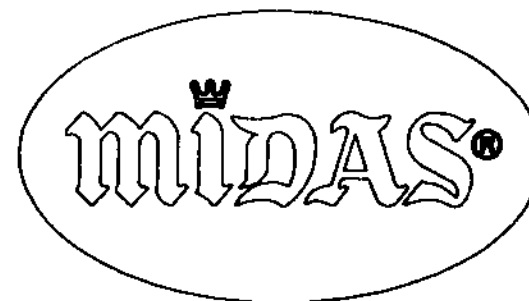

ADAMS MEMORIALS
CHARLESTON IL

STD5E096 .CMP

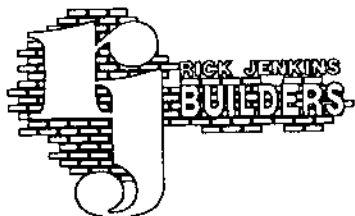

ADAMS MEMORIALS
CHARLESTON IL

STD5E097.CMP

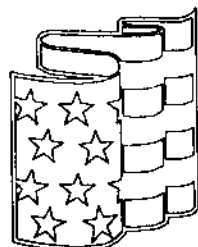

AmBank

Member AMBANC Corp.

ADAMS MEMORIALS
CHARLESTON IL

STD5E098.CMP



ADAMS MEMORIALS
CHARLESTON IL

STD5E099.CMP



ADAMS MEMORIALS
CHARLESTON IL

STD5E100.CMP

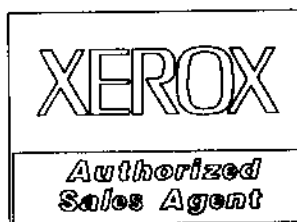

ADAMS MEMORIALS
CHARLESTON IL

STD5E101.CMP



ADAMS MEMORIALS
CHARLESTON IL

STD5E102.CMP



ADAMS MEMORIALS
CHARLESTON IL

STD5E103.CMP



ADAMS MEMORIALS
CHARLESTON IL

STD5E104.CMP



ADAMS MEMORIALS
CHARLESTON IL

STD5E105.CMP



ADAMS MEMORIALS
CHARLESTON IL

STD5E106.CMP



ADAMS MEMORIALS
CHARLESTON IL

STD5E107.CMP



ADAMS MEMORIALS
CHARLESTON IL

STD5E108.CMP



ADAMS MEMORIALS
CHARLESTON IL

STD5E109.CMP



ADAMS MEMORIALS
CHARLESTON IL

STD5E110.CMP



ADAMS MEMORIALS
CHARLESTON IL

STD5E111.CMP

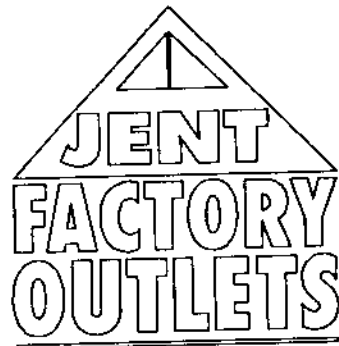

ADAMS MEMORIALS
CHARLESTON IL

STD5E112.CMP

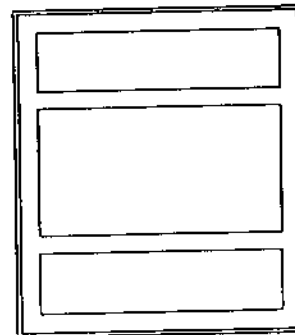

MEMBER OLD NATIONAL BANCORP

ADAMS MEMORIALS
CHARLESTON IL

STD5E113.CMP



ADAMS MEMORIALS
CHARLESTON IL

STD5E114.CMP

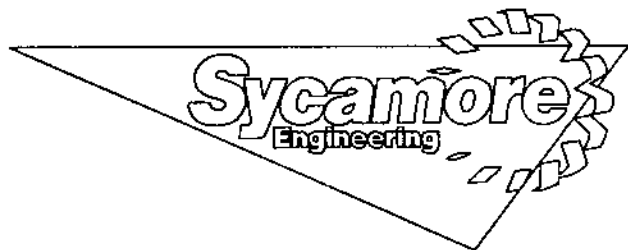

ADAMS MEMORIALS
CHARLESTON IL

STD5E115.CMP



ADAMS MEMORIALS
CHARLESTON IL

STD5E116.CMP



ADAMS MEMORIALS
CHARLESTON IL

STD5E117.CMP

BRAVES



ADAMS MEMORIALS
CHARLESTON IL

STD5E118.CMP

We'll remember you

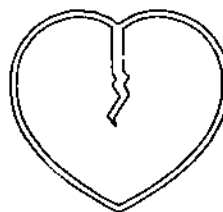

MADD

WEARLY MONUMENTS
MUNCIE IN

STD5E119.CMP



WEARLY MONUMENTS
MUNCIE IN

STD5E120.CMP





STAFFORD MONUMENTS
WHITBY ONTARIO
STD5F001.CMP

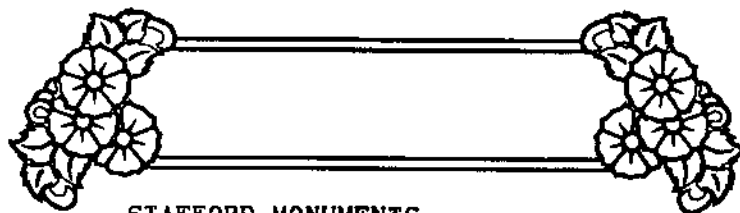

STAFFORD MONUMENTS
WHITBY ONTARIO STD5F002.CMP



STAFFORD MONUMENTS
WHITBY ONTARIO
STD5F003.CMP

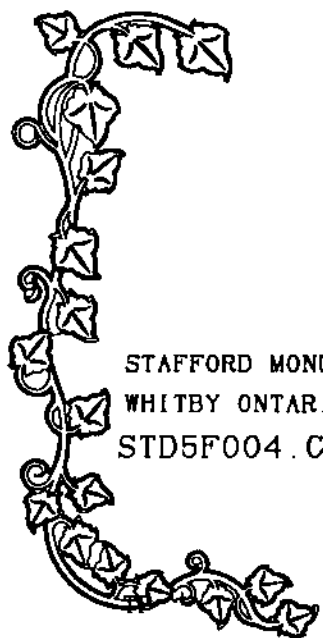

STAFFORD MONUMENTS
WHITBY ONTARIO
STD5F004.CMP

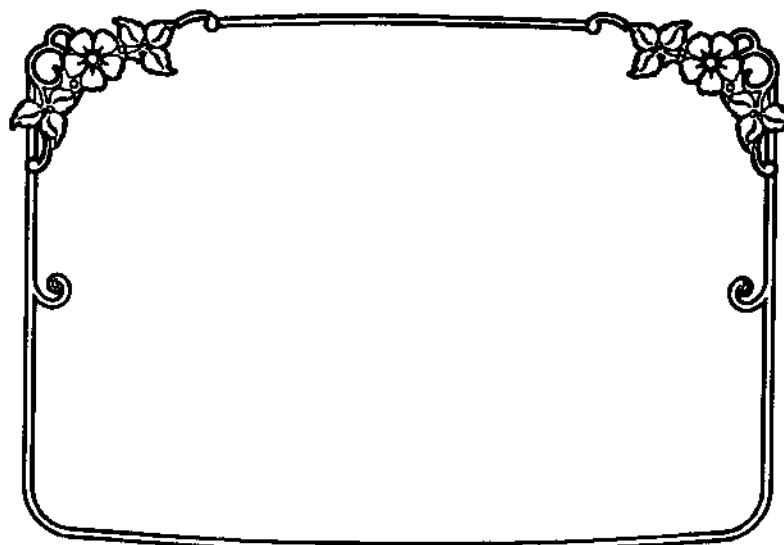

STAFFORD MONUMENTS
WHITBY ONTARIO STD5F005.CMP



STAFFORD MONUMENTS
WHITBY ONTARIO
STD5F006.CMP



STAFFORD MONUMENTS
WHITBY ONTARIO
STD5F007.CMP



STAFFORD MONUMENTS
WHITBY ONTARIO



STD5F008.CMP

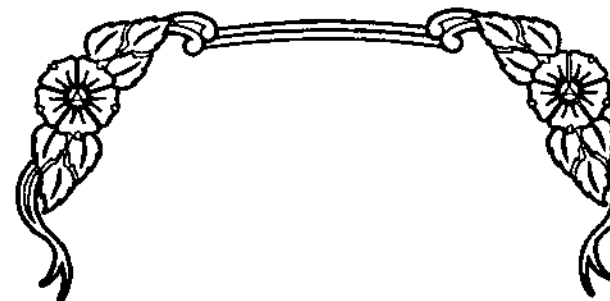

STAFFORD MONUMENTS
WHITBY ONTARIO
STD5F009.CMP

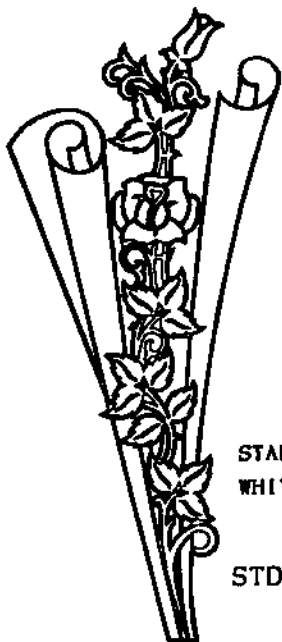

STAFFORD MONUMENTS
WHITBY ONTARIO
STD5F010.CMP

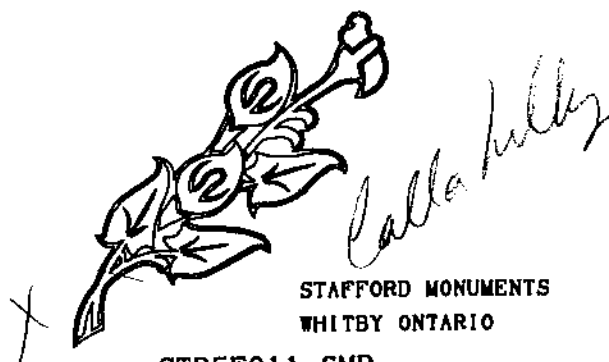

STAFFORD MONUMENTS
WHITBY ONTARIO
STD5F011.CMP



TULSA MONUMENT CO.
TULSA OK

STD5F012.CMP

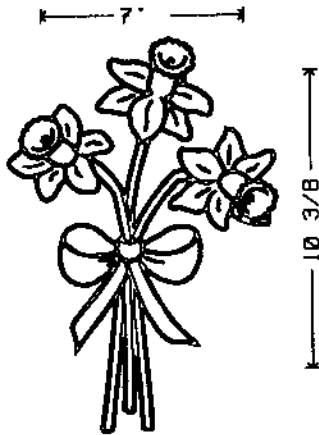

TULSA MONUMENT CO.
TULSA OK
STD5F013.CMP



CAMDEN MONUMENT CO.
CAMDEN AR
STD5F014.CMP

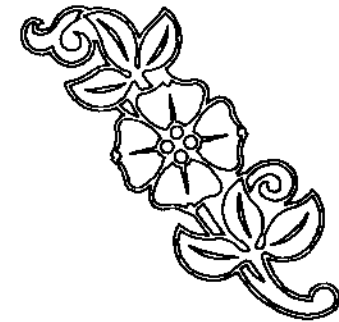

CAMDEN MONUMENT CO.
CAMDEN AR
STD5F015.CMP

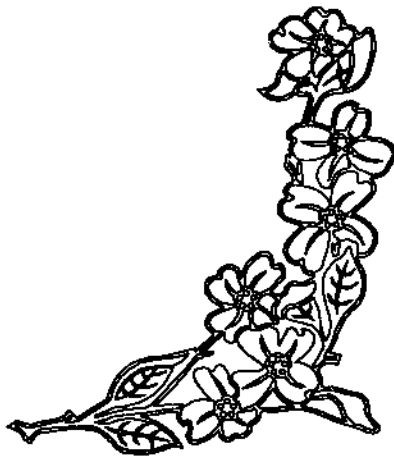

CAMDEN MONUMENT CO.
CAMDEN AR
STD5F016.CMP

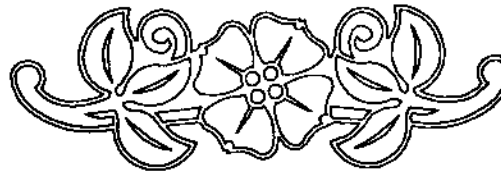

CAMDEN MONUMENT CO.
CAMDEN AR
STD5F017.CMP

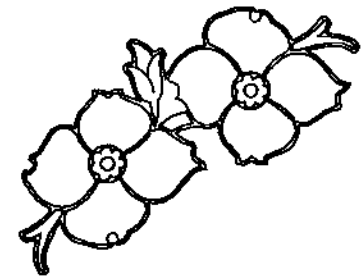

SANDZIMIER MEMORIALS
SCOTTDALE PA
STD5F018.CMP



PIQUA GRANITE & MARBLE
PIQUA OH STD5F019.CMP



PIQUA GRANITE & MARBLE
PIQUA OH STD5F020.CMP



EVERGREEN MEMORIALS
CALGARY ALBERTA STD5F021.CMP



EVERGREEN MEMORIALS
CALGARY ALBERTA STD5F022.CMP



EVERGREEN MEMORIALS
CALGARY ALBERTA STD5F023.CMP



EVERGREEN MEMORIALS
CALGARY ALBERTA STD5F024.CMP



EVERGREEN MEMORIALS
CALGARY ALBERTA STD5F025.CMP



EVERGREEN MEMORIALS
CALGARY ALBERTA STD5F026.CMP

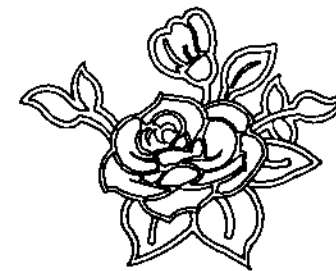

SAXON GRANITE
ELBERTON GA
STD5F027.CMP

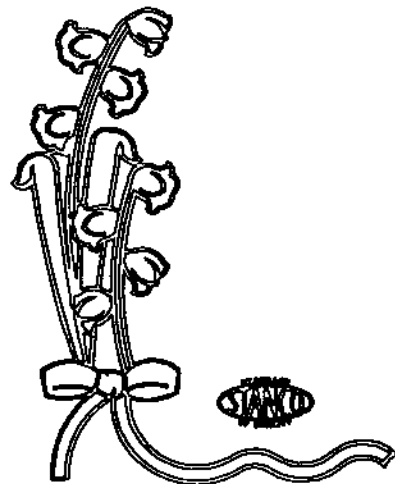

STANDARD GRANITE
ELBERTON GA
STD5F028.CMP

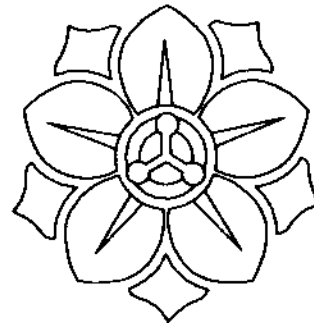

CENTRAL GRANITE CO.
ELBERTON GA
STD5F029.CMP

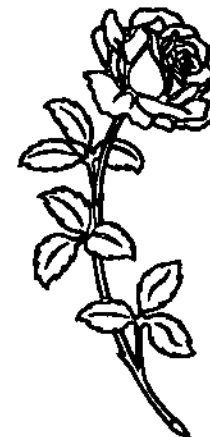

8.375 x 14.125
ARCHIE MON. & STONE
WATERTOWN WI
STD5F030.CMP

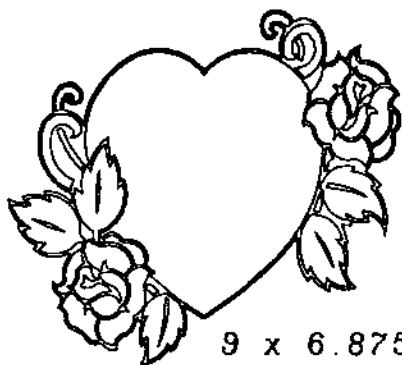

9 x 6.875

ARCHIE MON. & STONE
WATERTOWN WI

STD5F031.CMP

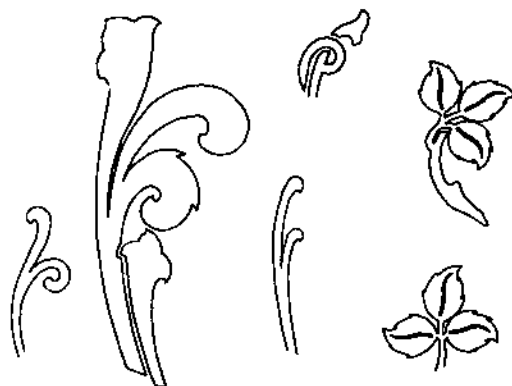

GRANITE LACROIX
VIMONT-LAVAL QUEBEC

STD5F032.CMP

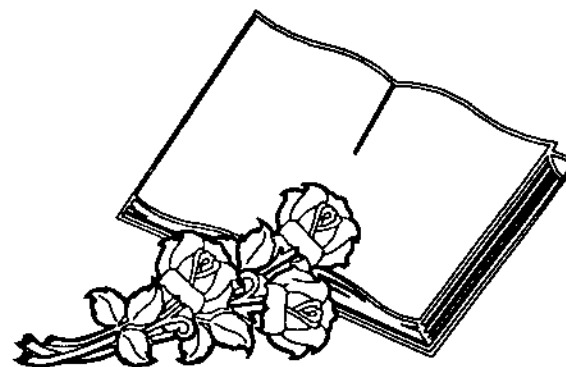

BREWER MONUMENT CO.
PERRYVILLE MO

STD5F033.CMP

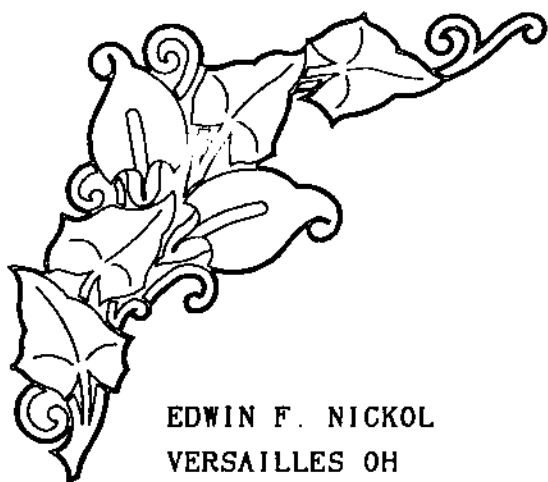

EDWIN F. NICKOL
VERSAILLES OH

STD5F034.CMP

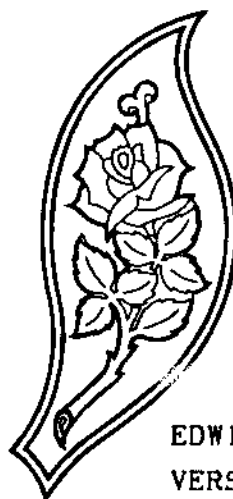

EDWIN F. NICKOL
VERSAILLES OH

STD5F035.CMP



EDWIN F. NICKOL
VERSAILLES OH

STD5F036.CMP

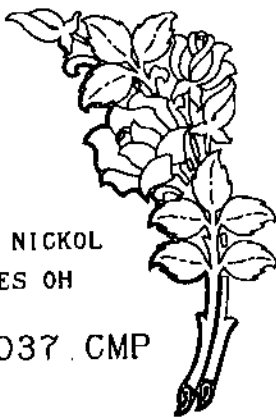

EDWIN F. NICKOL
VERSAILLES OH
STD5F037 .CMP



GALLAGHER MONUMENTS
MALAGA OH STD5F038 .CMP

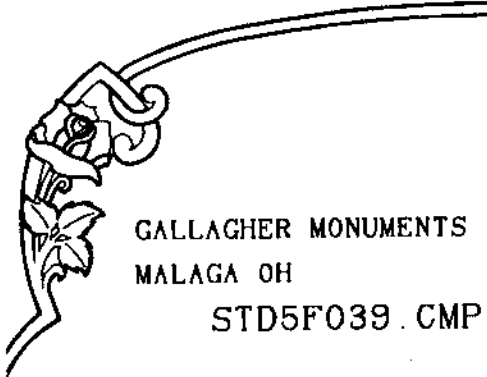

GALLAGHER MONUMENTS
MALAGA OH
STD5F039 .CMP

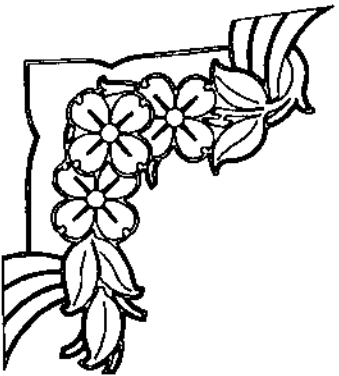

GALLAGHER MONUMENTS
MALAGA OH
STD5F040 .CMP

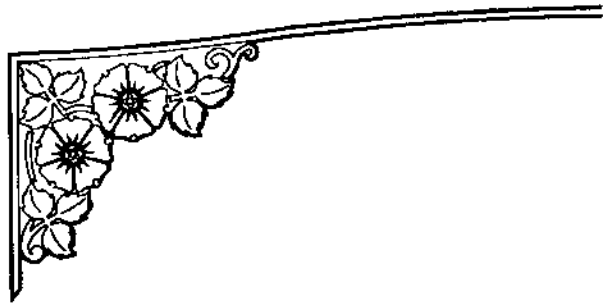

GALLAGHER MONUMENTS
MALAGA OH STD5F041 .CMP



GALLAGHER MONUMENTS
MALAGA OH
STD5F042 .CMP

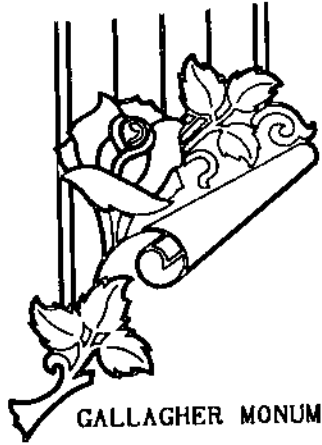

GALLAGHER MONUMENTS
MALAGA OH
STD5F043 .CMP

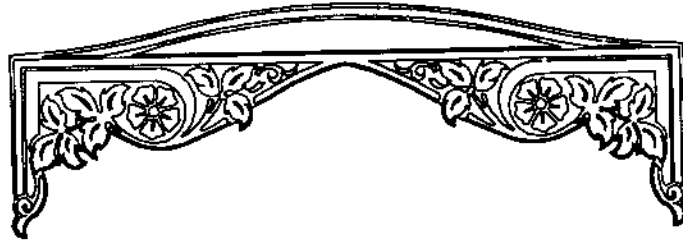

ERIE CITY MEMORIALS
ERIE PA
STD5F044 .CMP

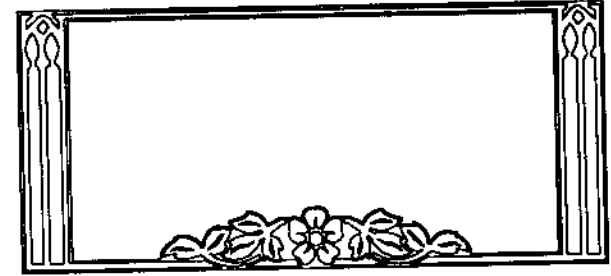

ERIE CITY MEMORIALS
ERIE PA
STD5F045 .CMP

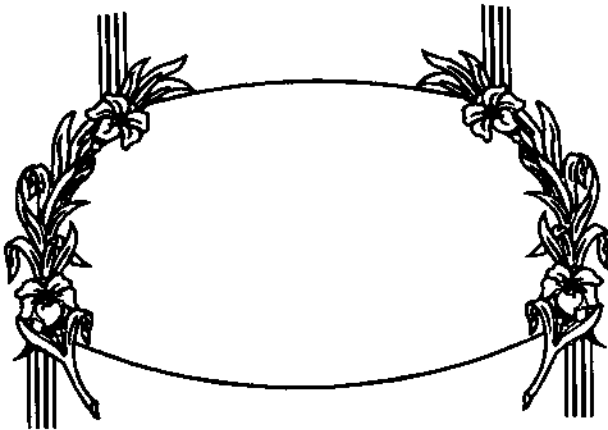

ERIE CITY MEMORIALS
ERIE PA
STD5F046 .CMP

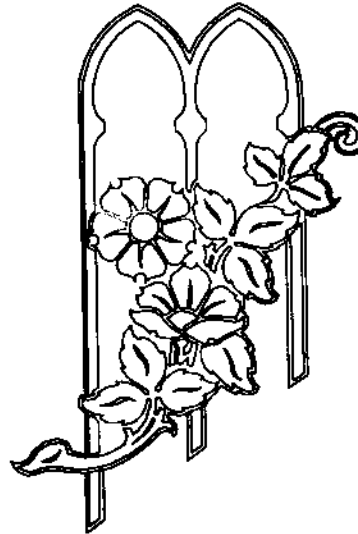

MASTERCARVED MEMORIALS
CLAY CENTER KS
STD5F047 .CMP

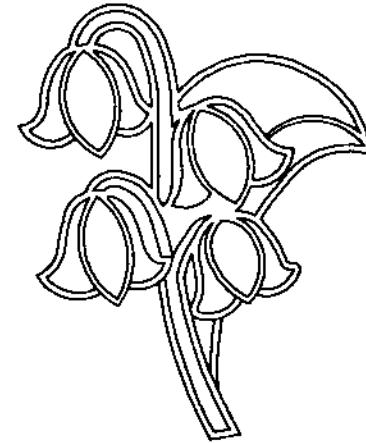

MASTERCARVED MEMORIALS
CLAY CENTER KS
STD5F048 .CMP

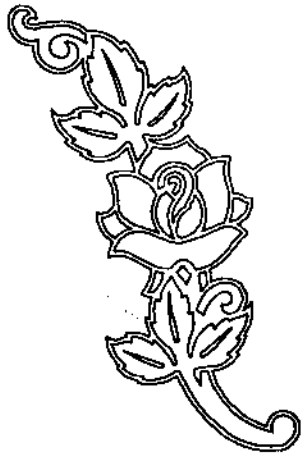

WOODWARD MONUMENT
VICI OK
STD5F049 .CMP

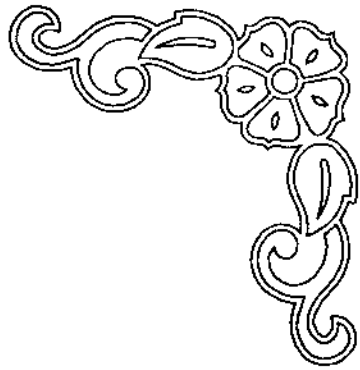

WOODWARD MONUMENT
VICI OK
STD5F050 .CMP

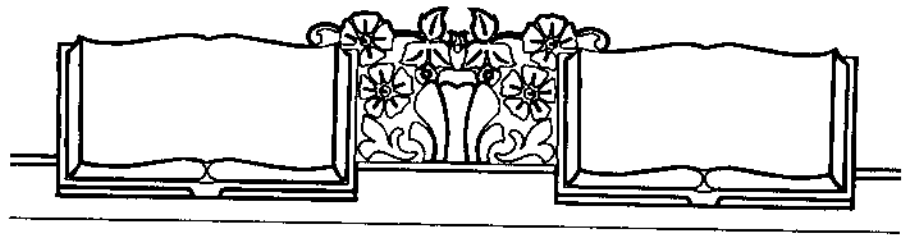

WOODWARD MONUMENT
VICI OK
STD5F051 .CMP

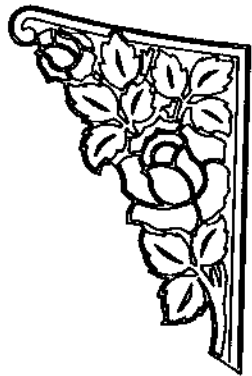

RUST-UNGER MONUMENTS
COLUMBUS IN
STD5F052 .CMP

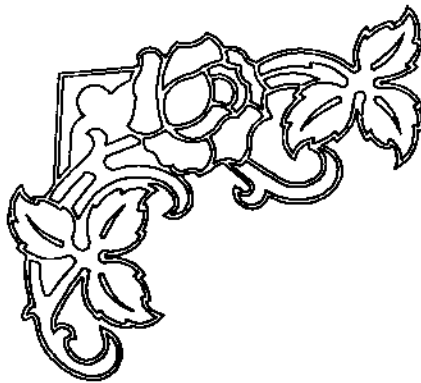

RUST-UNGER MONUMENTS
COLUMBUS IN
STD5F053 .CMP

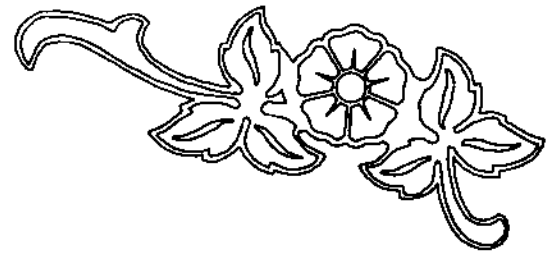

SEAMON-POE MONUMENT CO.
SAN DIEGO CA
STD5F054 .CMP

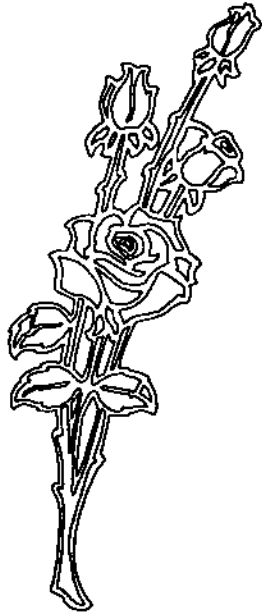

SEAMON-POE MONUMENT CO.
SAN DIEGO CA
STD5F055.CMP

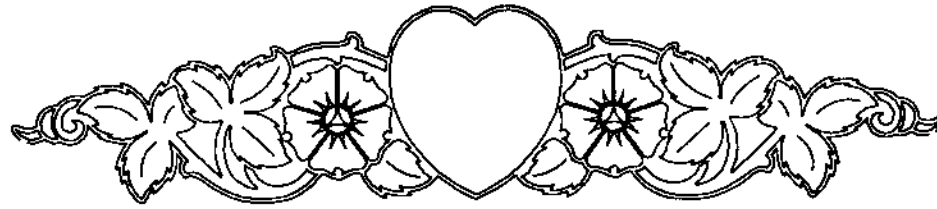

PLETZER MON. DESIGN
BARRE VT
STD5F056.CMP

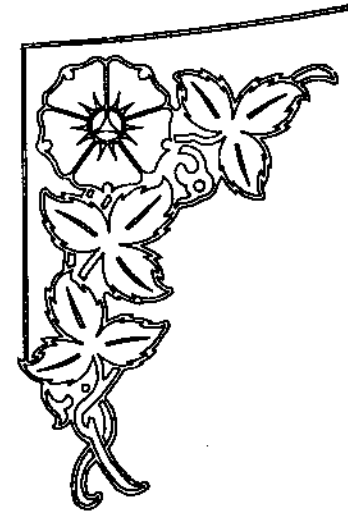

PLETZER MON. DESIGN
BARRE VT
STD5F057.CMP

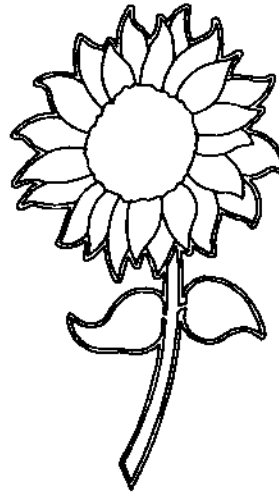

PLETZER MON. DESIGN
BARRE VT
STD5F059.CMP

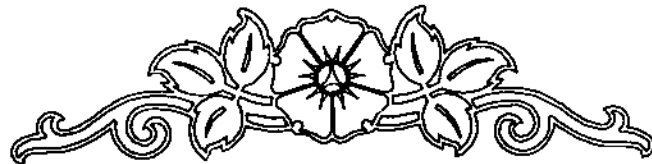

PLETZER MON. DESIGN
BARRE VT
STD5F058.CMP

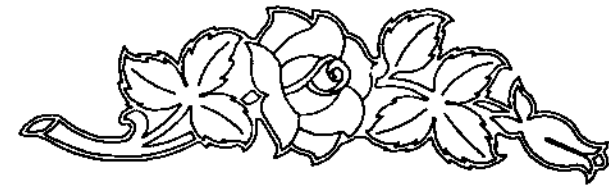

PLETZER MON. DESIGN
BARRE VT
STD5F060.CMP

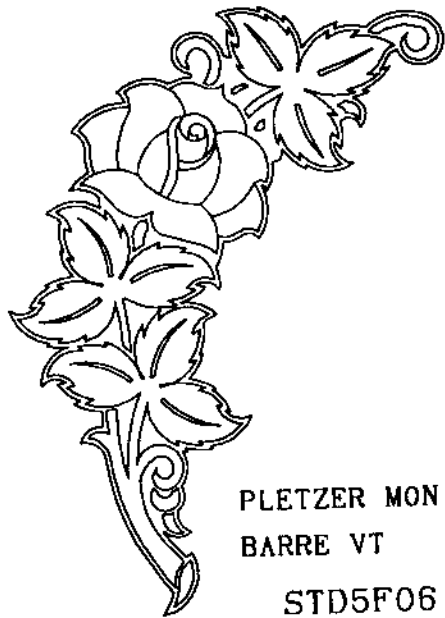

PLETZER MON. DESIGN
BARRE VT
STD5F061 .CMP

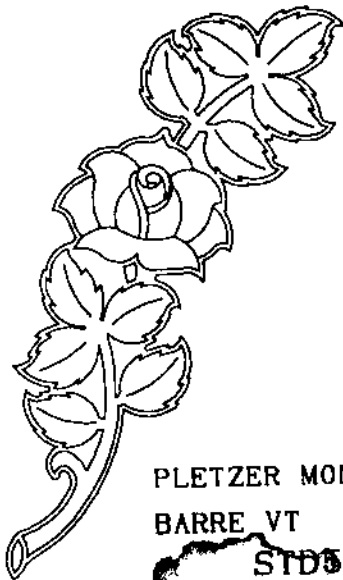

PLETZER MON. DESIGN
BARRE VT
STD5F062 .CMP



PLETZER MON. DESIGN
BARRE VT
STD5F063 .CMP



KEITH MONUMENT CO.
ELIZABETHTOWN KY
STD5F064 .CMP



PALMER MONUMENT CO.
BROKEN BOW NE
STD5F065 .CMP

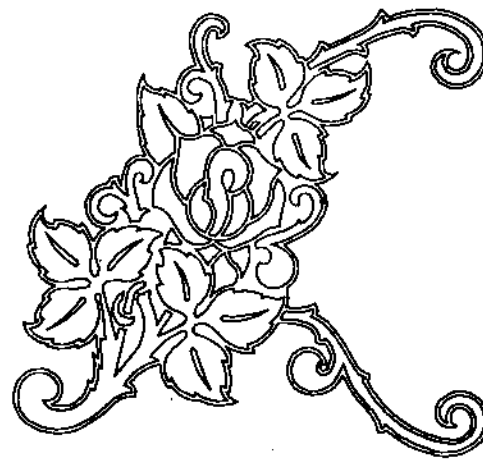

PALMER MONUMENT CO.
BROKEN BOW NE
STD5F066 .CMP

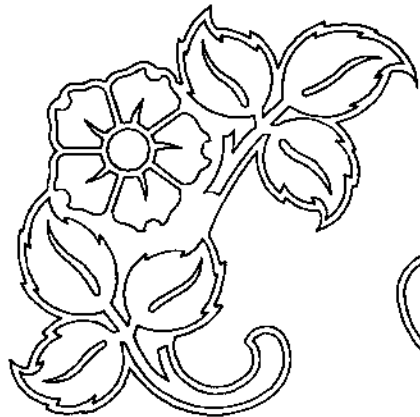

PALMER MONUMENT CO.
BROKEN BOW NE
STD5F067.CMP

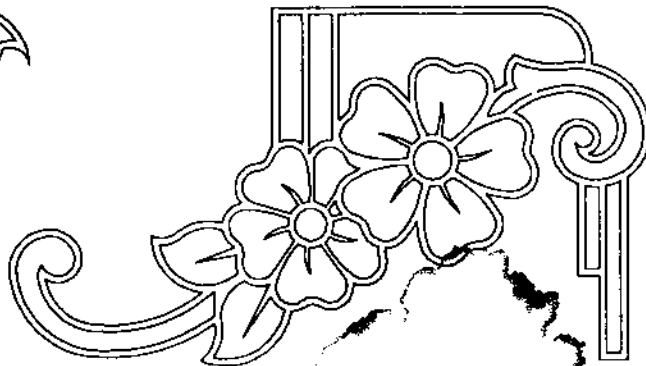

PALMER MONUMENT CO.
BROKEN BOW NE
STD5F068.CMP

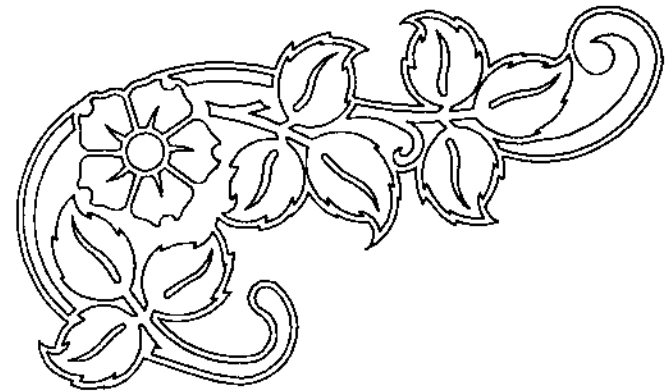

PALMER MONUMENT CO.
BROKEN BOW NE
STD5F069.CMP



PALMER MONUMENT CO.
BROKEN BOW NE
STD5F070.CMP

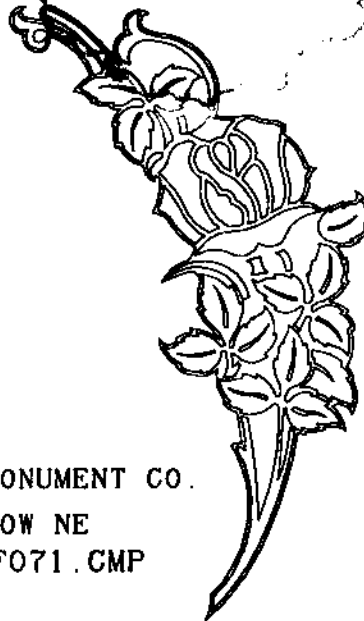

PALMER MONUMENT CO.
BROKEN BOW NE
STD5F071.CMP

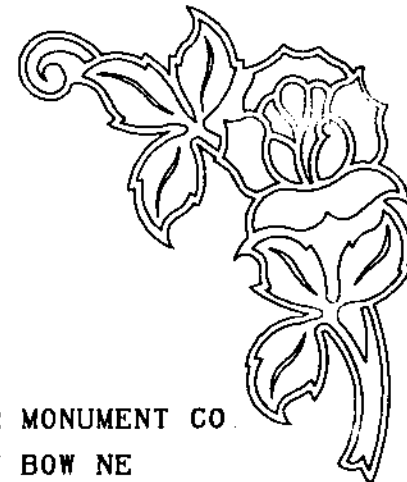

PALMER MONUMENT CO.
BROKEN BOW NE
STD5F072.CMP



PALMER MONUMENT CO.
BROKEN BOW NE
STD5F073.CMP

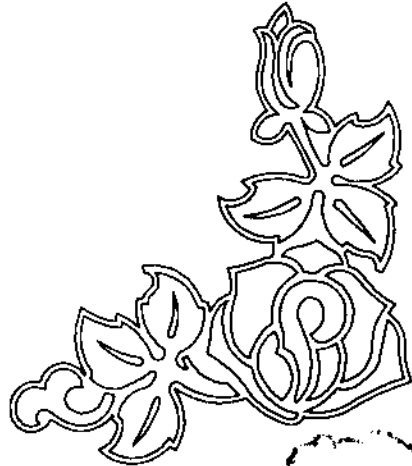

PALMER MONUMENT CO.
BROKEN BOW NE
STD5F074.CMP

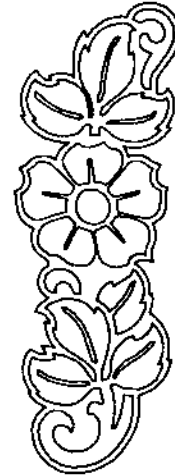

ELBERTON OFFICE SUPPLY
ELBERTON GA
STD5F075.CMP



ELBERTON OFFICE SUPPLY
ELBERTON GA
STD5F076.CMP

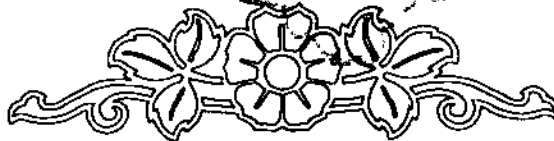

ELBERTON OFFICE SUPPLY
ELBERTON GA
STD5F077.CMP

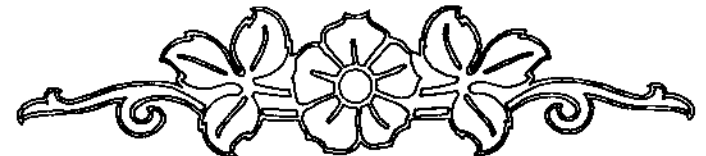

ELBERTON OFFICE SUPPLY
ELBERTON GA
STD5F078.CMP

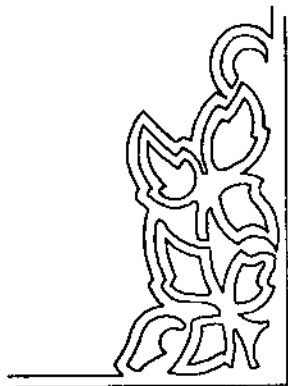

MILLER BROS. MONUMENT
IOWA CITY IA

STD5F079.CMP

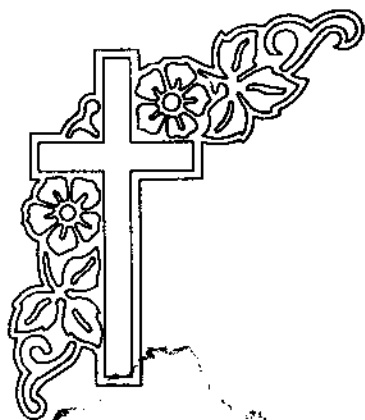

MILLER BROS. MONUMENT
IOWA CITY IA

STD5F080.CMP

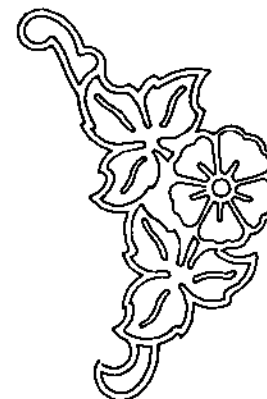

MILLER BROS. MONUMENT
IOWA CITY IA

STD5F081.CMP

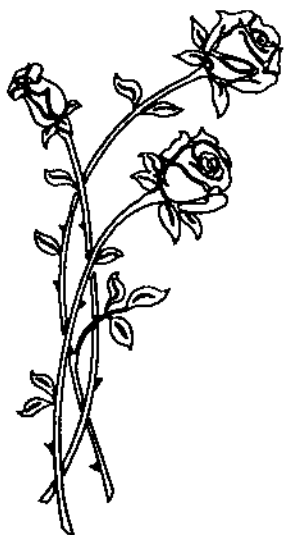

ST. CHARLES MEMORIAL WORKS
ST. CHARLES IL

STD5F082.CMP

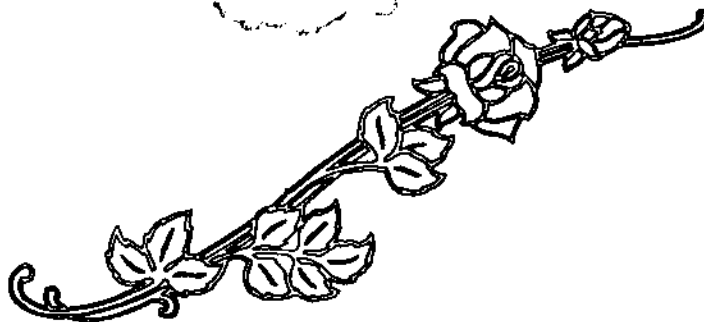

ROLLA MONUMENT CO.
ROLLA MO

STD5F083.CMP

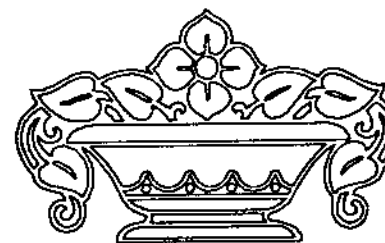

ROLLA MONUMENT CO.
ROLLA MO

STD5F084.CMP



CREATIVE MEMORIALS
MILTON ONTARIO CANADA

STD5F085.CMP



CREATIVE MEMORIALS
MILTON ONTARIO CANADA

STD5F088.CMP



CREATIVE MEMORIALS
MILTON ONTARIO CANADA

STD5F087.CMP



CREATIVE MEMORIALS
MILTON ONTARIO CANADA

STD5F088.CMP



CREATIVE MEMORIALS
MILTON ONTARIO CANADA

STD5F089.CMP



CREATIVE MEMORIALS
MILTON ONTARIO CANADA

STD5F090.CMP



CREATIVE MEMORIALS
MILTON ONTARIO CANADA

STD5F091.CMP



CREATIVE MEMORIALS
MILTON ONTARIO CANADA

STD5F092.CMP



MILACEK MONUMENT CO.
OMAHA NE

STD5F093.CMP



MILACEK MONUMENT CO.
OMAHA NE

STD5F094.CMP

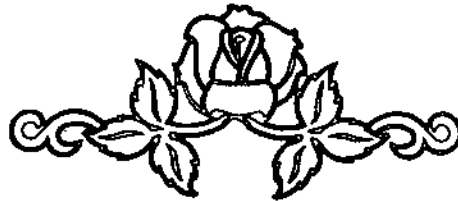

MILACEK MONUMENT CO.
OMAHA NE

STD5F095.CMP

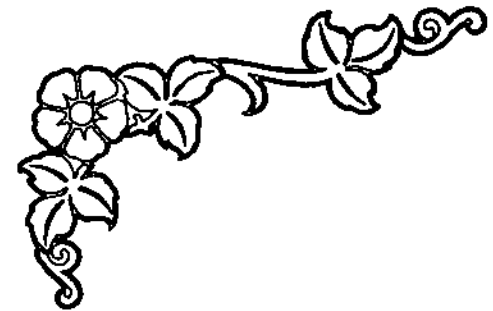

MILACEK MONUMENT CO.
OMAHA NE

STD5F096.CMP

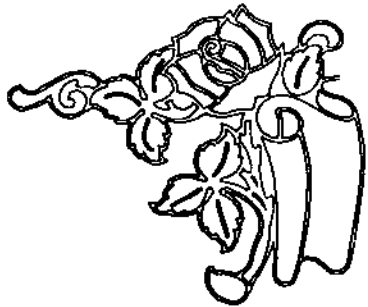

MILACEK MONUMENT CO.
OMAHA NE
STD5F097.CMP

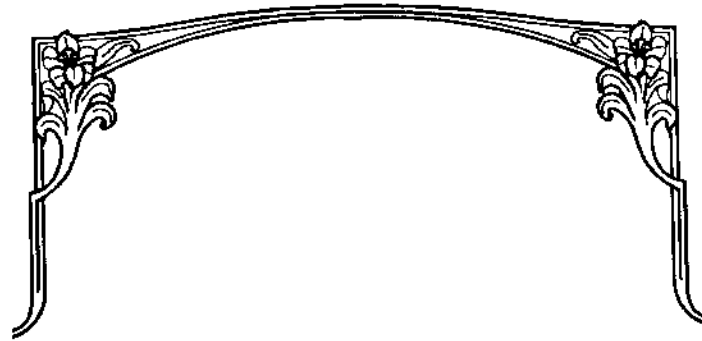

MILLIGAN MEMORIALS
COSHOCOTON OH
STD5F098.CMP

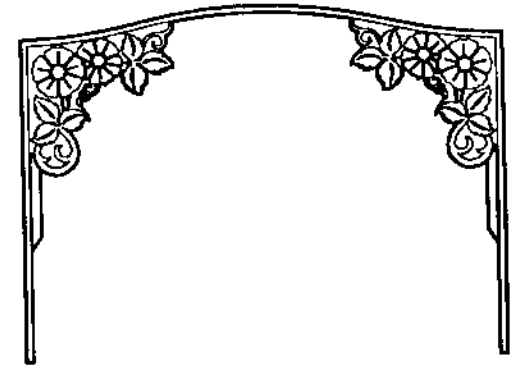

MILLIGAN MEMORIALS
COSHOCOTON OH
STD5F099.CMP

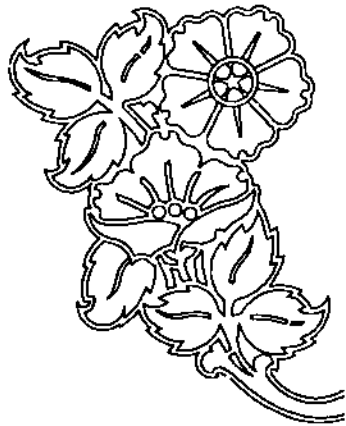

SHEVCHENKO MONUMENTAL WORKS
PERTH AMBOY NJ
STD5F100.CMP

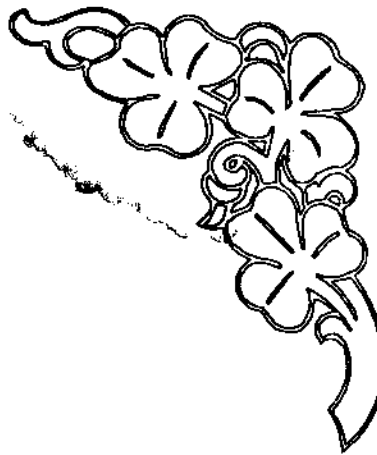

SHEVCHENKO MONUMENTAL WORKS
PERTH AMBOY NJ
STD5F101.CMP

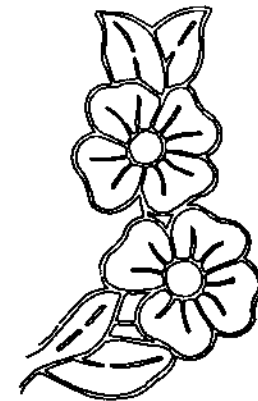

SHEVCHENKO MONUMENTAL WORKS
PERTH AMBOY NJ
STD5F102.CMP



SHEVCHENKO MONUMENTAL WORKS
PERTH AMBOY NJ

STD5F103.CMP

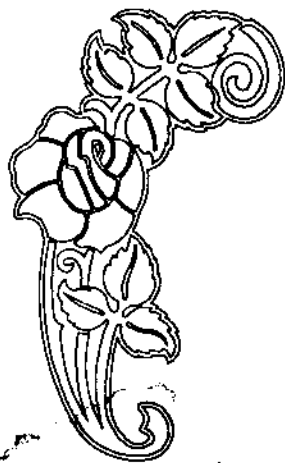

QUALITY-CUT MONUMENTAL DESIGNS
ELBERTON GA

STD5F104.CMP

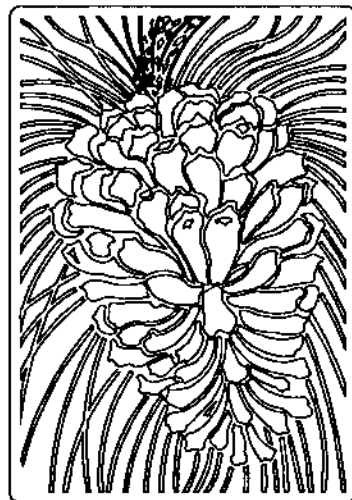

QUALITY-CUT MONUMENTAL DESIGNS
ELBERTON GA

STD5F105.CMP

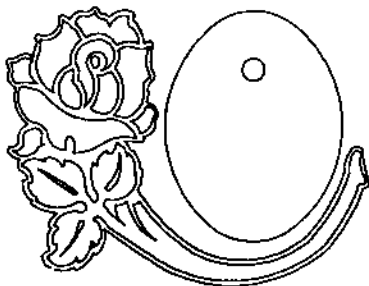

QUALITY-CUT MONUMENTAL DESIGNS
ELBERTON GA

STD5F106.CMP

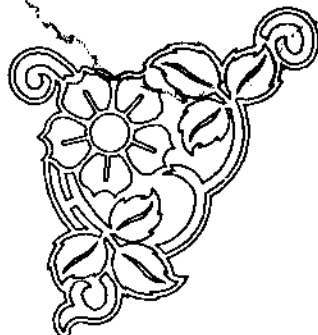

QUALITY-CUT MONUMENTAL DESIGNS
ELBERTON GA

STD5F107.CMP

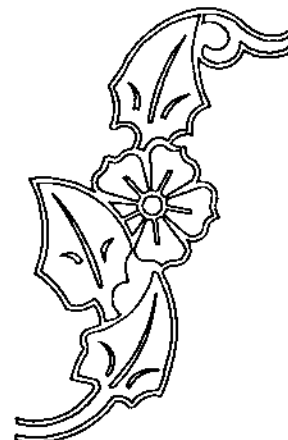

QUALITY-CUT MONUMENTAL DESIGNS
ELBERTON GA

STD5F108.CMP

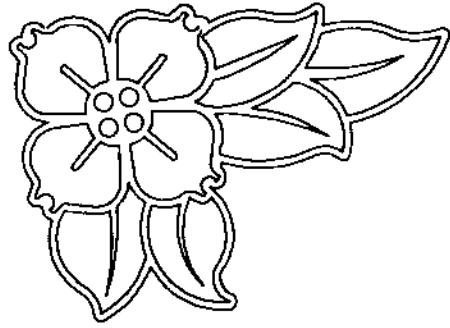

QUALITY-CUT MONUMENTAL DESIGNS
ELBERTON GA

STD5F109.CMP

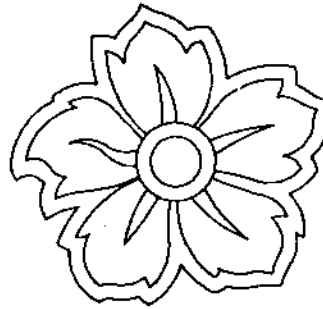

SEBASTIANO AIELLO MONUMENTS INC
MONTREAL QUEBEC CANADA

STD5F110.CMP



SEBASTIANO AIELLO MONUMENTS INC
MONTREAL QUEBEC CANADA

STD5F111.CMP

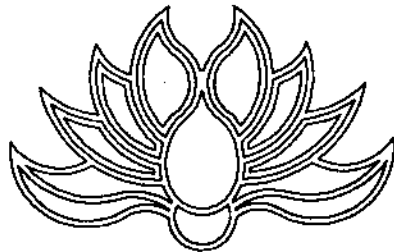

SEBASTIANO AIELLO MONUMENTS INC
MONTREAL QUEBEC CANADA

STD5F112.CMP



SEBASTIANO AIELLO MONUMENTS INC
MONTREAL QUEBEC CANADA

STD5F113.CMP

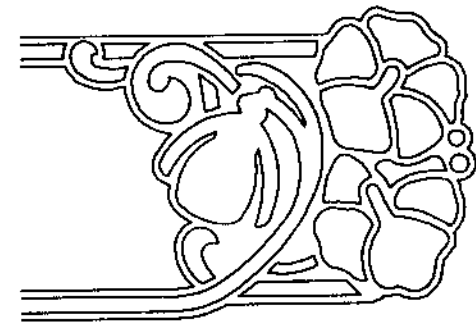

BOYCE MONUMENTAL SALES LTD
CARROLL IA

STD5F114.CMP



BAY MONUMENT CO
BAY CITY MI

STD5F115.CMP



BAY MONUMENT CO
BAY CITY MI

STD5F116.CMP



RMG STONE PRODUCTS
CASTLETON VT

STD5F117.CMP

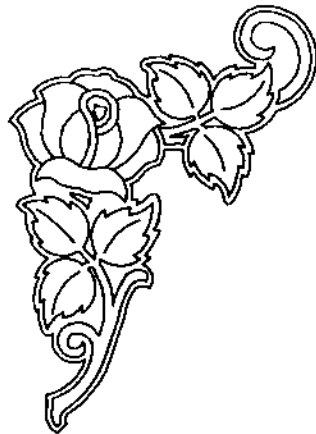

LONGSTRETH MEMORIALS
GALION OH

STD5F118.CMP



LONGSTRETH MEMORIALS
GALION OH

STD5F119.CMP

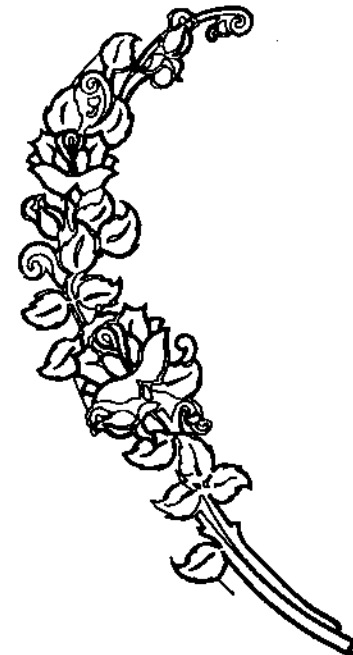

CROWN MONUMENT
WARREN OH

STD5F120.CMP



CROWN MONUMENT
WARREN OH

STD5F121.CMP



W.P. SIMMONS INC
MT. AIRY NC

STD5F122.CMP

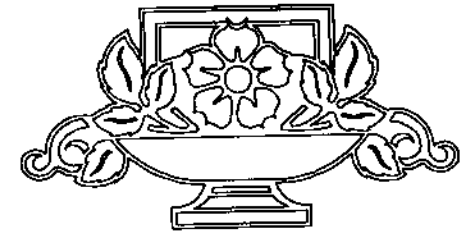

W.P. SIMMONS INC
MT. AIRY NC

STD5F123.CMP

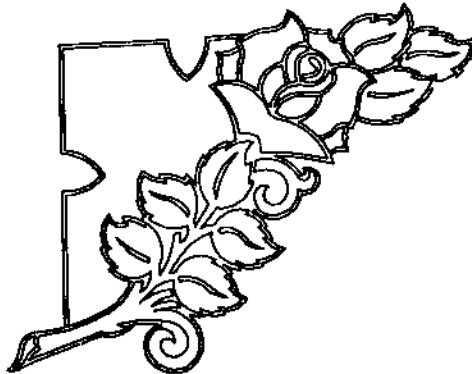

W.P. SIMMONS INC
MT. AIRY NC

STD5F124.CMP

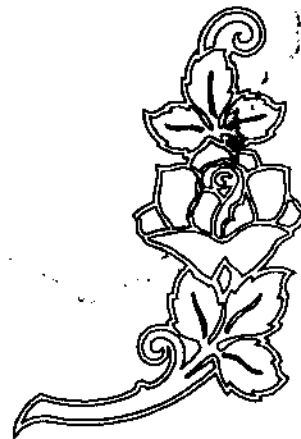

W.P. SIMMONS INC
MT. AIRY NC

STD5F125.CMP

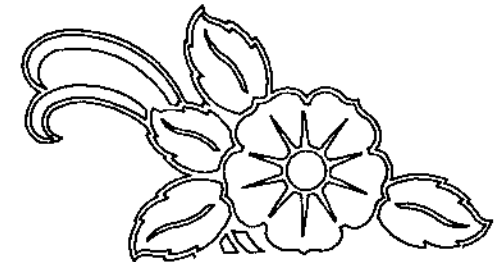

W.P. SIMMONS INC
MT. AIRY NC

STD5F126.CMP



W.P. SIMMONS. INC.
MT. AIRY NC

STD5F127.CMP

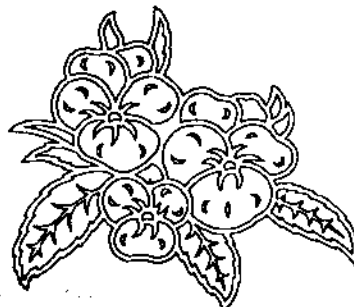

CAPITOL HILL MONUMENT
OKLAHOMA CITY OK

STD5F128.CMP

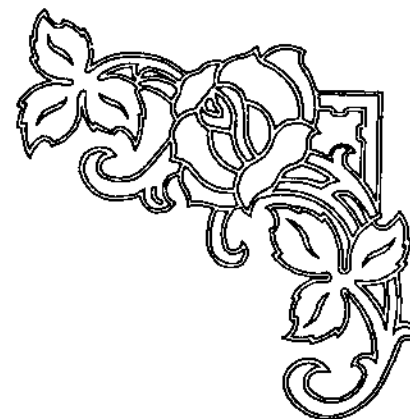

CAPITOL HILL MONUMENT
OKLAHOMA CITY OK

STD5F129.CMP



CAPITOL HILL MONUMENT
OKLAHOMA CITY OK

STD5F130.CMP

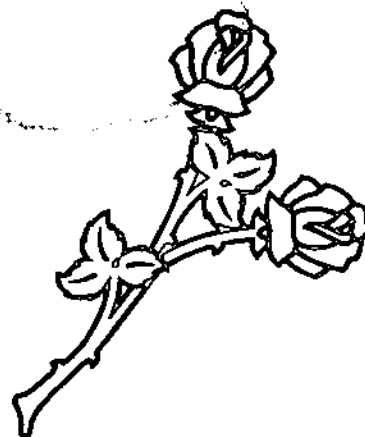

CAPITOL HILL MONUMENT
OKLAHOMA CITY OK

STD5F131.CMP



CAPITOL HILL MONUMENT
OKLAHOMA CITY OK

STD5F132.CMP

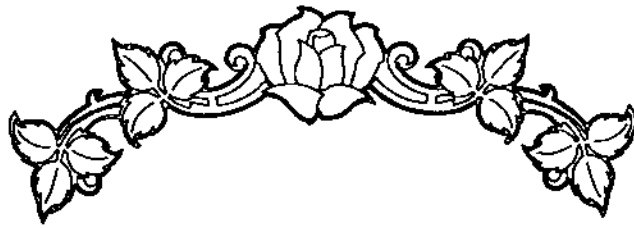

ALAN E. FRICKE MEMORIALS INC.
MEDFORD NY

STD5F133 .CMP

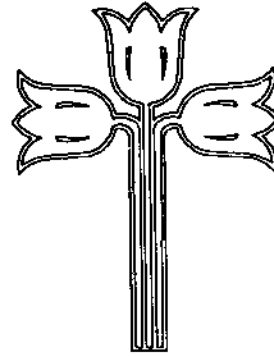

MILANO MONUMENTS
CLEVELAND OH

STD5F134 .CMP



MILANO MONUMENTS
CLEVELAND OH

STD5F135 .CMP

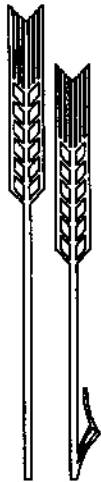

MILANO MONUMENTS
CLEVELAND OH

STD5F136 .CMP



MILANO MONUMENTS
CLEVELAND OH

STD5F137 .CMP



PEORIA MONUMENT CO
PEORIA IL

STD5F138 .CMP

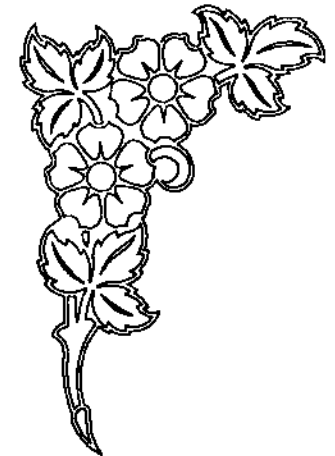

PEORIA MONUMENT CO
PEORIA IL

STD5F139 .CMP

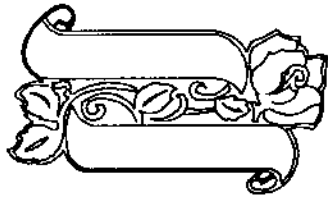

PEORIA MONUMENT CO
PEORIA IL

STD5F140.CMP



PEORIA MONUMENT CO
PEORIA IL

STD5F141.CMP

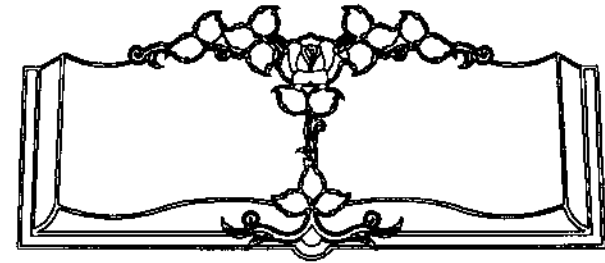

HAMILTON MEMORIALS
HAMILTON ONTARIO CANADA

STD5F142.CMP

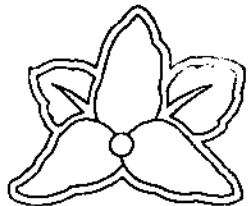

HAMILTON MEMORIALS
HAMILTON ONTARIO CANADA

STD5F143.CMP

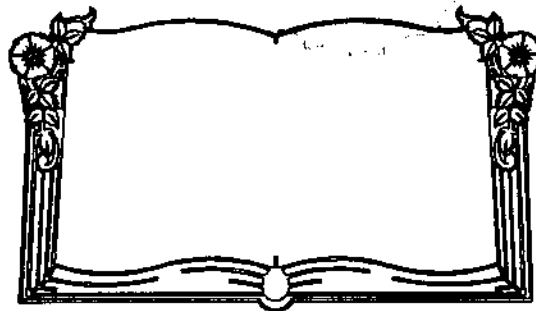

HAMILTON MEMORIALS
HAMILTON ONTARIO CANADA

STD5F144.CMP



McGARRY MEMORIALS
CHORLTON MANCHESTER UK

STD6F145.CMP



SOUTH BEND MONUMENT WORKS
SOUTH BEND IN

STD5F146.CMP



SOUTH BEND MONUMENT WORKS
SOUTH BEND IN

STD5F147.CMP



BARRE MEMORIALS
HYDE PARK NY

STD5F148.CMP

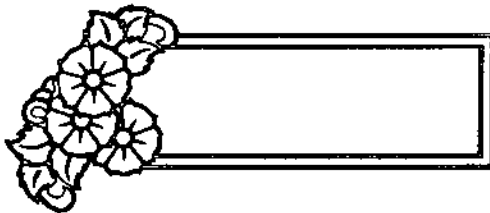

BARRE MEMORIALS
HYDE PARK NY

STD6F149.CMP

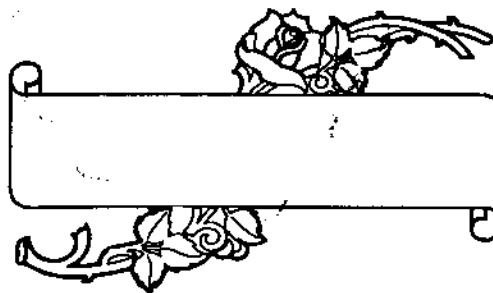

BARRE MEMORIALS
HYDE PARK NY

STD5F150.CMP

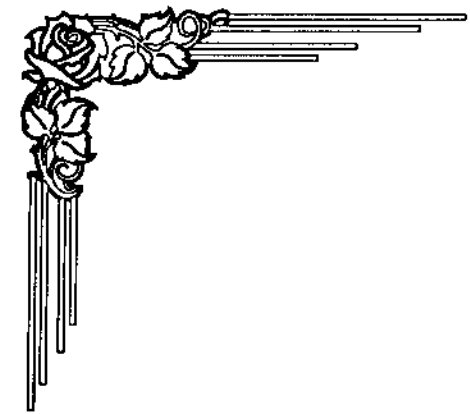

BARRE MEMORIALS
HYDE PARK NY

STD5F151.CMP



BEESELY MONUMENT CO
PROVO UT

STD5F152.CMP



BEESELY MONUMENT CO
PROVO UT

STD5F153.CMP

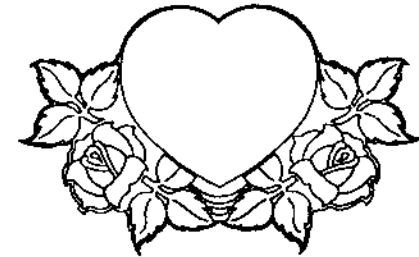

WOODSIDE GRANITE
ALBION NY

STD5F154.CMP

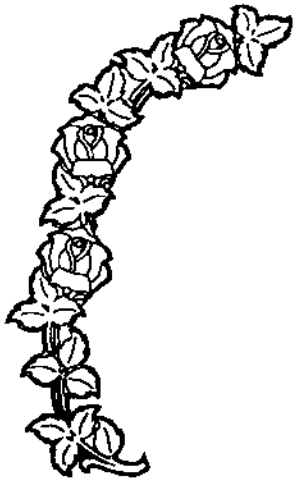

WOODSIDE GRANITE
ALBION NY

STD5F155.CMP



WOODSIDE GRANITE
ALBION NY

STD5F156.CMP



WOODSIDE GRANITE
ALBION NY

STD5F157.CMP



LEXINGTON GRANITE CO
LEXINGTON KY

STD5F158.CMP



BROWN MONUMENT
LOGAN UT

STD5F159.CMP

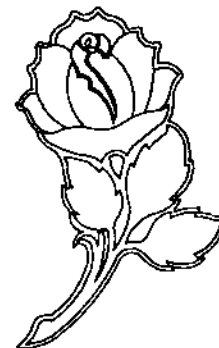

BROWN MONUMENT
LOGAN UT

STD5F160.CMP



BROWN MONUMENT
LOGAN UT

STD5F161.CMP

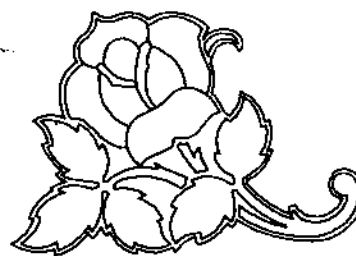

BROWN MONUMENT
LOGAN UT

STD5F162.CMP



BROWN MONUMENT
LOGAN UT

STD5F163.CMP

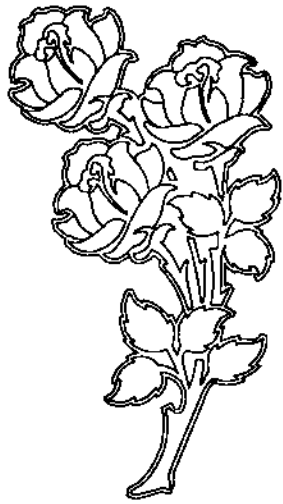

BROWN MONUMENT
LOGAN UT

STD5F164.CMP



MASTERCRAFT MEMORIALS
RICHMOND IN

STD5F165.CMP



GRANITE APPALACHES
LAC DROLET QUEBEC CANADA

STD5F166.CMP

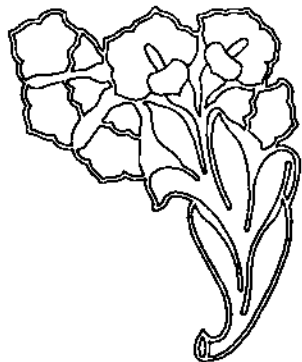

GRANITE APPALACHES
LAC DROLET QUEBEC CANADA

STD5F167.CMP

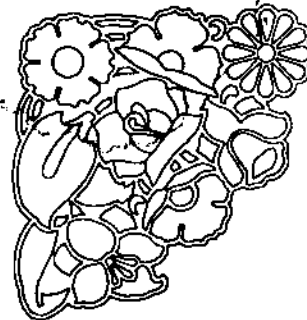

GRANITE APPALACHES
LAC DROLET QUEBEC CANADA

STD5F168.CMP

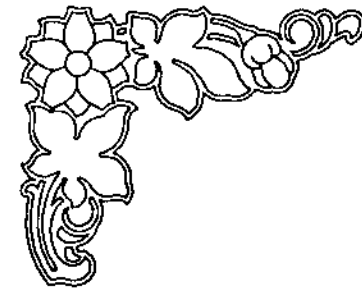

GRANITE APPALACHES
LAC DROLET QUEBEC CANADA

STD5F169.CMP

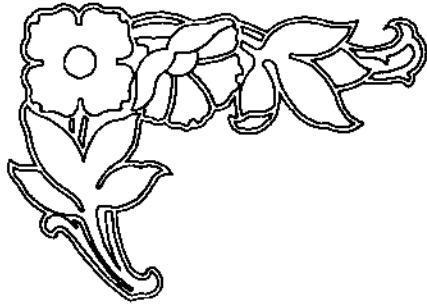

GRANITE APPALACHES
LAC DROLET QUEBEC CANADA

STD5F170.CMP

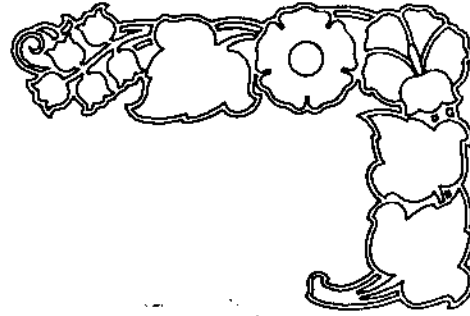

GRANITE APPALACHES
LAC DROLET QUEBEC CANADA

STD5F171.CMP

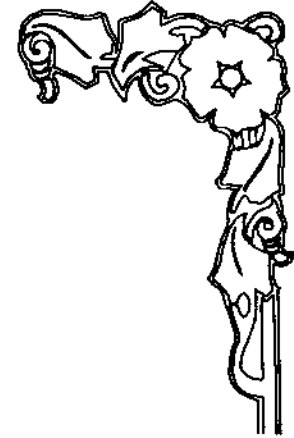

FOREST PARK MEMORIALS
HOUSTON TX

STD5F172.CMP

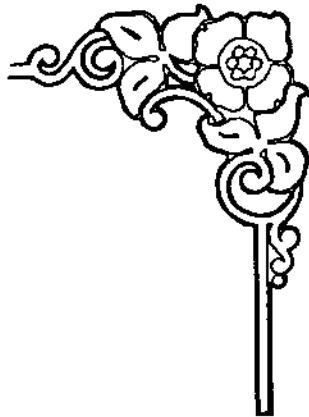

FOREST PARK MEMORIALS
HOUSTON TX

STD5F173.CMP



FOREST PARK MEMORIALS
HOUSTON TX

STD5F174.CMP

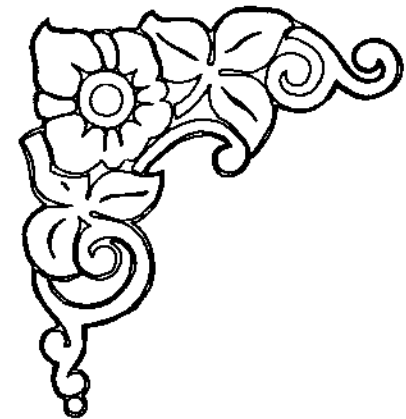

FOREST PARK MEMORIALS
HOUSTON TX

STD5F175.CMP

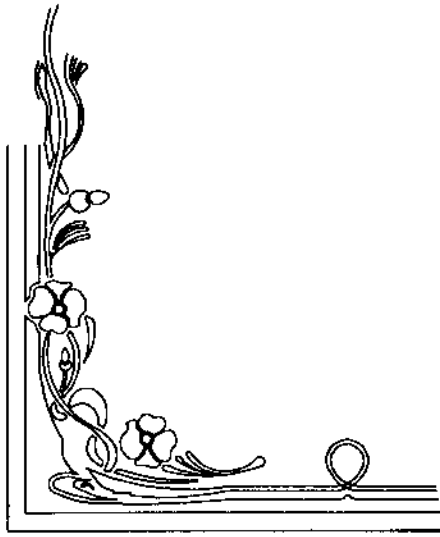

SCHAEFER MONUMENT CO
ST. LOUIS MO

STD5F176.CMP

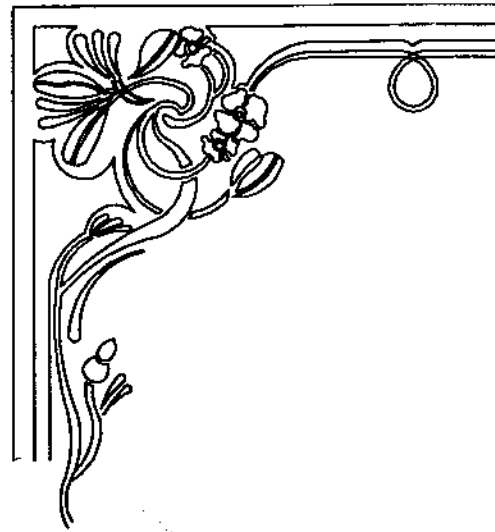

SCHAEFER MONUMENT CO
ST. LOUIS MO

STD5F177.CMP

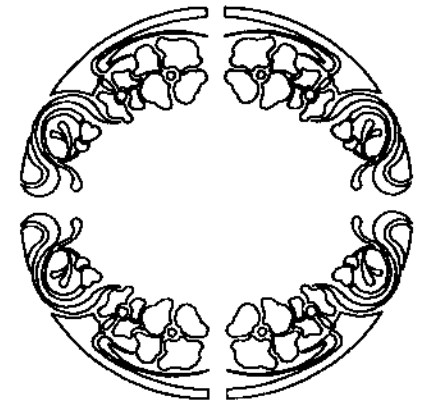

SCHAEFER MONUMENT CO
ST. LOUIS MO

STD5F178.CMP

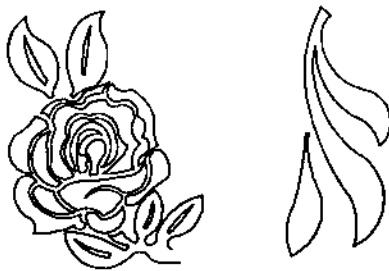

SCHAEFER MONUMENT CO
ST. LOUIS MO

STD5F179.CMP

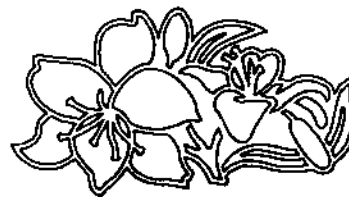

TROY MARBLE & GRANITE WORKS
TROY PA

STD5F180.CMP

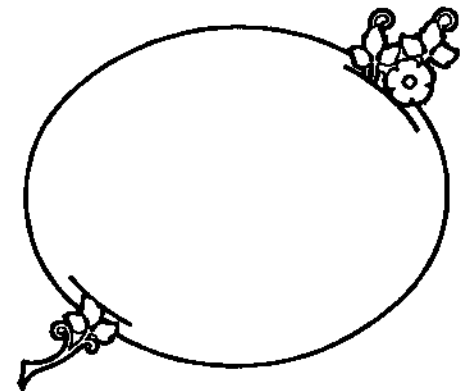

BAILEY MONUMENT CO
WAYCROSS GA

STD5F181.CMP

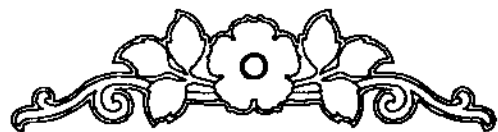

BAILEY MONUMENT CO
WAYCROSS GA

STD5F182.CMP

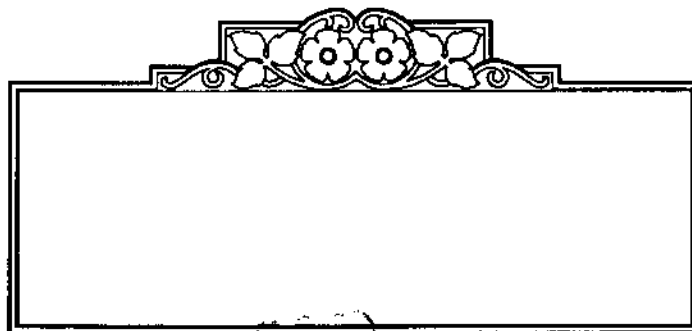

BAILEY MONUMENT CO
WAYCROSS GA

STD5F183.CMP

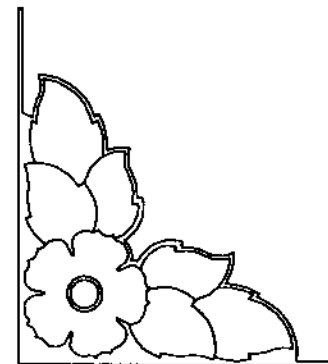

BAILEY MONUMENT CO
WAYCROSS GA

STD5F184.CMP

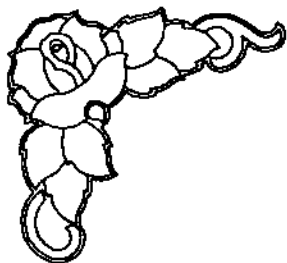

BAILEY MONUMENT CO
WAYCROSS GA

STDF5185.CMP

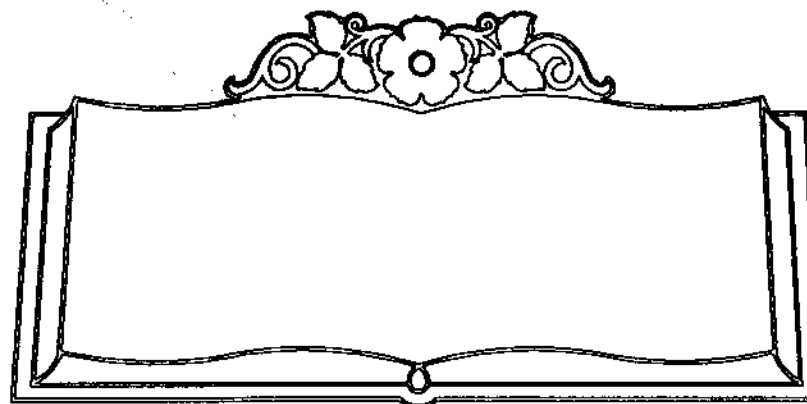

BAILEY MONUMENT CO
WAYCROSS GA

STD5F186.CMP

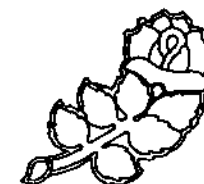

BAILEY MONUMENT CO
WAYCROSS GA

STD5F187.CMP



VISALIA GRANITE & MARBLE WORKS
VISALIA CA

STD5F194.CMP



VISALIA GRANITE & MARBLE WORKS
VISALIA CA

STD5F195.CMP

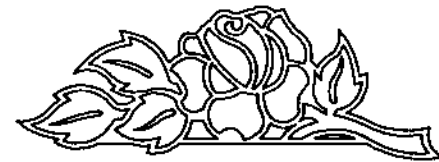

VISALIA GRANITE & MARBLE WORKS
VISALIA CA

STD5F196.CMP



VISALIA GRANITE & MARBLE WORKS
VISALIA CA

STD5F197.CMP

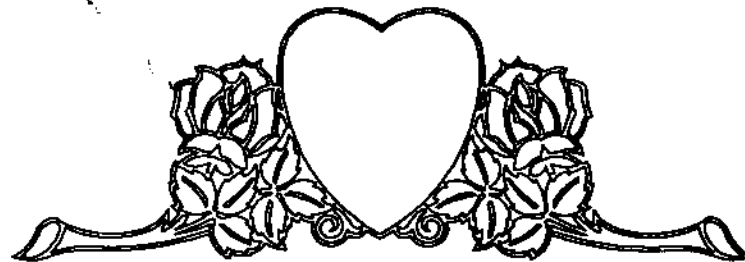

VISALIA GRANITE & MARBLE WORKS
VISALIA CA

STD5F198.CMP



VISALIA GRANITE & MARBLE WORKS
VISALIA CA

STD5F199.CMP



VISALIA GRANITE & MARBLE WORKS
VISALIA CA

STD5F200.CMP

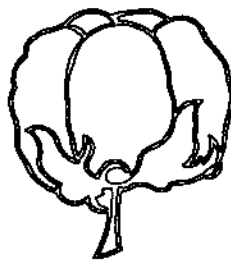

VISALIA GRANITE & MARBLE WORKS
VISALIA CA

STD5F201.CMP

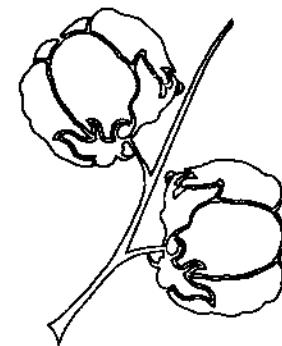

VISALIA GRANITE & MARBLE WORKS
VISALIA CA

STD5F202.CMP

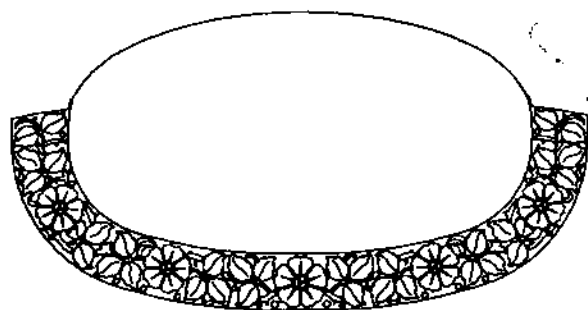

ROCK OF AGES CANADA
BEEBE QUEBEC CANADA

STD5F203.CMP

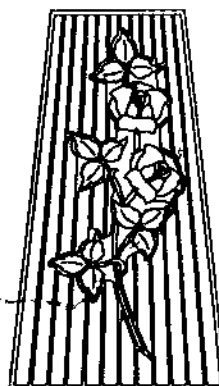

ROCK OF AGES CANADA
BEEBE QUEBEC CANADA

STD5F204.CMP



ROCK OF AGES CANADA
BEEBE QUEBEC CANADA

STD5F205.CMP

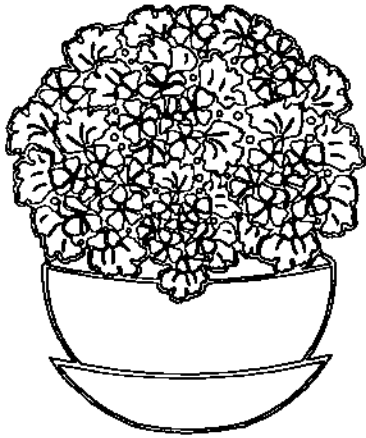

LANDMARK GRANITE CO
ELBERTON GA

STD5F206.CMP

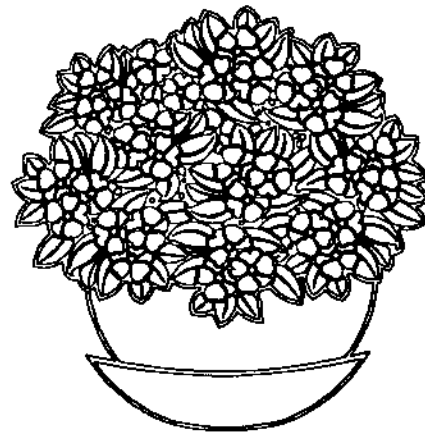

LANDMARK GRANITE CO
ELBERTON GA

STD5F207.CMP



LANDMARK GRANITE CO
ELBERTON GA

STD5F208.CMP



BRACOLONI CUSTOM MEMORIALS
TRENTON NJ

STD5F209.CMP



BRACOLONI CUSTOM MEMORIALS
TRENTON NJ

STD5F210.CMP



ART STONE CO
ROCK ISLAND IL

STD5F211.CMP



ART STONE CO
ROCK ISLAND IL

STD5F212.CMP

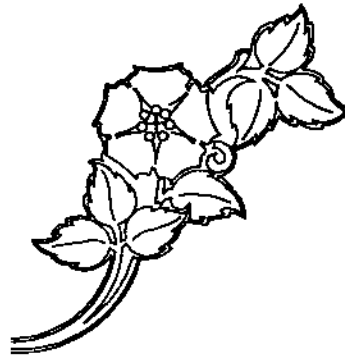

NICHOLSON MONUMENT CO
CLINTON OK

STD5F213.CMP



CARON GRANITE CO
PAWTUCKET RI

STD5F214.CMP

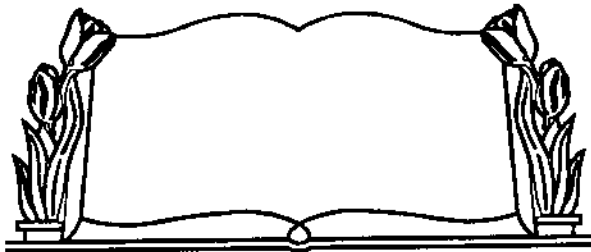

CARON GRANITE CO
PAWTUCKET RI

STD5F215.CMP

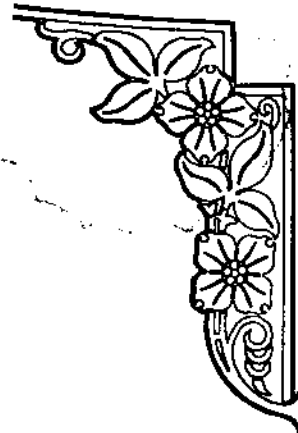

PHOENIXVILLE MEMORIAL WORKS
PHOENIXVILLE PA

STD5F216.CMP

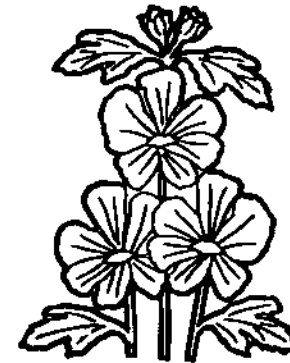

PHOENIXVILLE MEMORIAL WORKS
PHOENIXVILLE PA

STD5F217.CMP



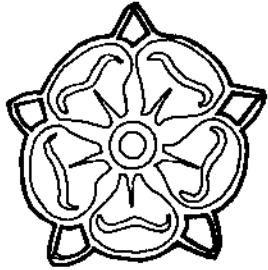

PHOENIXVILLE MEMORIAL WORKS
PHOENIXVILLE PA

STD5F218.CMP

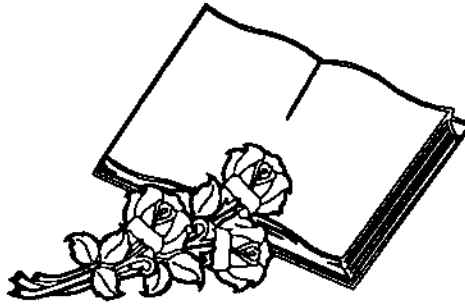

BREWER MONUMENT CO
PERRYVILLE MO

STD5F219.CMP

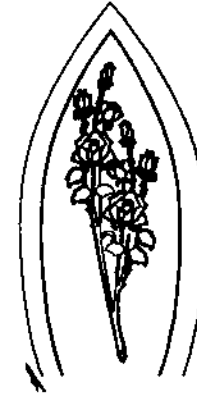

CHILDS & CHILDS GRANITE CO
ELBERTON GA

STD5F220.CMP

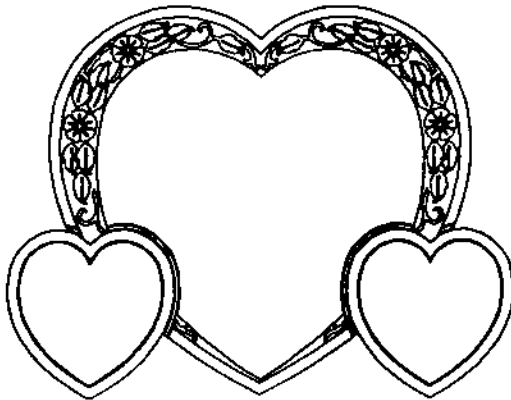

CHILDS & CHILDS GRANITE CO
ELBERTON GA

STF5F221.CMP



CHILDS & CHILDS GRANITE CO
ELBERTON GA

STD5F222.CMP

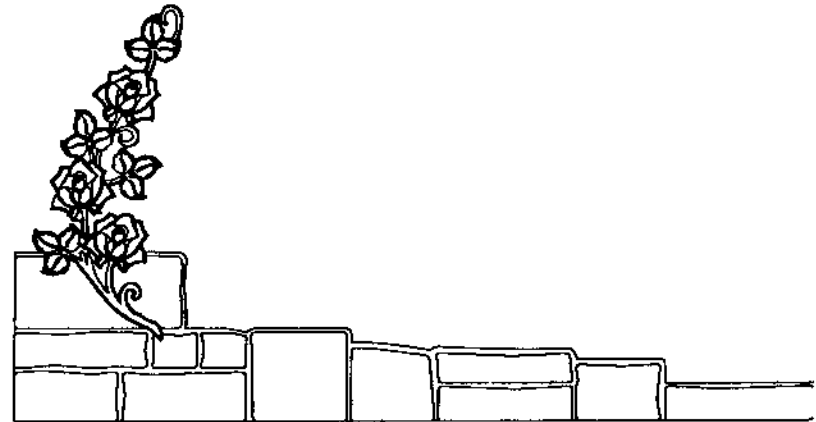

CHILDS & CHILDS GRANITE CO
ELBERTON GA

STD5F223.CMP

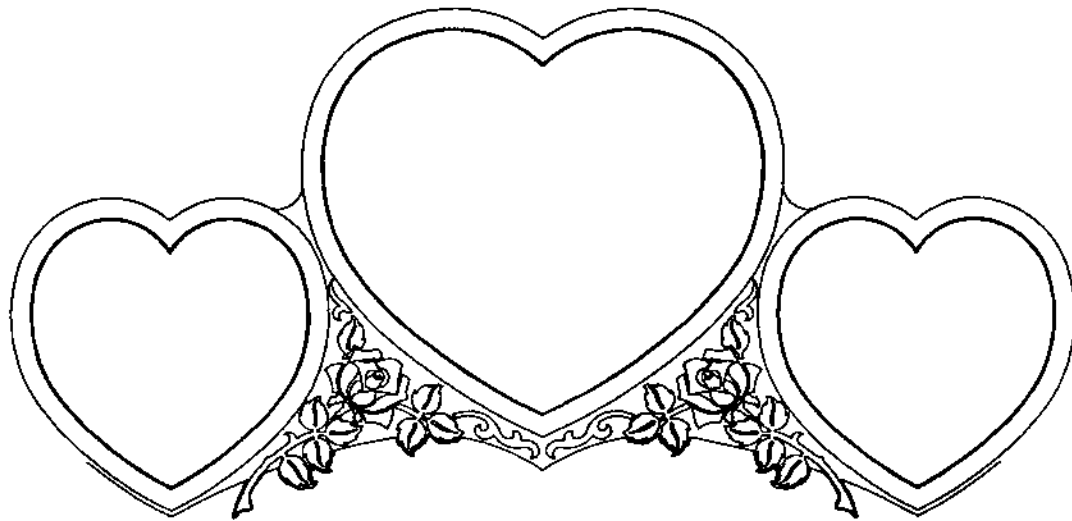

CHILDS & CHILDS GRANITE CO
ELBERTON GA
STD5F224.CMP

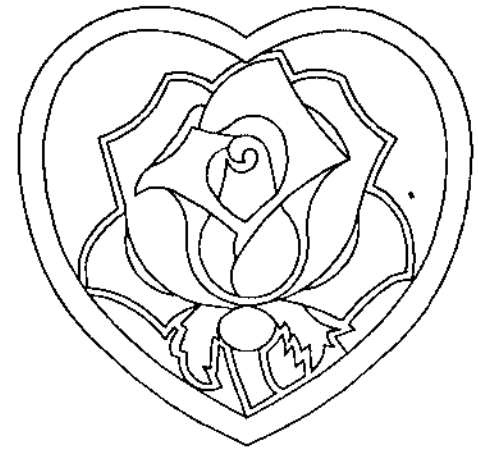

CHILDS & CHILDS GRANITE CO
ELBERTON GA
STD5F225.CMP

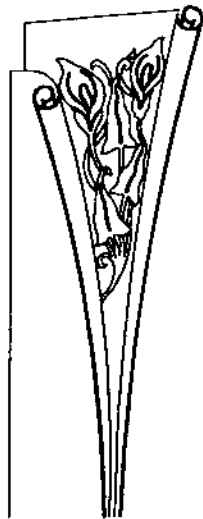

CHILDS & CHILDS GRANITE CO
ELBERTON GA
STD5F226.CMP

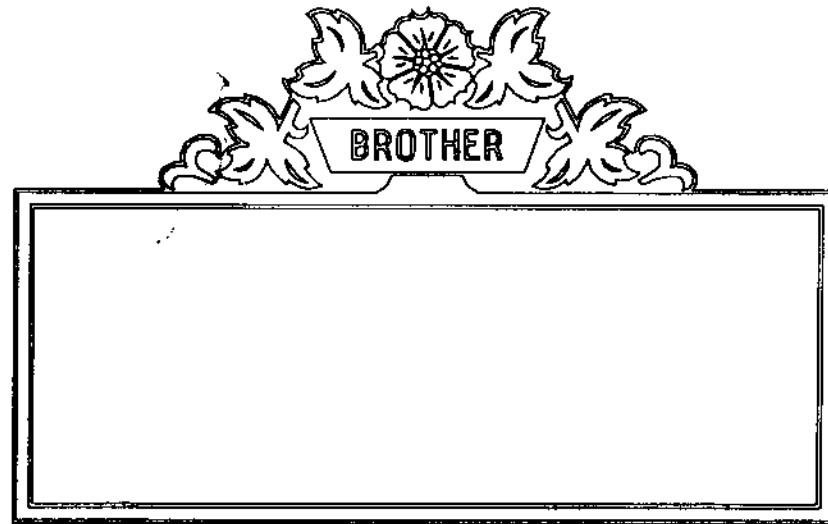

MCGEE MONUMENT CO
MORRILTON AR
STD5F227.CMP

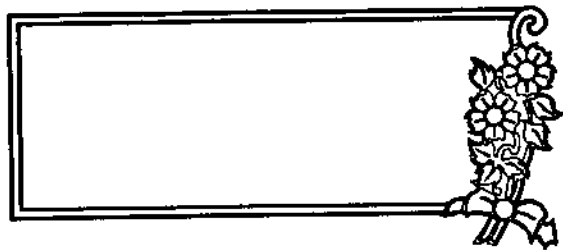

MC GEE MONUMENT CO
MORRILTON AR

STD5F228 .CMP

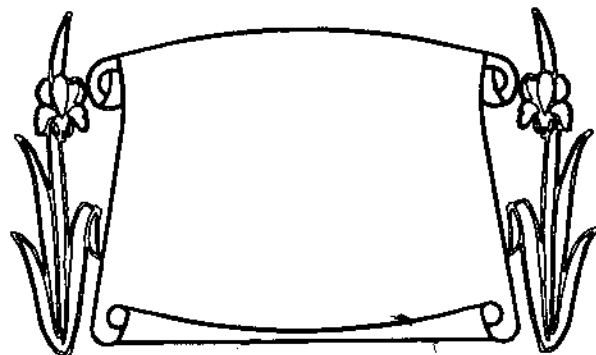

MC GEE MONUMENT CO
MORRILTON AR

STD5F229 .CMP

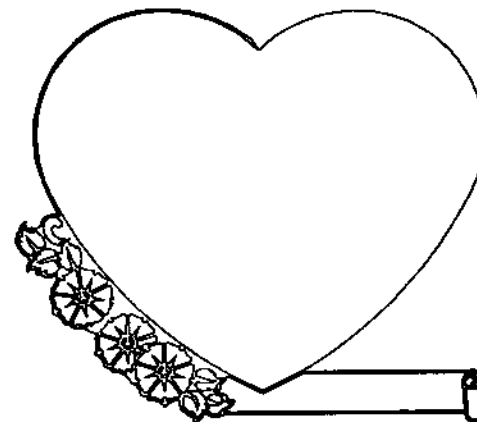

MC GEE MONUMENT CO
MORRILTON AR

STD5F230 .CMP

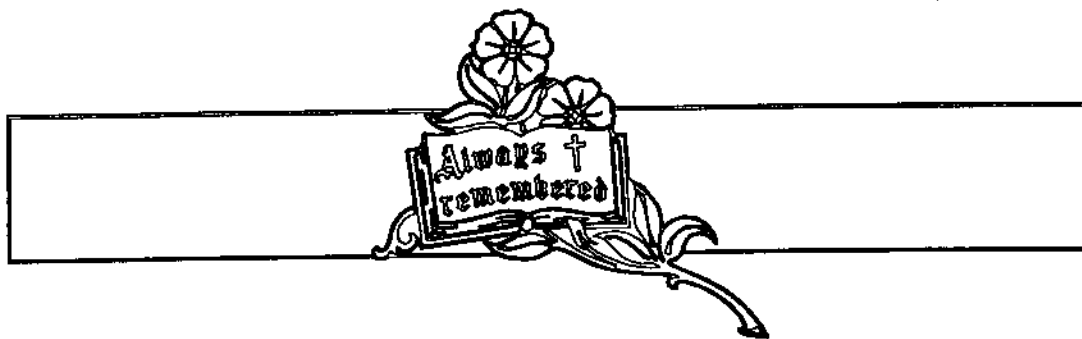

MC GEE MONUMENT CO
MORRILTON AR

STD5F231 .CMP

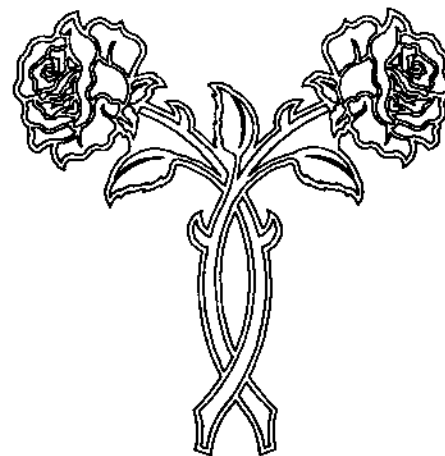

MC GEE MONUMENT CO
MORRILTON AR

STD5F232 .CMP



MC GEE MONUMENT CO
MORRILTON AR

STD5F233.CMP



MC GEE MONUMENT CO
MORRILTON AR

STD5F234.CMP



KEITH MONUMENT CO
BOWLING GREEN KY

STD5F235.CMP

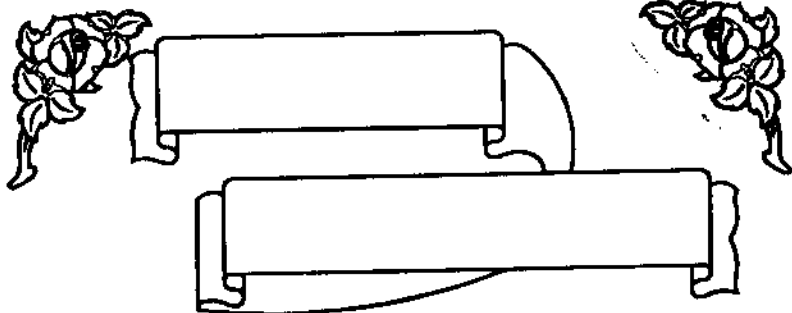

PEEBLES MONUMENT CO
PEEBLES OH

STD5F236.CMP

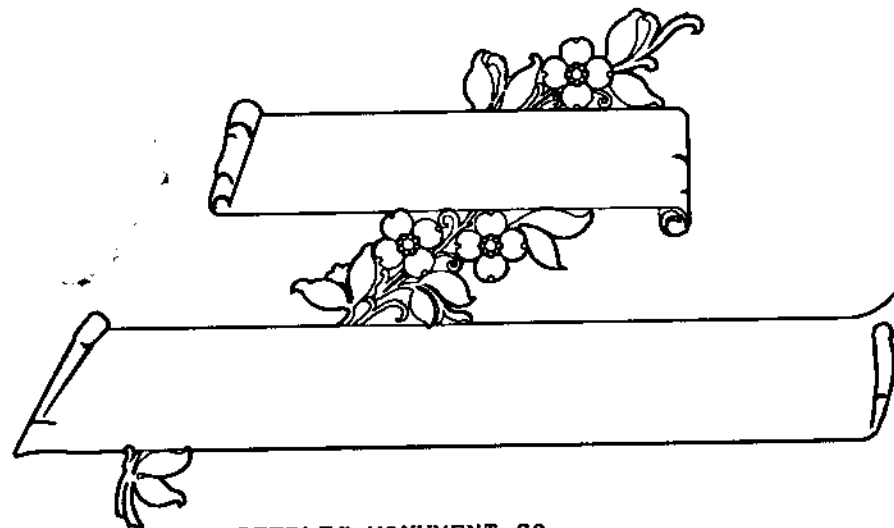

PEEBLES MONUMENT CO
PEEBLES OH

STD5F237.CMP



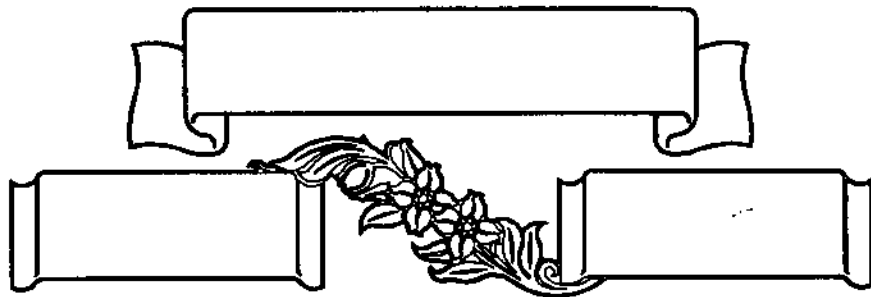

CHERRY VALLEY MEMORIALS
CHERRY VALLEY NY

STD5F238.CMP

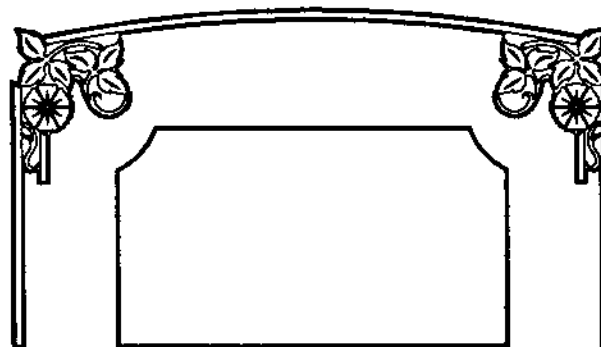

CHERRY VALLEY MEMORIALS
CHERRY VALLEY NY

STD5F239.CMP



CHERRY VALLEY MEMORIALS
CHERRY VALLEY NY

STD5F240.CMP

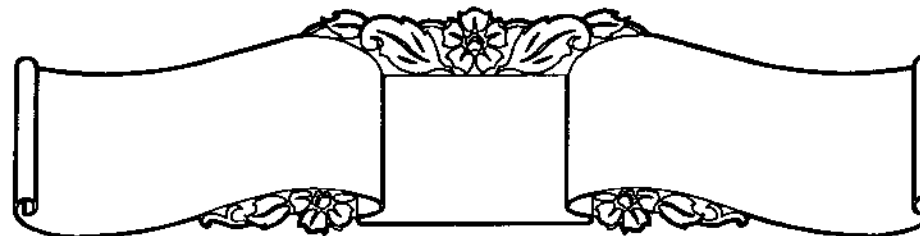

CHERRY VALLEY MEMORIALS
CHERRY VALLEY NY

STD5F241.CMP

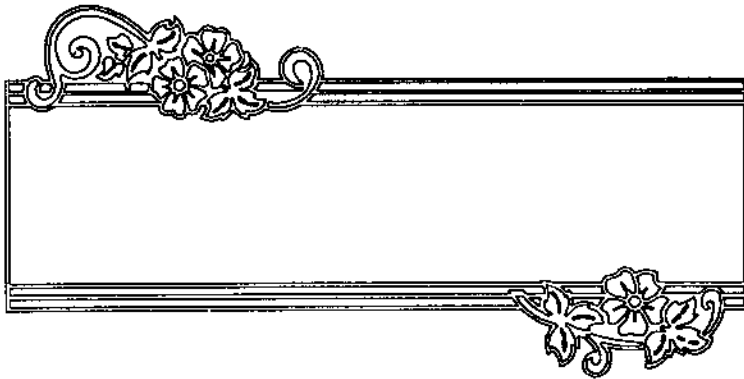

HENRY OLSON MEMORIALS
LOVES PARK IL

STD5F242.CMP

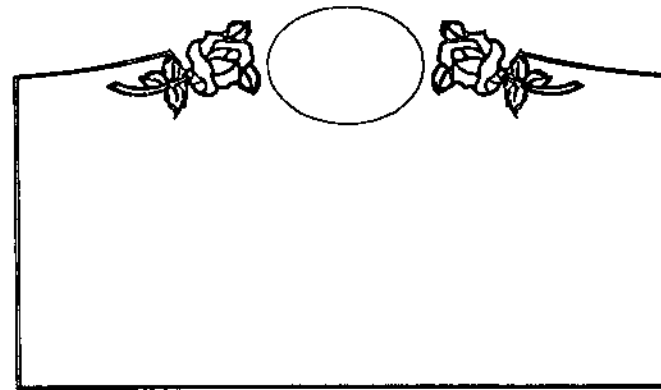

HENRY OLSON MEMORIALS
LOVES PARK IL

STD5F243.CMP



HENRY OLSON MEMORIALS
LOVES PARK IL

STD5F244.CMP

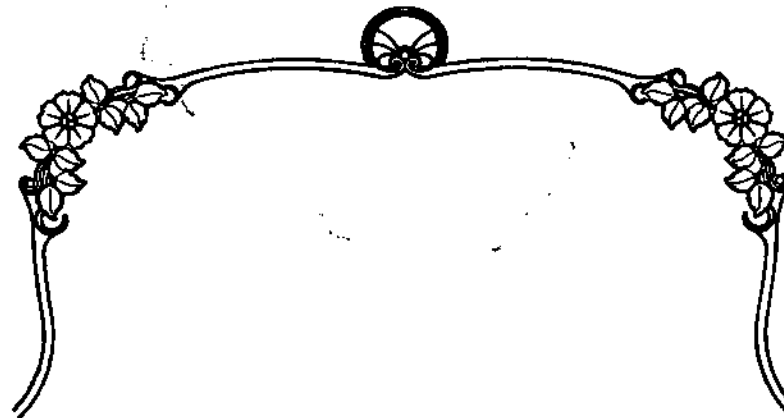

ROCK OF AGES CANADA
BEEBE QUEBEC CANADA

STD5F245.CMP



ROCK OF AGES CANADA
BEEBE QUEBEC CANADA

STD5F246.CMP

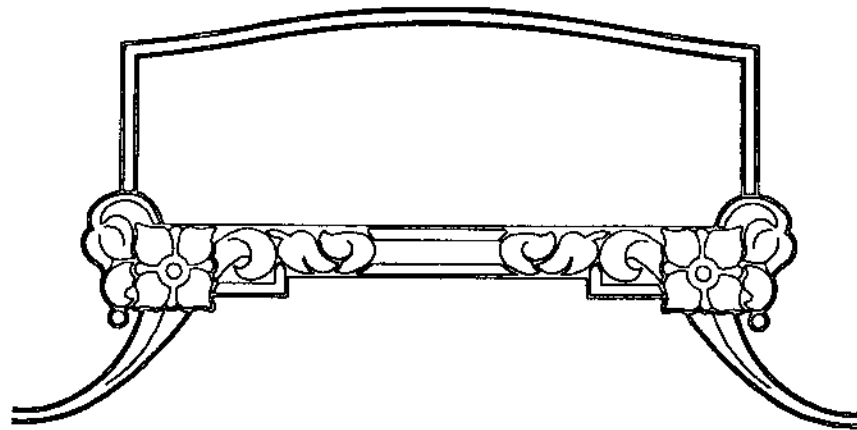

ROCK OF AGES CANADA
BEEBE QUEBEC CANADA

STD5F247.CMP

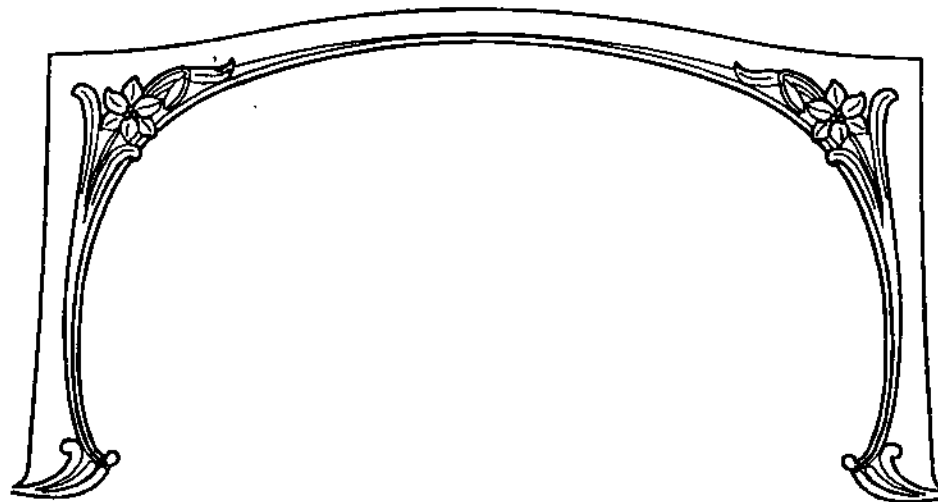

ROCK OF AGES CANADA
BEEBE QUEBEC CANADA

STD5F248.CMP



STAFFORD MONUMENTS
WHITBY ONTARIO
STD5J001.CMP



STAFFORD MONUMENTS
WHITBY ONTARIO
STD5J002.CMP



PIQUA GRANITE & MARBLE
PIQUA OH
STD5J003.CMP



NO TEARS PAST THE GATE

PIQUA GRANITE & MARBLE
PIQUA OH
STD5J004.CMP



SAXON GRANITE
ELBERTON GA

STD5J005.CMP

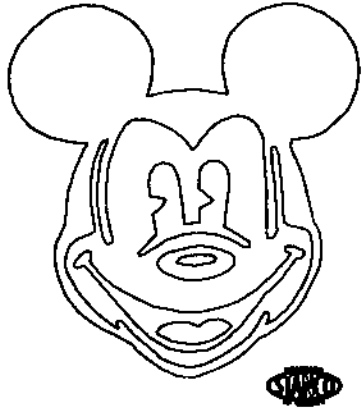

STANDARD GRANITE
ELBERTON GA

STD5J006 .CMP

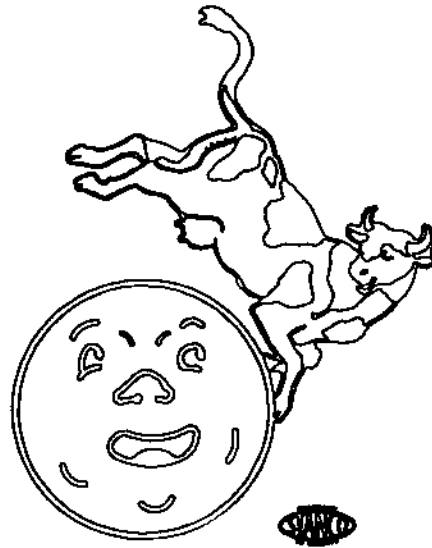

STANDARD GRANITE
ELBERTON GA

STD5J007 .CMP

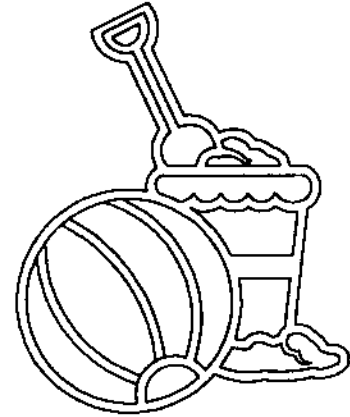

CENTRAL GRANITE CO.
ELBERTON GA

STD5J008 .CMP



N.C. MARBLE & GRANITE
CLINTON NC

STD5J009 .CMP

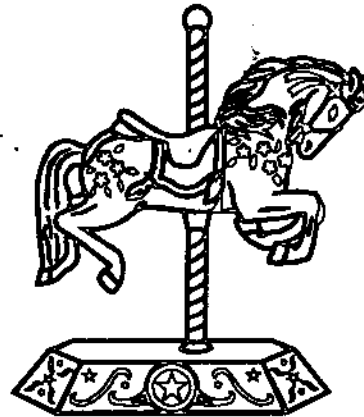

8 x 9
ARCHIE MON. & STONE
WATERTOWN WI

STD5J010 .CMP

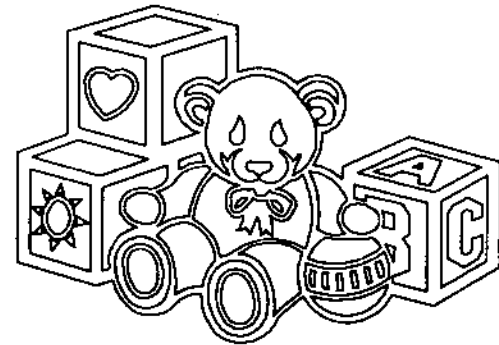

8.75 x 6.25
ARCHIE MON. & STONE
WATERTOWN WI

STD5J011 .CMP



4.625 x 7.75

ARCHIE MON. & STONE
WATERTOWN WI
STD5J012.CMP



DAWSON MONUMENT CO.
WINFIELD KS
STD5J013.CMP



DAWSON MONUMENT CO.
WINFIELD KS
STD5J014.CMP



DAWSON MONUMENT CO.
WINFIELD KS
STD5J015.CMP



DAWSON MONUMENT CO.
WINFIELD KS
STD5J016.CMP



DAWSON MONUMENT CO.
WINFIELD KS
STD5J017.CMP



DAWSON MONUMENT CO.
WINFIELD KS
STD5J018.CMP



BREWER MONUMENT CO.
PERRYVILLE MO
STD5J019.CMP

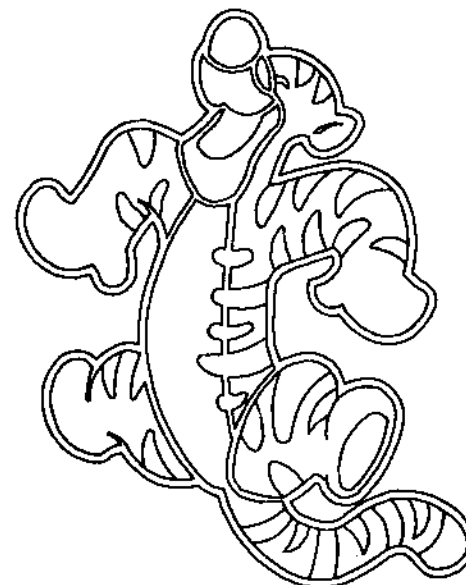

AMITE MARBLE & GRANITE
AMITE LA
STD5J020.CMP



EDWIN F. NICKOL
VERSAILLES OH
STD5J021.CMP

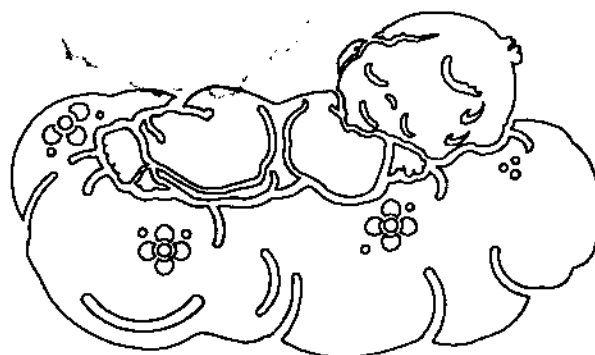

ERIE CITY MEMORIALS
ERIE PA
STD5J022.CMP



ERIE CITY MEMORIALS
ERIE PA
STD5J023.CMP



RUST-UNGER MONUMENTS
COLUMBUS IN STD5J024.CMP



RUST-UNGER MONUMENTS
COLUMBUS IN STD5J025.CMP

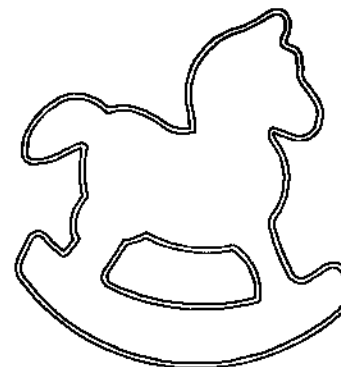

RUST-UNGER MONUMENTS
COLUMBUS IN STD5J026.CMP



land before time

SEAMON-POE MONUMENT CO.
SAN DIEGO CA STD5J027.CMP

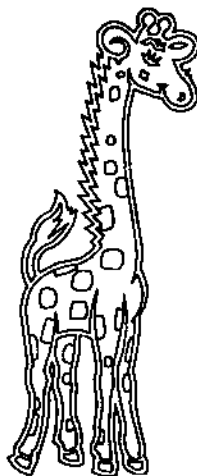

SEAMON-POE MONUMENT CO.
SAN DIEGO CA
STD5J028.CMP

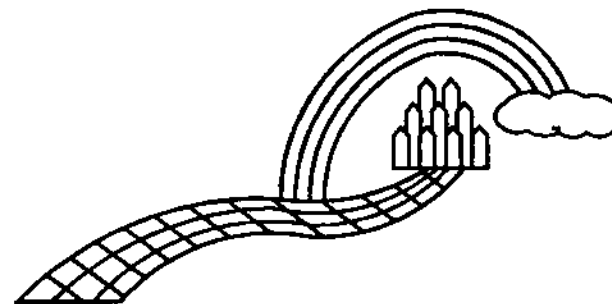

off to see the wizard

SEAMON-POE MONUMENT CO.
SAN DIEGO CA STD5J029.CMP



SEAMON-POE MONUMENT CO.
SAN DIEGO CA
STD5J030 .CMP

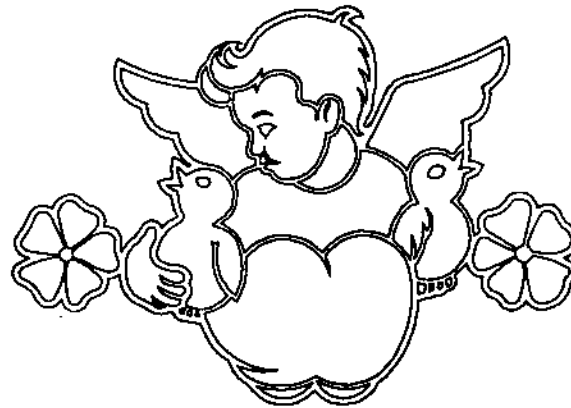

PALMER MONUMENT CO.
BROKEN BOW NE
STD5J031 .CMP



PALMER MONUMENT CO.
BROKEN BOW NE
STD5J032 .CMP



ST. CHARLES MEMORIAL WORKS
ST. CHARLES IL
STD5J033 .CMP

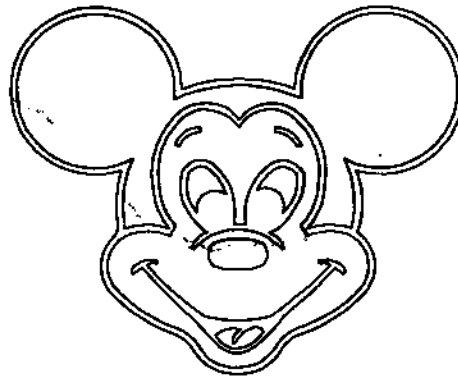

ST. CHARLES MEMORIAL WORKS
ST. CHARLES IL
STD5J034 .CMP



ST. CHARLES MEMORIAL WORKS
ST. CHARLES IL
STD5J035 .CMP





QUALITY-CUT MONUMENTAL DESIGNS
ELBERTON GA

STD5J036.CMP

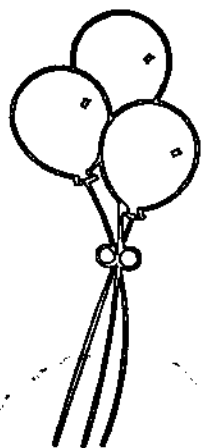

QUALITY-CUT MONUMENTAL DESIGNS
ELBERTON GA

STD5J037.CMP

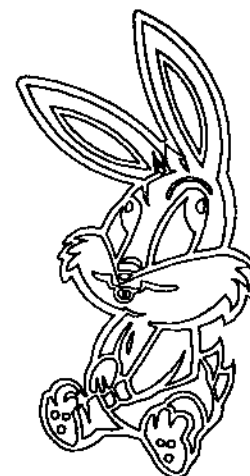

BAY MONUMENT CO
BAY CITY MI

STD5J038.CMP

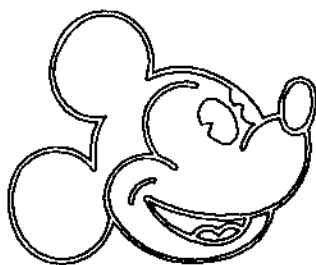

LONGSTRETH MEMORIALS
GALION OH

STD5J039.CMP



LONGSTRETH MEMORIALS
GALION OH

STD5J040.CMP



LONGSTRETH MEMORIALS
GALION OH

STD5J041.CMP



LONGSTRETH MEMORIALS
GALION OH

STD6J042.CMP

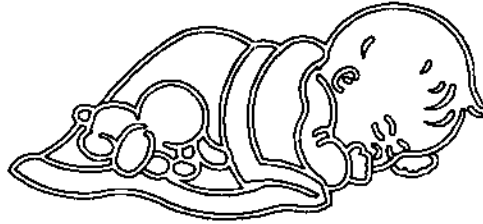

J.W. REYNOLDS MONUMENTS
VIENNA IL

STD5J043.CMP



HUTCH CUSTOM DESIGN
GROVETON NH

STD6J044.CMP



McGARRY MEMORIALS
CHORLTON MANCHESTER UK

STD5J045.CMP



McGARRY MEMORIALS
CHORLTON MANCHESTER UK

STD5J046.CMP



McGARRY MEMORIALS
CHORLTON MANCHESTER UK

STD5J047.CMP



McGARRY MEMORIALS
CHORLTON MANCHESTER UK

STD5J048 .CMP



McGARRY MEMORIALS
CHORLTON MANCHESTER UK

STD5J049 .CMP



SOUTH BEND MONUMENT WORKS
SOUTH BEND IN

STD5J050 .CMP

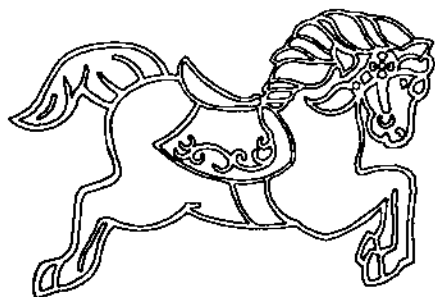

LEXINGTON GRANITE CO
LEXINGTON KY

STD5J051 .CMP

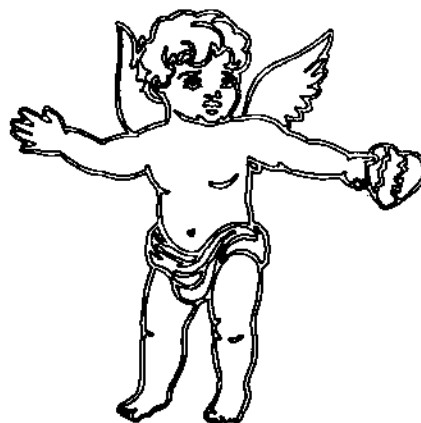

LEXINGTON GRANITE CO
LEXINGTON KY

STD5J052 .CMP



MASTERCRAFT MEMORIALS
RICHMOND IN

STD5J053 .CMP

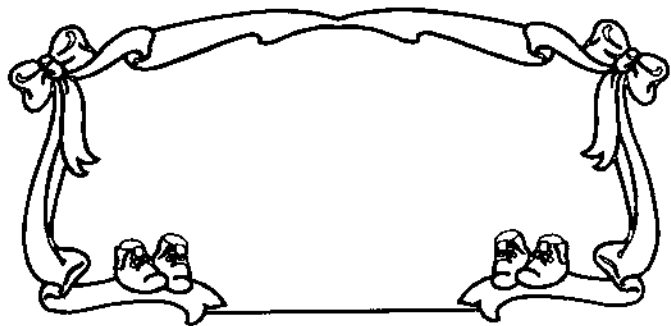

TROY MARBLE & GRANITE WORKS
TROY PA

STD5J054.CMP



L. J. SERVICES
CHERRY VALLEY NY

STD5J055.CMP



L. J. SERVICES
CHERRY VALLEY NY

STD5J056.CMP



L. J. SERVICES
CHERRY VALLEY NY

STD5J057.CMP



L. J. SERVICES
CHERRY VALLEY NY

STD5J058.CMP

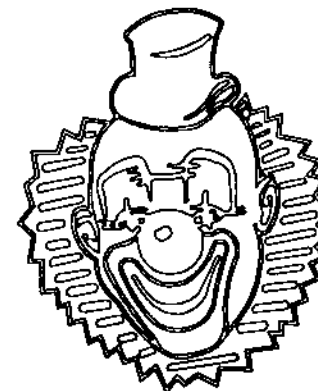

LANDMARK GRANITE CO
ELBERTON GA

STD5J059.CMP

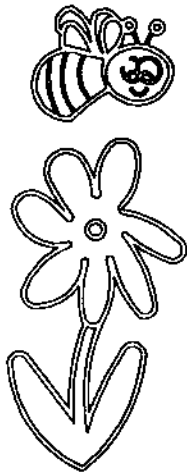

RINKER & FRYE MEMORIALS
MT. JACKSON VA

STD5J060.CMP



RINKER & FRYE MEMORIALS
MT. JACKSON VA

STD5J061.CMP



RINKER & FRYE MEMORIALS
MT. JACKSON VA

STD5J062.CMP

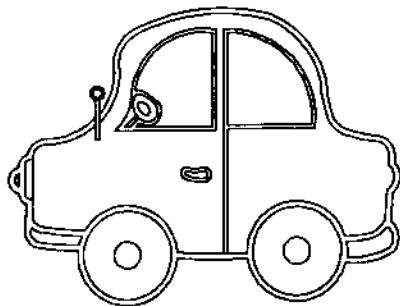

RINKER & FRYE MEMORIALS
MT. JACKSON VA

STD5J063.CMP

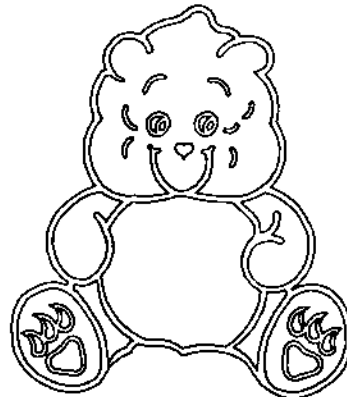

RINKER & FRYE MEMORIALS
MT. JACKSON VA

STD5J064.CMP

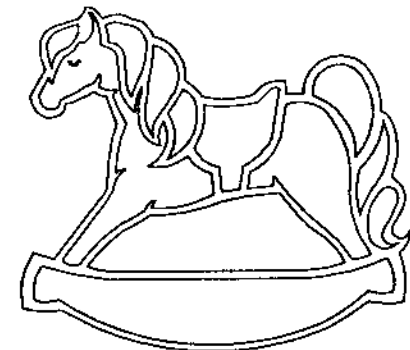

ART STONE CO
ROCK ISLAND IL

STD5J065.CMP

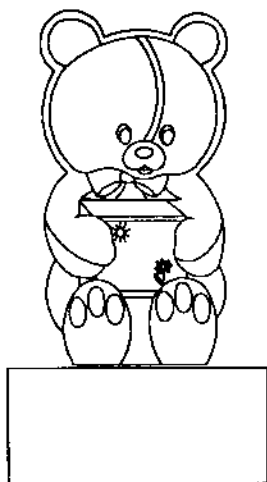

ART STONE CO
ROCK ISLAND IL

STD5J066.CMP



CARON GRANITE CO
PAWTUCKET RI

STD5J067.CMP

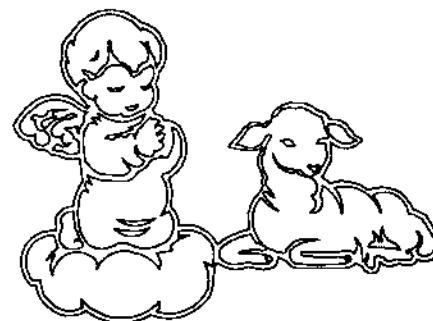

PLOUFF'S MONUMENT CO
ST. ALBANS VT

STD5J068.CMP

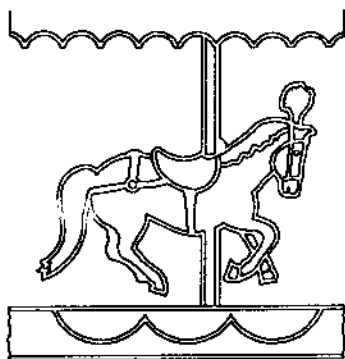

PEEBLES MONUMENT CO
PEEBLES OH

STD5J069.CMP

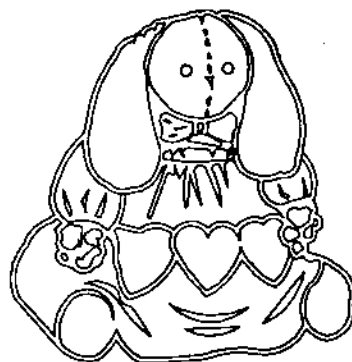

PEEBLES MONUMENT CO
PEEBLES OH

STD5J070.CMP

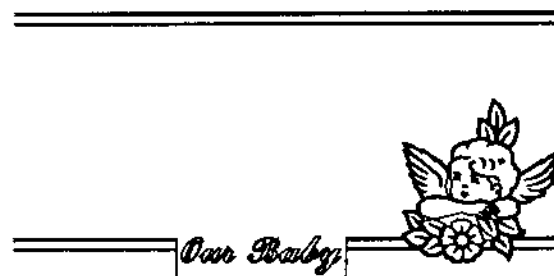

PEEBLES MONUMENT CO
PEEBLES OH

STD5J071.CMP



ADAMS MEMORIALS
CHARLESTON IL

STD5J072.CMP



WEARLY MONUMENTS
MUNCIE IN

STD5J073.CMP

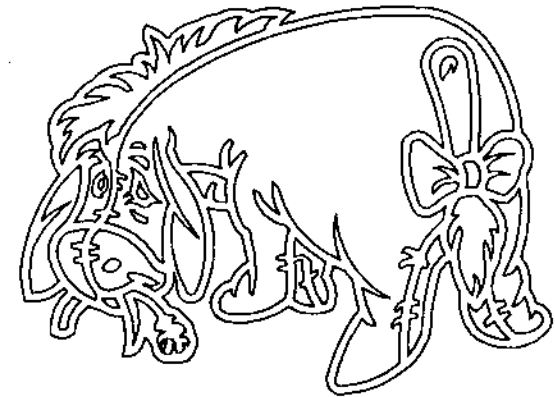

WEARLY MONUMENTS
MUNCIE IN

STD5J074.CMP

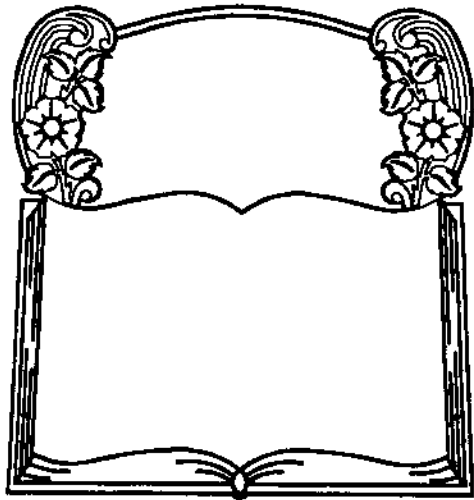

STAFFORD MONUMENTS
WHITBY ONTARIO STD5M001.CMP

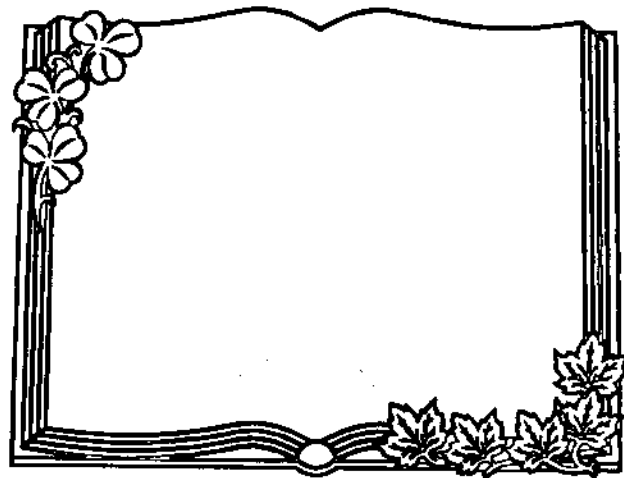

STAFFORD MONUMENTS
WHITBY ONTARIO STD5M002.CMP

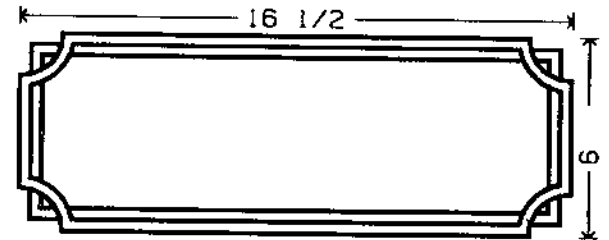

TULSA MONUMENT CO.
TULSA OK STD5M003.CMP

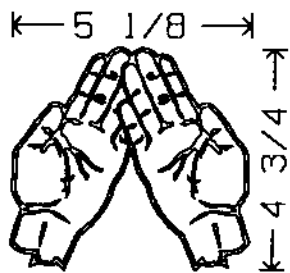

TULSA MONUMENT CO.
TULSA OK STD5M004.CMP



TULSA MONUMENT CO.
TULSA OK STD5M005.CMP

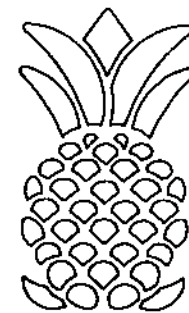

CAMDEN MONUMENT CO.
CAMDEN AR STD5M006.CMP



SANDZIMIER MEMORIALS
SCOTTDALE PA
STD5M007.CMP

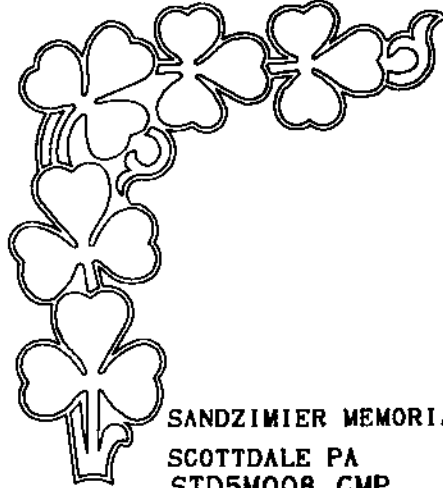

SANDZIMIER MEMORIALS
SCOTTDALE PA
STD5M008.CMP

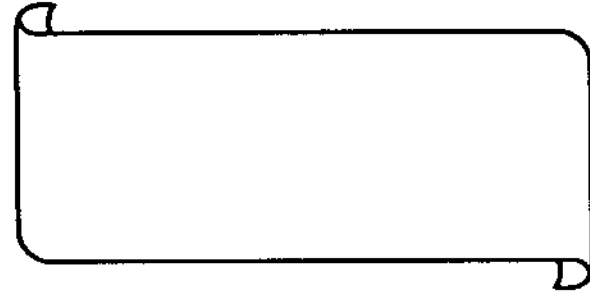

SANDZIMIER MEMORIALS
SCOTTDALE PA STD5M009.CMP



SANDZIMIER MEMORIALS
SCOTTDALE PA
STD5M010.CMP



SANDZIMIER MEMORIALS STD5M011.CMP
SCOTTDALE PA



SANDZIMIER MEMORIALS
SCOTTDALE PA
STD5M012.CMP

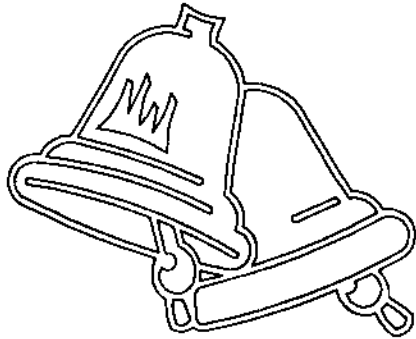

PIQUA GRANITE & MARBLE
PIQUA OH STD5M013.CMP

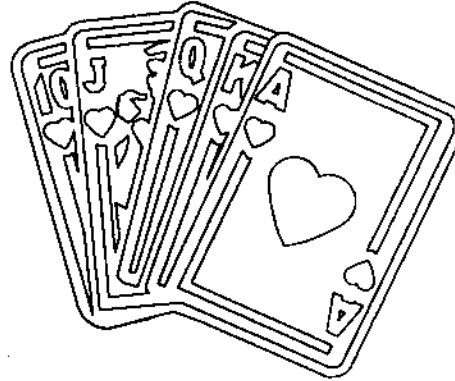

PIQUA GRANITE & MARBLE
PIQUA OH STD5M014.CMP

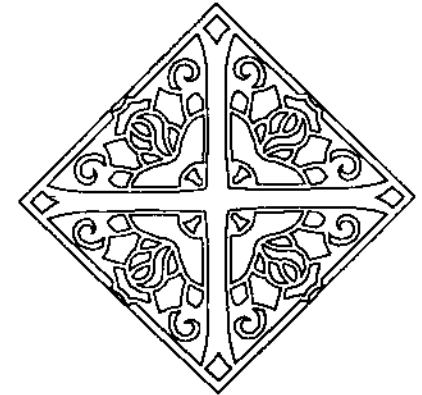

PIQUA GRANITE & MARBLE
PIQUA OH STD5M015.CMP

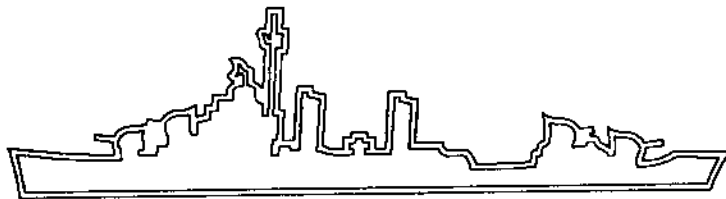

PIQUA GRANITE & MARBLE
PIQUA OH STD5M016.CMP

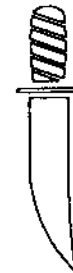

EVERGREEN MEMORIALS
CALGARY ALBERTA
STD5M017.CMP

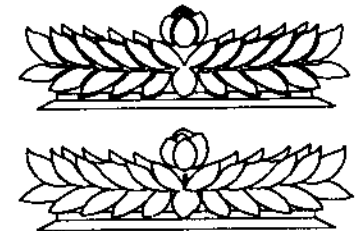

EVERGREEN MEMORIALS
CALGARY ALBERTA
STD5M018.CMP

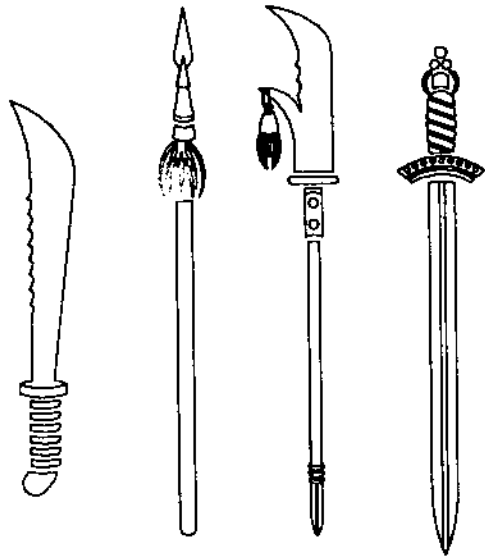

EVERGREEN MEMORIALS
CALGARY ALBERTA
STD5M019 .CMP

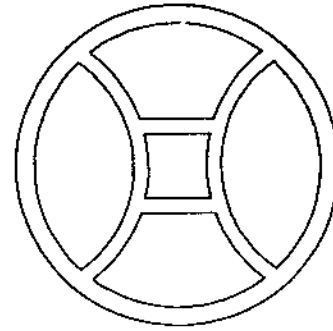

EVERGREEN MEMORIALS
CALGARY ALBERTA
STD5M020 .CMP

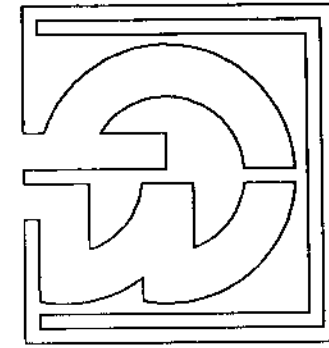

EVERGREEN MEMORIALS
CALGARY ALBERTA
STD5M021 .CMP

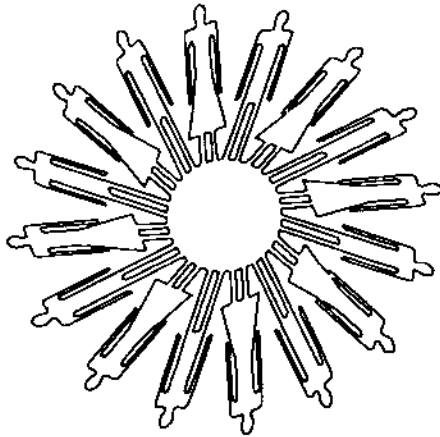

EVERGREEN MEMORIALS
CALGARY ALBERTA
STD5M022 .CMP

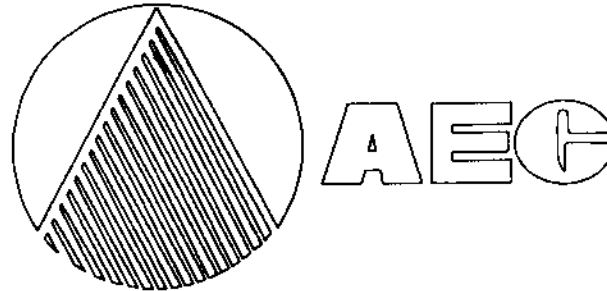

EVERGREEN MEMORIALS
CALGARY ALBERTA
STD5M023 .CMP

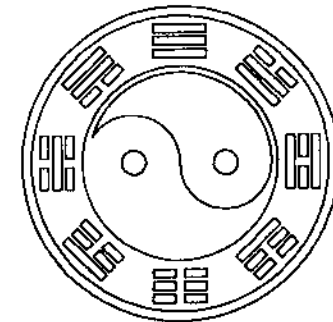

EVERGREEN MEMORIALS
CALGARY ALBERTA
STD5M024 .CMP





EAGLE BEND
BIGFORK, MONTANA
MAY 19, 1998

GROUP 1	FRONT	BACK	TOTAL
JOHN	48	48	96
LEN	80	80	160
MURRY	80	80	160
BRIAN	88	88	176
GROUP 2			
CARL	80	48	98
DALE	80	81	161
BRENT	80	81	161
DUKE	88	82	170

EVERGREEN MEMORIALS
CALGARY ALBERTA

STD5M025.CMP



EVERGREEN MEMORIALS
CALGARY ALBERTA

STD5M026.CMP



SAXON GRANITE
ELBERTON GA

STD5M027.CMP

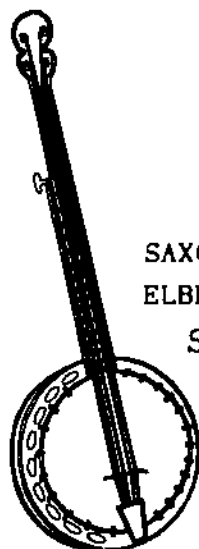

SAXON GRANITE
ELBERTON GA

STD5M028.CMP



STANDARD GRANITE
ELBERTON GA



STD5M029.CMP

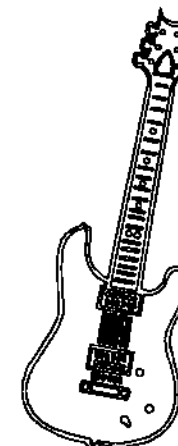

STANDARD GRANITE
ELBERTON GA

STD5M030.CMP

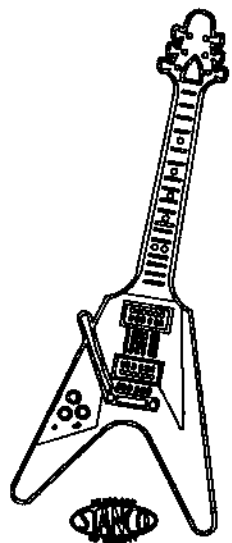

STANDARD GRANITE
ELBERTON GA
STD5M031 .CMP

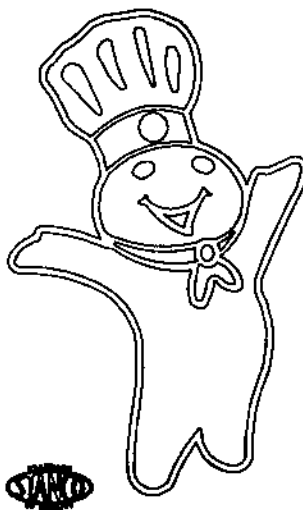

STANDARD GRANITE
ELBERTON GA
STD5M032 .CMP

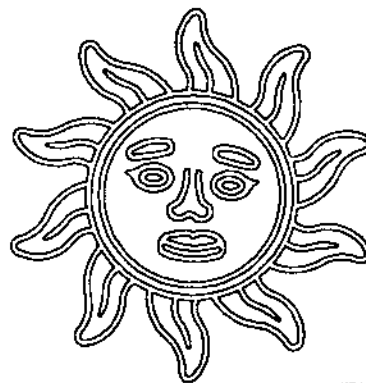

STANDARD GRANITE
ELBERTON GA

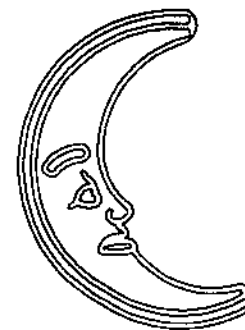

STD5M033 .CMP

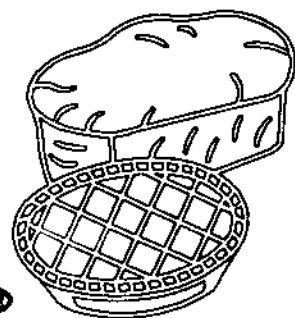

STANDARD GRANITE
ELBERTON GA
STD5M034 .CMP

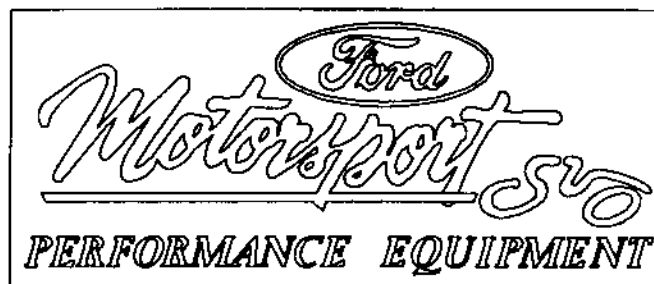

STANDARD GRANITE
ELBERTON GA

STD5M035 .CMP

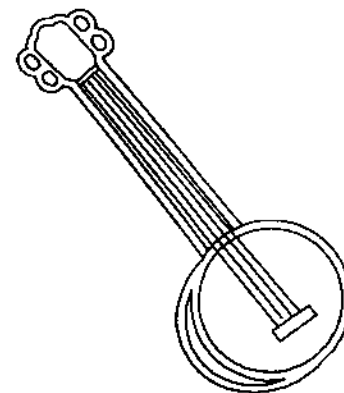

CENTRAL GRANITE CO.
ELBERTON GA
STD5M036 .CMP



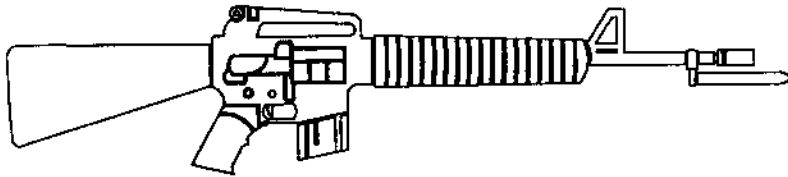

CENTRAL GRANITE CO.
ELBERTON GA STD5M037.CMP

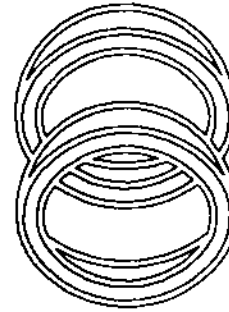

CENTRAL GRANITE CO.
ELBERTON GA STD5M038.CMP

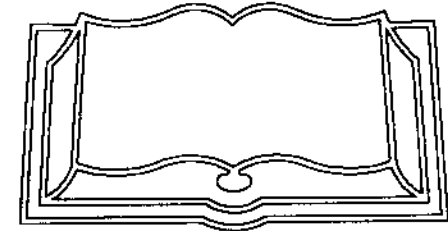

CENTRAL GRANITE CO.
ELBERTON GA STD5M039.CMP

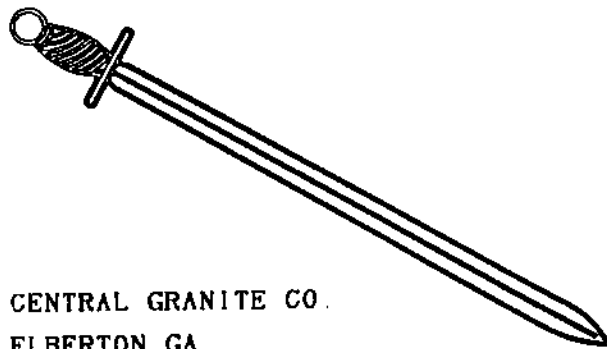

CENTRAL GRANITE CO.
ELBERTON GA STD5M040.CMP

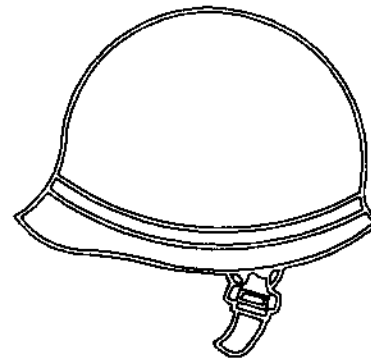

CENTRAL GRANITE CO.
ELBERTON GA STD5M041.CMP

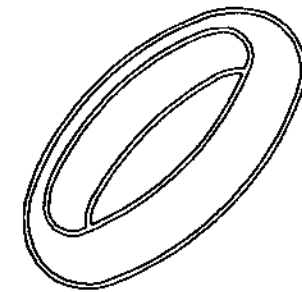

CENTRAL GRANITE CO.
ELBERTON GA STD5M042.CMP



N.C. MARBLE & GRANITE
CLINTON NC

STD5M043.CMP



4.125 x 17.375
ARCHIE MON. & STONE
WATERTOWN WI
STD5M044.CMP

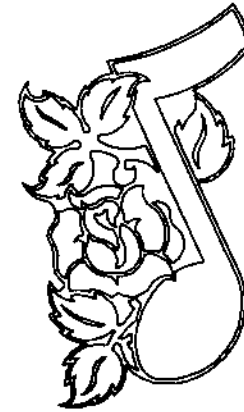

4.5 x 7.75
ARCHIE MON. & STONE
WATERTOWN WI
STD5M045.CMP

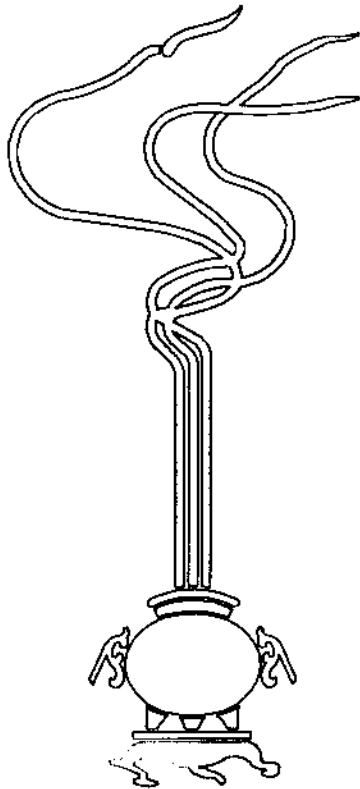

GRANITE LACROIX
VIMONT-LAVAL QUEBEC
STD5M046.CMP

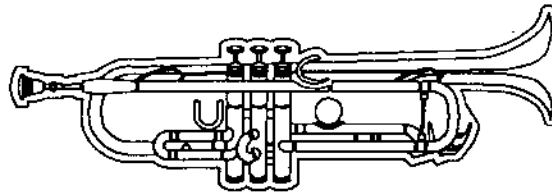

GRANITE LACROIX
VIMONT-LAVAL QUEBEC
STD5M047.CMP



GRANITE LACROIX
VIMONT-LAVAL QUEBEC
STD5M048.CMP



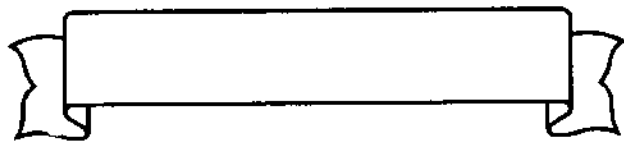

BREWER MONUMENT CO.
PERRYVILLE MO. STD5M049 .CMP



BREWER MONUMENT CO.
PERRYVILLE MO.
STD5M050 .CMP

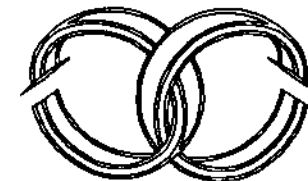

BREWER MONUMENT CO.
PERRYVILLE MO.
STD5M051 .CMP

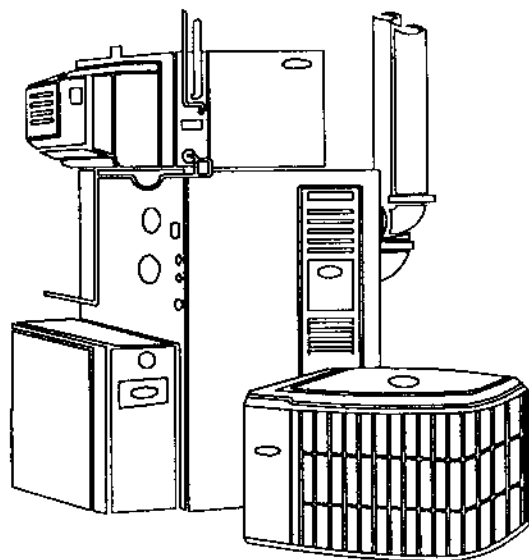

BREWER MONUMENT CO.
PERRYVILLE MO.
STD5M052 .CMP



BREWER MONUMENT CO.
PERRYVILLE MO.
STD5M053 .CMP



BREWER MONUMENT CO.
PERRYVILLE MO.
STD5M054 .CMP

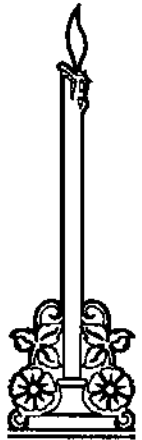

STD5M055 .CMP

AMITE MARBLE & GRANITE
AMITE LA



BEALL

AMITE MARBLE & GRANITE
AMITE LA STD5M059 .CMP

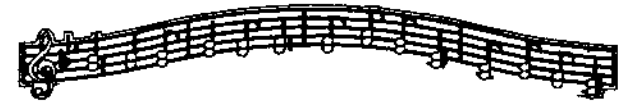

EDWIN F. NICKOL
VERSAILLES OH STD5M060 .CMP

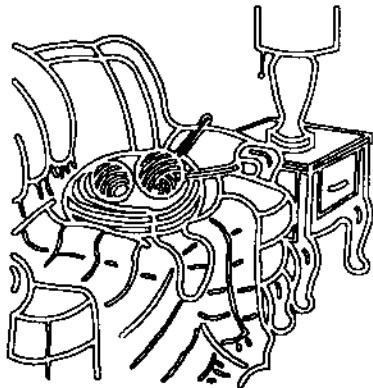

AMITE MARBLE & GRANITE
AMITE LA
 STD5M056 .CMP

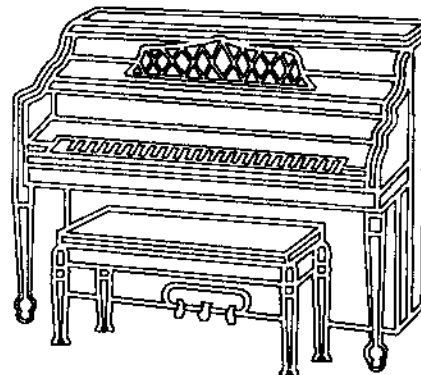

AMITE MARBLE & GRANITE
AMITE LA
 STD5M057 .CMP



AMITE MARBLE & GRANITE
AMITE LA STD5M058 .CMP

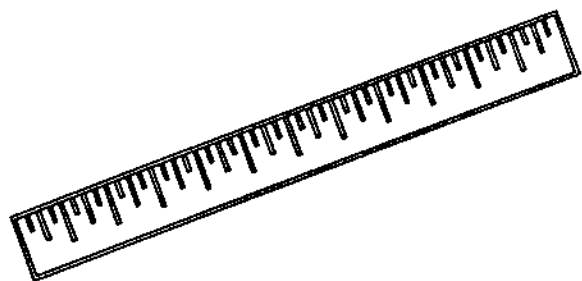

EDWIN F. NICKOL
VERSAILLES OH
STD5M061.CMP

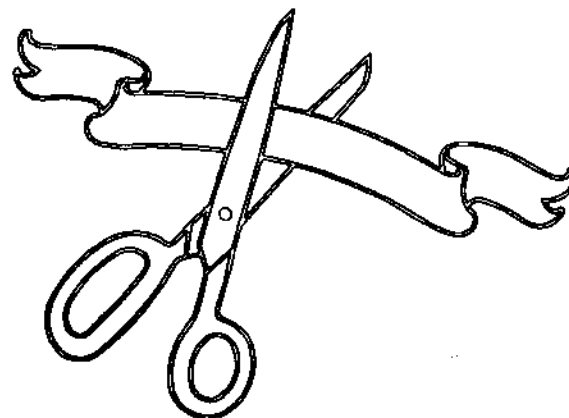

EDWIN F. NICKOL
VERSAILLES OH STD5M062.CMP

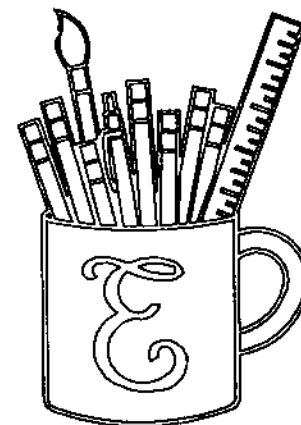

EDWIN F. NICKOL
VERSAILLES OH
STD5M063.CMP



EDWIN F. NICKOL
VERSAILLES OH STD5M064.CMP



GALLAGHER MONUMENTS
MALAGA OH STD5M065.CMP

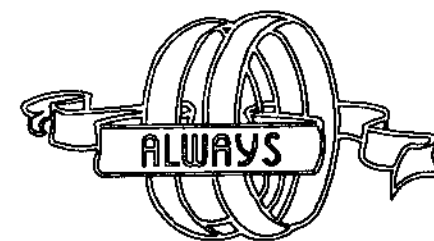

GALLAGHER MONUMENTS
MALAGA OH STD5M066.CMP

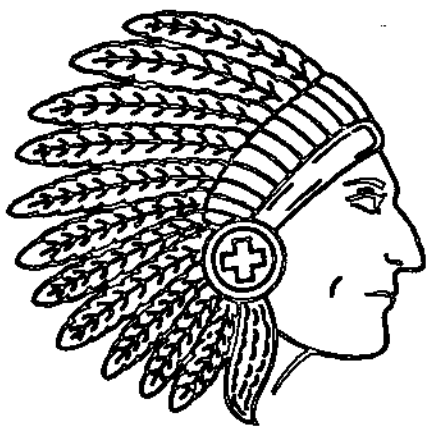

GALLAGHER MONUMENTS
MALAGA OH

STD5M067.CMP

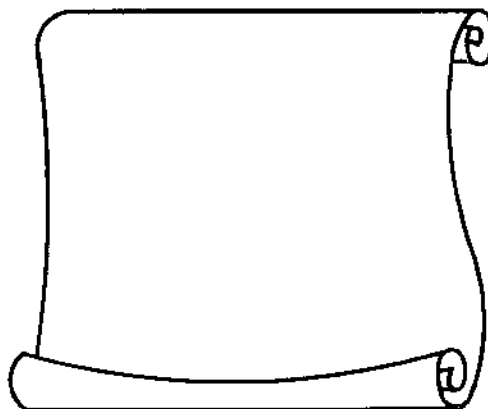

GALLAGHER MONUMENTS
MALAGA OH

STD5M068.CMP

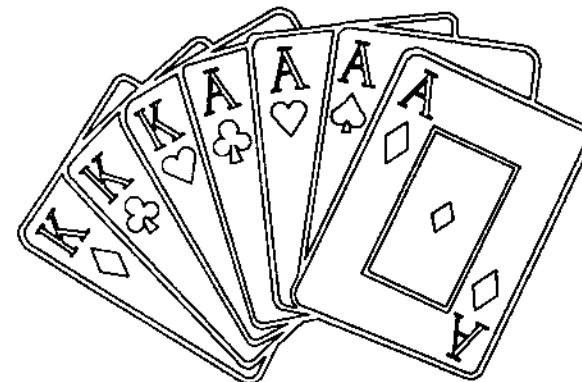

ERIE CITY MEMORIALS

ERIE PA STD5M069.CMP



ERIE CITY MEMORIALS

ERIE PA STD5M070.CMP



MASTERCARVED MEMORIALS

CLAY CENTER KS

STD5M071.CMP

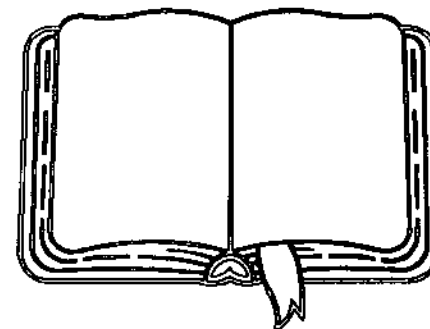

MASTERCARVED MEMORIALS

CLAY CENTER KS

STD5M072.CMP

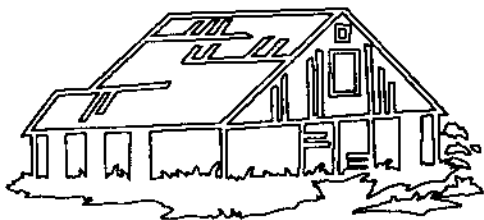

WOODWARD MONUMENT
VICI OK STD5M073.CMP

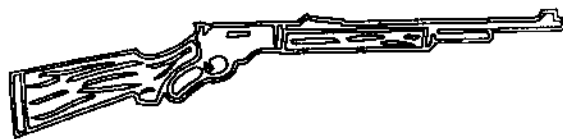

WOODWARD MONUMENT
VICI OK STD5M074.CMP

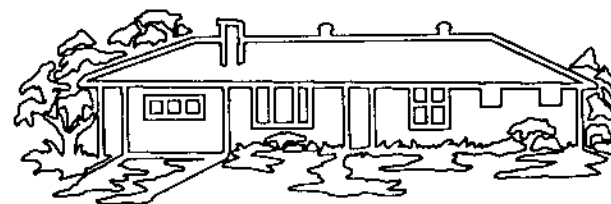

WOODWARD MONUMENT
VICI OK STD5M075.CMP

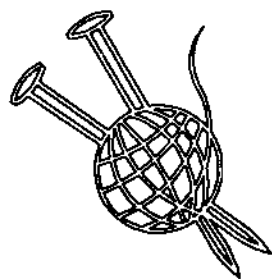

WOODWARD MONUMENT
VICI OK STD5M076.CMP



RUST-UNGER MONUMENTS
COLUMBUS IN STD5M077.CMP



RUST-UNGER MONUMENTS
COLUMBUS IN STD5M078.CMP

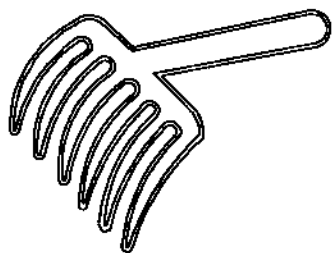

STATEWIDE MEMORIALS
BRUNSWICK ME
STD5M079.CMP



STATEWIDE MEMORIALS
BRUNSWICK ME
STD5M080.CMP



STATEWIDE MEMORIALS
BRUNSWICK ME
STD5M081.CMP

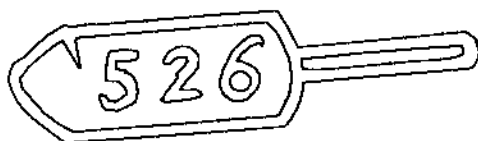

STATEWIDE MEMORIALS
BRUNSWICK ME
STD5M082.CMP



SEAMON-POE MONUMENT CO.
SAN DIEGO CA
STD5M083.CMP

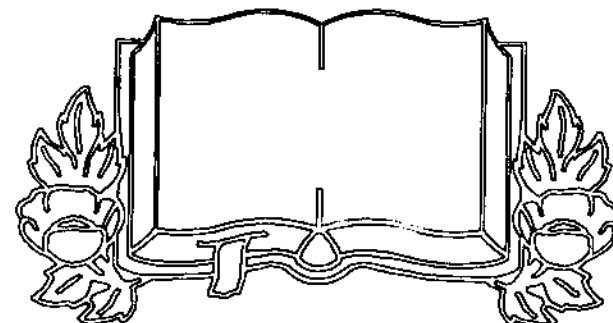

SEAMON-POE MONUMENT CO.
SAN DIEGO CA
STD5M084.CMP



SEAMON-POE MONUMENT CO.
SAN DIEGO CA

STD5M085.CMP

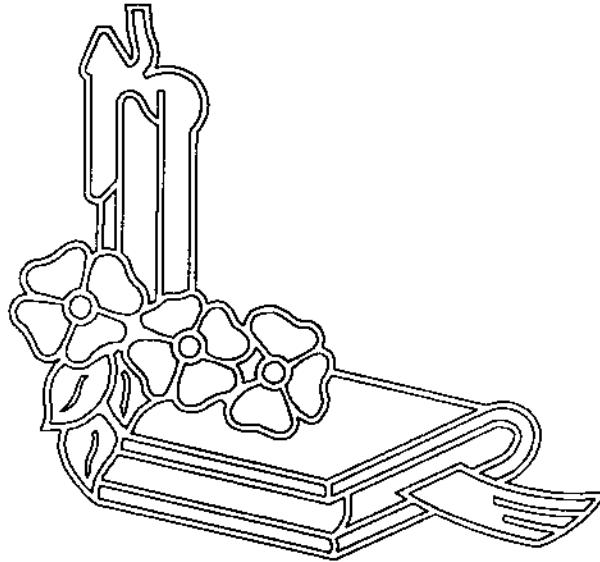

SEAMON-POE MONUMENT CO.
SAN DIEGO CA

STD5M086.CMP

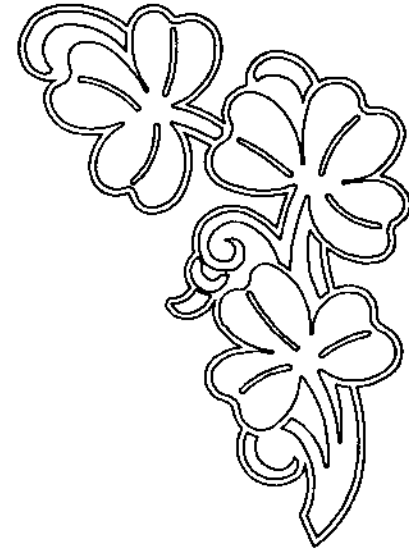

PLETZER MON. DESIGN
BARRE VT

STD5M087.CMP

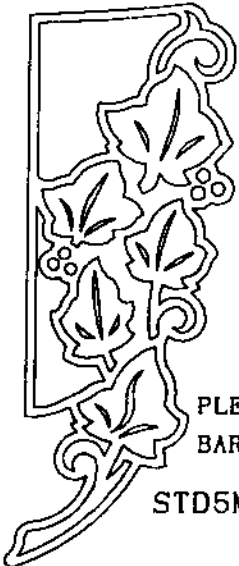

PLETZER MON. DESIGN
BARRE VT

STD5M088.CMP

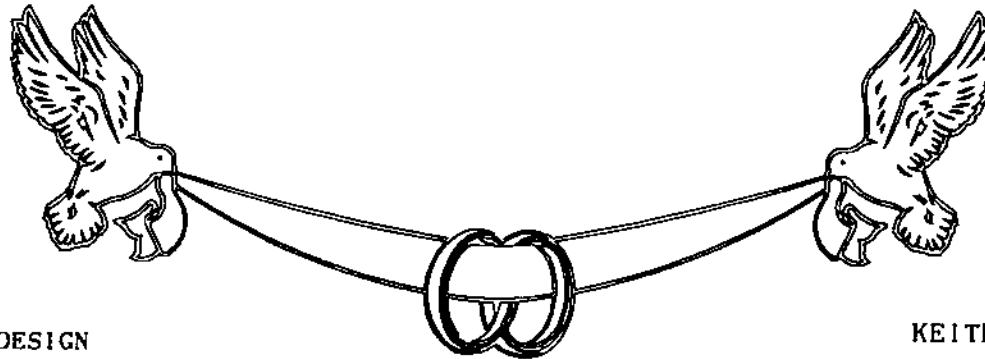

KEITH MONUMENT CO.
ELIZABETHTOWN KY

STD5M089.CMP



KEITH MONUMENT CO.
ELIZABETHTOWN KY

STD5M090.CMP



KEITH MONUMENT CO.
ELIZABETHTOWN KY
STD5M091 .CMP

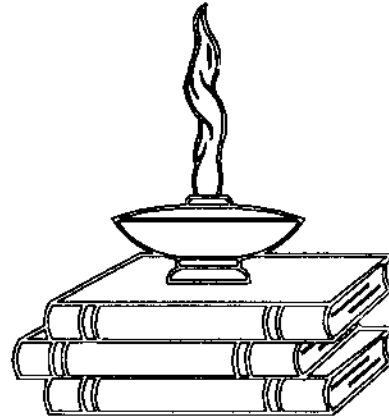

KEITH MONUMENT CO.
ELIZABETHTOWN KY
STD5M092 .CMP



PALMER MONUMENT CO.
BROKEN BOW NE
STD5M093 .CMP



ELBERTON OFFICE SUPPLY
ELBERTON GA
STD5M094 .CMP

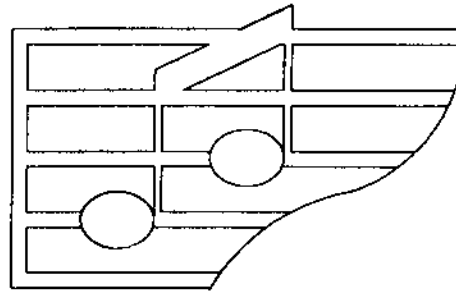

MILLER BROS. MONUMENT
IOWA CITY IA
STD5M095 .CMP



MILLER BROS. MONUMENT
IOWA CITY IA
STD5M096 .CMP



MILLER BROS. MONUMENT
IOWA CITY IA
STD5M097.CMP

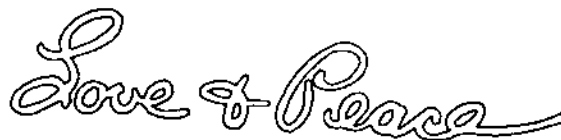

MILLER BROS. MONUMENT
IOWA CITY IA
STD5M098.CMP

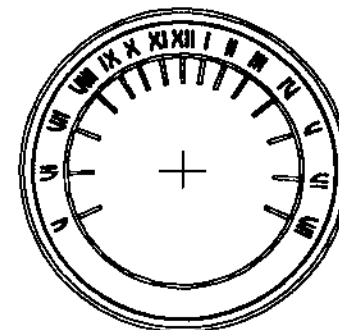

MILLER BROS. MONUMENT
IOWA CITY IA
STD5M099.CMP

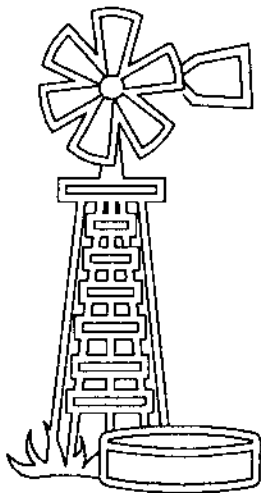

MILLER BROS. MONUMENT
IOWA CITY IA
STD5M100.CMP

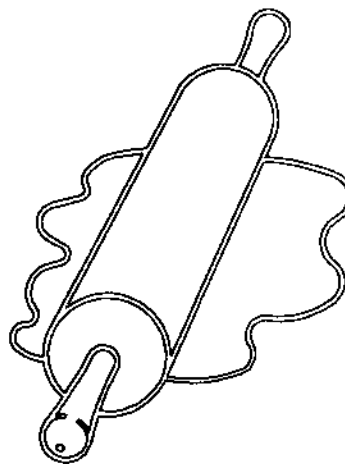

ST. CHARLES MEMORIAL WORKS
ST. CHARLES IL
STD5M101.CMP



ST. CHARLES MEMORIAL WORKS
ST. CHARLES IL
STD5M102.CMP

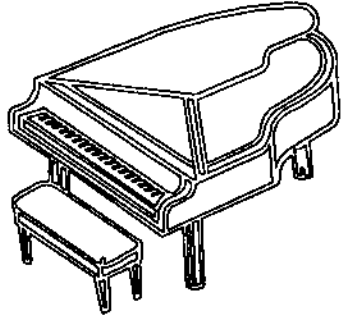

ST. CHARLES MEMORIAL WORKS
ST. CHARLES IL

STD5M103.CMP



ST. CHARLES MEMORIAL WORKS
ST. CHARLES IL

STD5M104.CMP

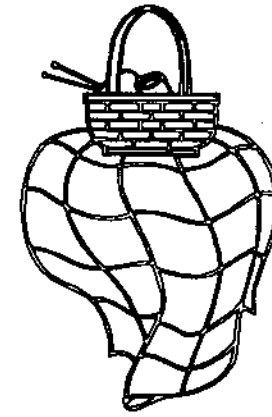

ROLLA MONUMENT CO.
ROLLA MO

STD5M105.CMP



ROLLA MONUMENT CO.
ROLLA MO

STD5M106.CMP



ROLLA MONUMENT CO.
ROLLA MO

STD5M107.CMP



ROLLA MONUMENT CO.
ROLLA MO

STD5M108.CMP

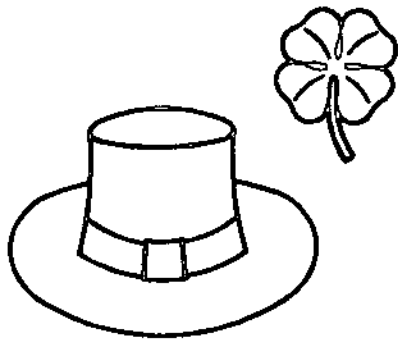

ADVANCED MEMORIAL DESIGN
MORRISTOWN TN

STD5M109.CMP

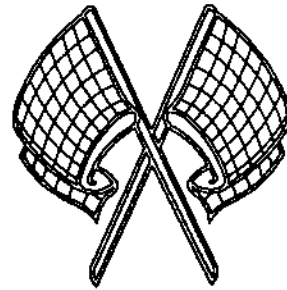

ADVANCED MEMORIAL DESIGN
MORRISTOWN TN

STD5M110.CMP

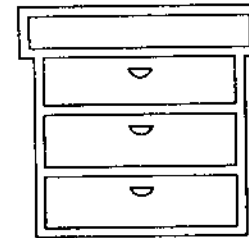

ADVANCED MEMORIAL DESIGN
MORRISTOWN TN

STD5M111.CMP

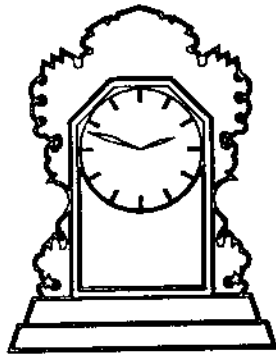

ADVANCED MEMORIAL DESIGN
MORRISTOWN TN

STD5M112.CMP

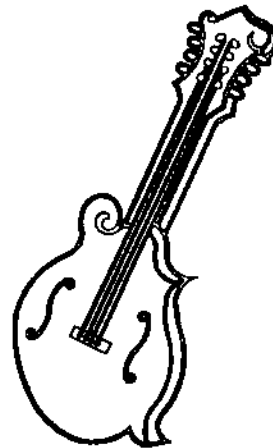

ADVANCED MEMORIAL DESIGN
MORRISTOWN TN

STD5M113.CMP

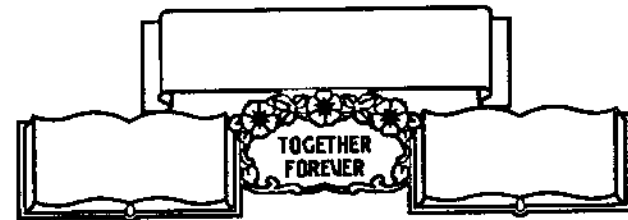

MILACEK MONUMENT CO.
OMAHA NE

STD5M114.CMP

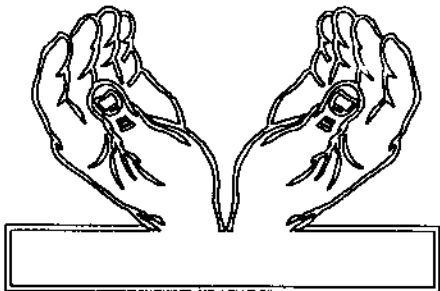

MILACEK MONUMENT CO.
OMAHA NE

STD5M115.CMP

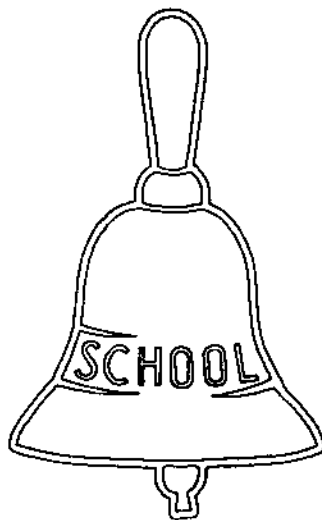

MILACEK MONUMENT CO.
OMAHA NE

STD5M116.CMP

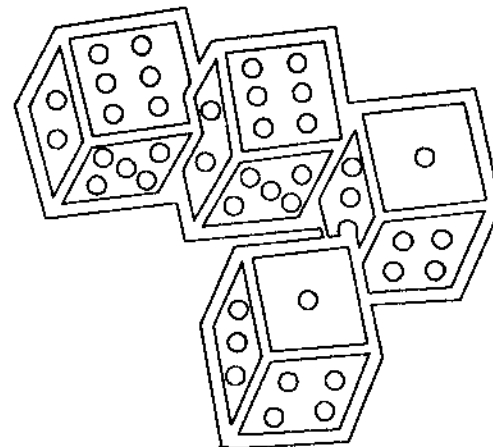

MILACEK MONUMENT CO.
OMAHA NE

STD5M117.CMP

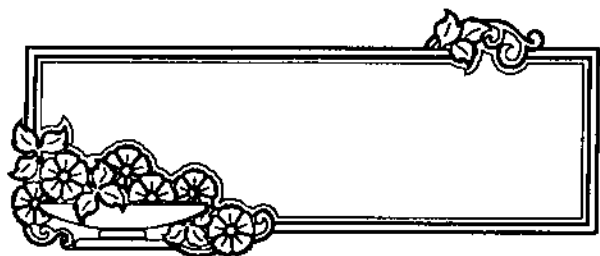

MILLIGAN MEMORIALS
COSHOCOTON OH

STD5M118.CMP

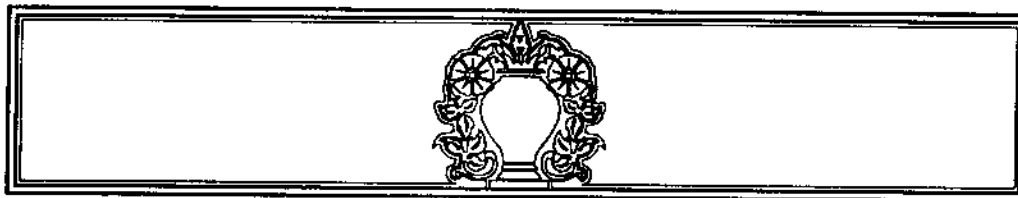

MILLIGAN MEMORIALS
COSHOCOTON OH

STD5M119.CMP

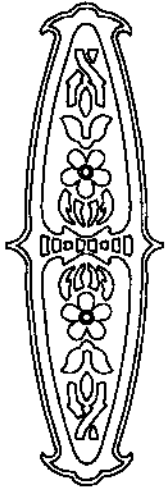

MILLIGAN MEMORIALS
COSHOCKTON OH

STD5M120.CMP



MILLIGAN MEMORIALS
COSHOCKTON OH

STD5M121.CMP

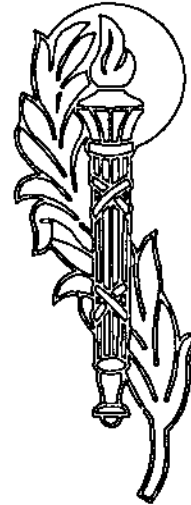

MILLIGAN MEMORIALS
COSHOCKTON OH

STD5M122.CMP

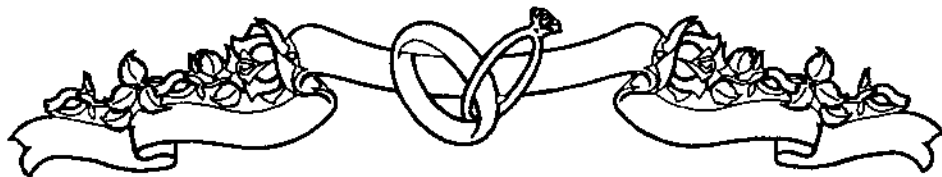

MILLIGAN MEMORIALS
COSHOCKTON OH

STD5M123.CMP



SHEVCHENKO MONUMENTAL WORKS
PERTH AMBOY NJ

STD5M124.CMP

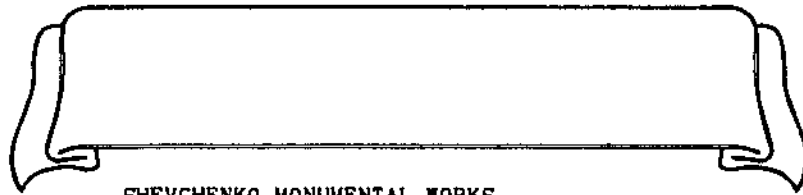

SHEVCHENKO MONUMENTAL WORKS
PERTH AMBOY NJ

STD5M125.CMP



SHEVCHENKO MONUMENTAL WORKS
PERTH AMBOY NJ

STD5M126.CMP

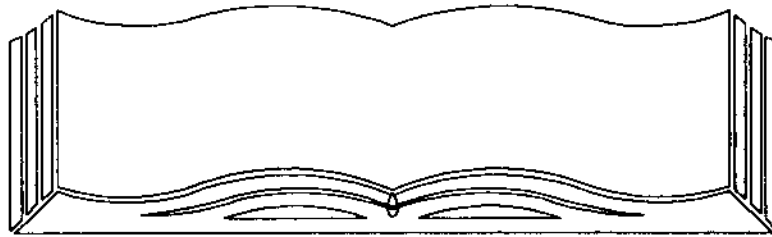

SHEVCHENKO MONUMENTAL WORKS
PERTH AMBOY NJ

STD5M127.CMP

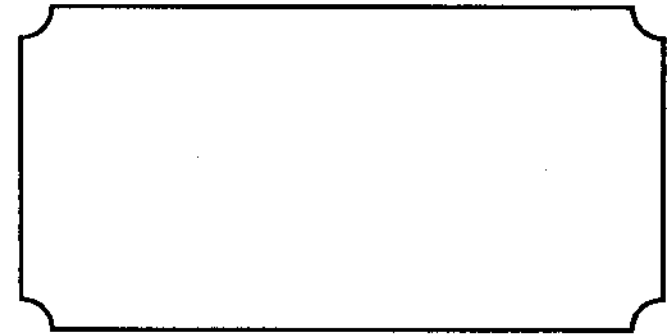

SHEVCHENKO MONUMENTAL WORKS
PERTH AMBOY NJ

STD5M128.CMP

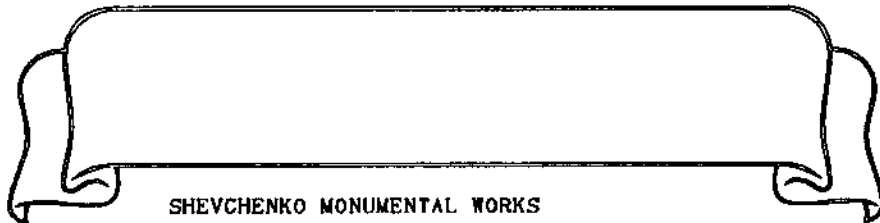

SHEVCHENKO MONUMENTAL WORKS
PERTH AMBOY NJ

STD5M129.CMP



SHEVCHENKO MONUMENTAL WORKS
PERTH AMBOY NJ

STD5M130.CMP



FOREVER IN OUR HEARTS

SHEVCHENKO MONUMENTAL WORKS
PERTH AMBOY NJ

STD5M131.CMP



SHEVCHENKO MONUMENTAL WORKS
PERTH AMBOY NJ

STD5M132.CMP

FOREVER IN OUR HEARTS

SHEVCHENKO MONUMENTAL WORKS
PERTH AMBOY NJ

STD5M133.CMP



SHEVCHENKO MONUMENTAL WORKS
PERTH AMBOY NJ

STD5M134.CMP

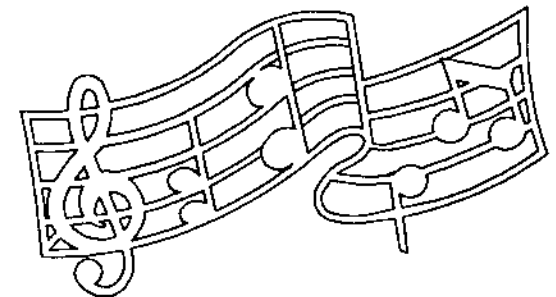

QUALITY-CUT MONUMENTAL DESIGNS
ELBERTON GA

STD5M135.CMP

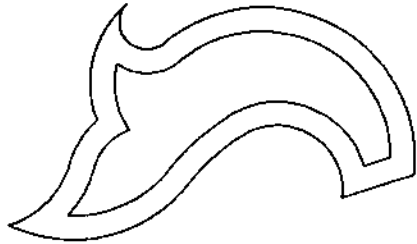

SEBASTIANO AIELLO MONUMENTS INC
MONTREAL QUEBEC CANADA

STD5M136.CMP

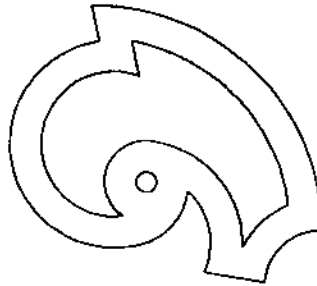

SEBASTIANO AIELLO MONUMENTS INC
MONTREAL QUEBEC CANADA

STD5M137.CMP

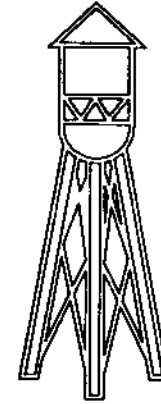

BOYCE MONUMENTAL SALES LTD
CARROLL IA

STD5M138.CMP

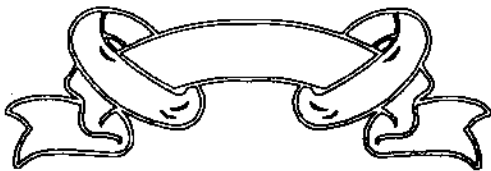

BOYCE MONUMENTAL SALES LTD
CARROLL IA

STD5M139.CMP

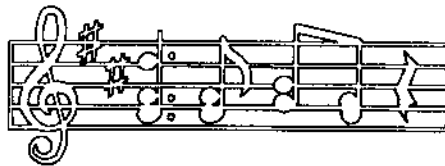

BAY MONUMENT CO
BAY CITY MI

STD5M140.CMP

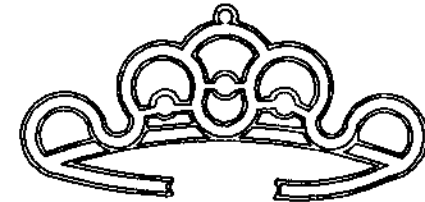

BAY MONUMENT CO
BAY CITY MI

STD5M141.CMP



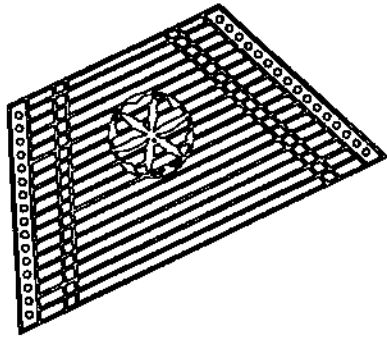

BAY MONUMENT CO
BAY CITY MI

STD5M142.CMP

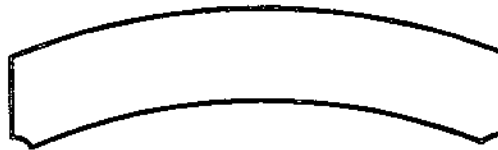

RMG STONE PRODUCTS
CASTLETON VT

STD5M143.CMP

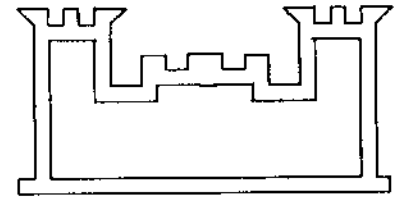

RMG STONE PRODUCTS
CASTLETON VT

STD5M144.CMP

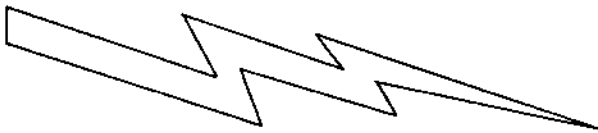

RMG STONE PRODUCTS
CASTLETON VT

STD5M145.CMP

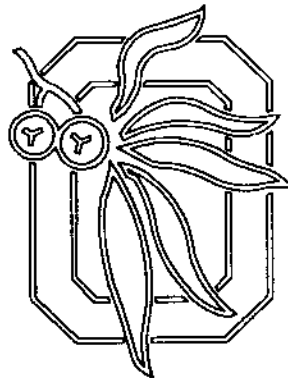

LONGSTRETH MEMORIALS
GALION OH

STD5M146.CMP

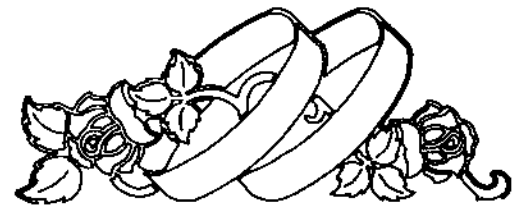

LONGSTRETH MEMORIALS
GALION OH

STD5M147.CMP

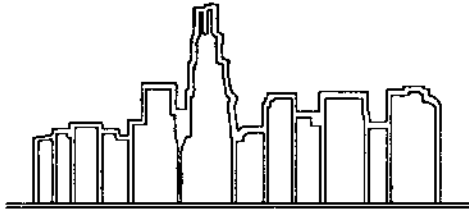

J.W. REYNOLDS MONUMENTS
VIENNA IL

STD5M148.CMP

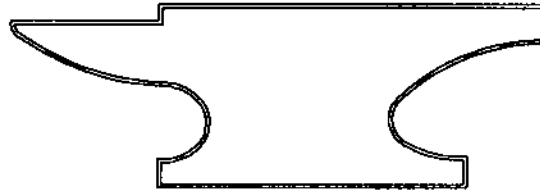

J.W. REYNOLDS MONUMENTS
VIENNA IL

STD5M149.CMP



J.W. REYNOLDS MONUMENTS
VIENNA IL

STD5M150.CMP

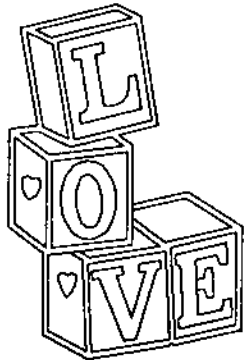

J.W. REYNOLDS MONUMENTS
VIENNA IL

STD5M151.CMP

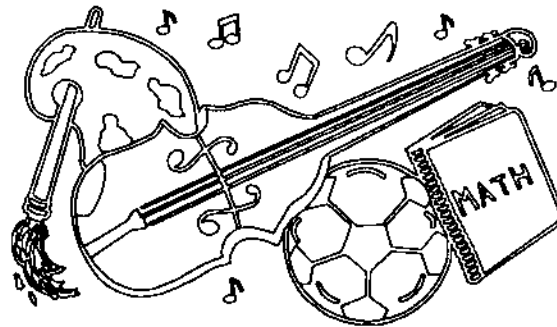

J.W. REYNOLDS MONUMENTS
VIENNA IL

STD5M152.CMP

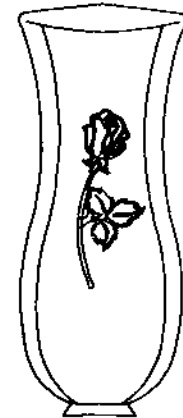

CROWN MONUMENT
WARREN OH

STD5M153.CMP



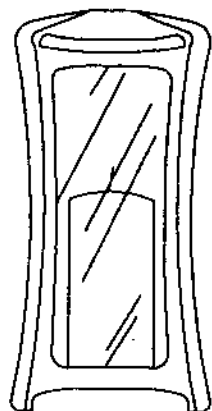

CROWN MONUMENT
WARREN OH

STD5M154.CMP

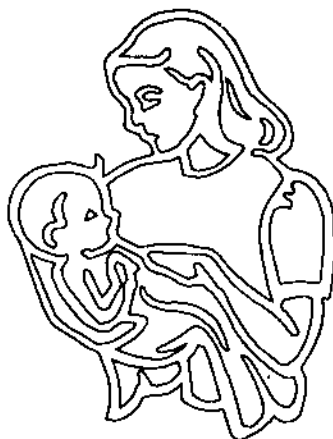

CROWN MONUMENT
WARREN OH

STD5M155.CMP

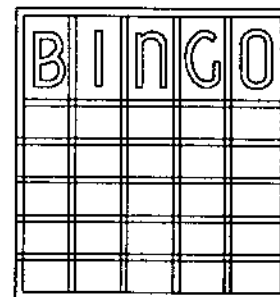

CROWN MONUMENT
WARREN OH

STD5M158.CMP

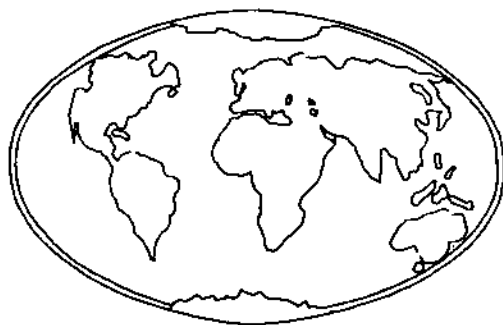

CROWN MONUMENT
WARREN OH

STD5M157.CMP



CROWN MONUMENT
WARREN OH

STD5M158.CMP

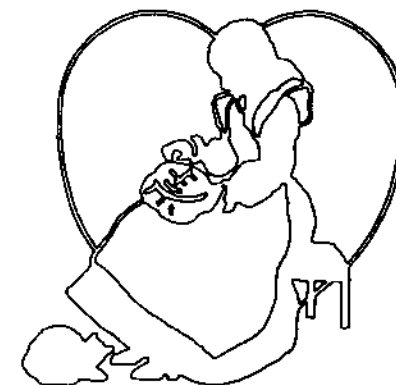

W.P. SIMMONS, INC.
MT. AIRY NC

STD5M159.CMP

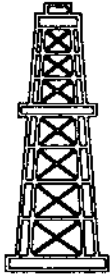

CAPITOL HILL MONUMENT
OKLAHOMA CITY OK

STD5M160.CMP

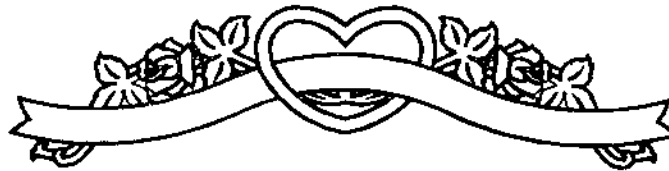

CAPITOL HILL MONUMENT
OKLAHOMA CITY OK

STD5M161.CMP

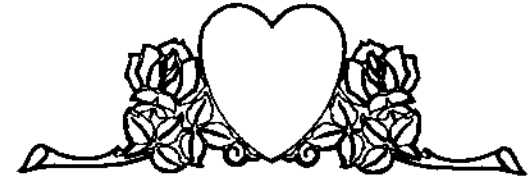

CAPITOL HILL MONUMENT
OKLAHOMA CITY OK

STD5M162.CMP

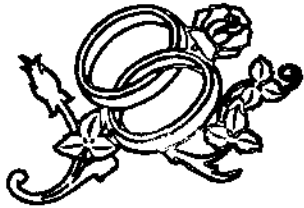

CAPITOL HILL MONUMENT
OKLAHOMA CITY OK

STD5M163.CMP

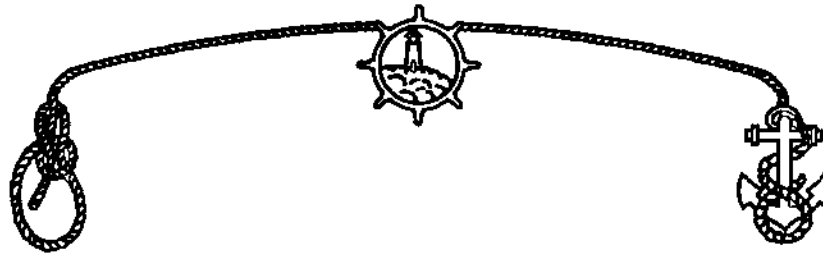

SMYTH MEMORIAL CO
CHATHAM ONTARIO CANADA

STD5M164.CMP

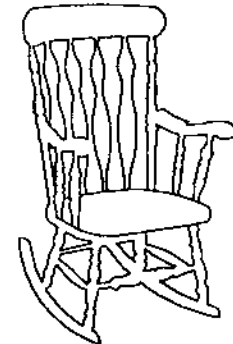

SMYTH MEMORIAL CO
CHATHAM ONTARIO CANADA

STD5M165.CMP



SMYTH MEMORIAL CO
CHATHAM ONTARIO CANADA

STD5M166.CMP



MILANO MONUMENTS
CLEVELAND OH

STD5M167.CMP

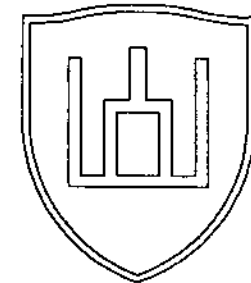

MILANO MONUMENTS
CLEVELAND OH

STD5M168.CMP

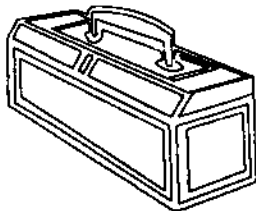

MOORE MONUMENT CO
CHILLICOTHE MO

STD5M169.CMP



MOORE MONUMENT CO
CHILLICOTHE MO

STD5M170.CMP

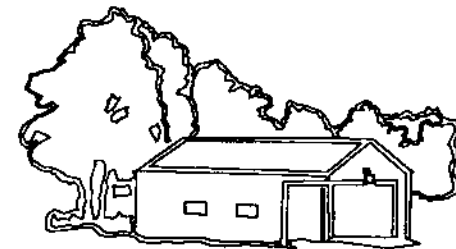

MOORE MONUMENT CO
CHILLICOTHE MO

STD5M171.CMP

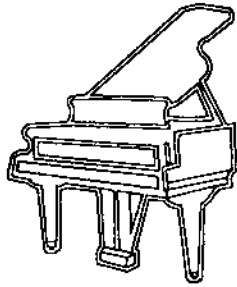

MOORE MONUMENT CO
CHILLICOTHE MO

STD5M172 .CMP



PEORIA MONUMENT CO
PEORIA IL

STD5M173 .CMMP

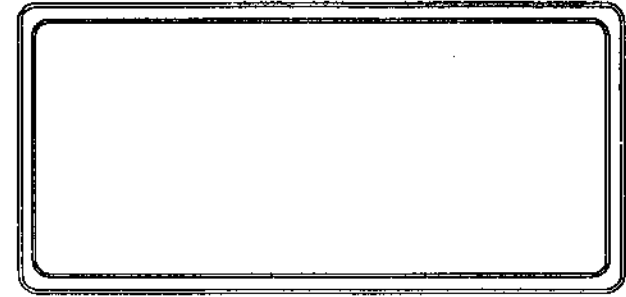

PEORIA MONUMENT CO
PEORIA IL

STD5M174 .CMP

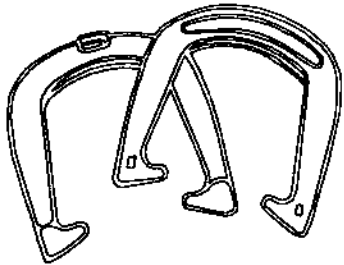

JAMESTOWN MONUMENT
JAMESTOWN ND

STD5M175 .CMP

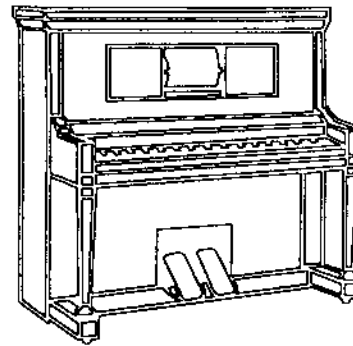

JAMESTOWN MONUMENT
JAMESTOWN ND

STD5M176 .CMP



HAMILTON MEMORIALS
HAMILTON ONTARIO CANADA

STD5M177 .CMP

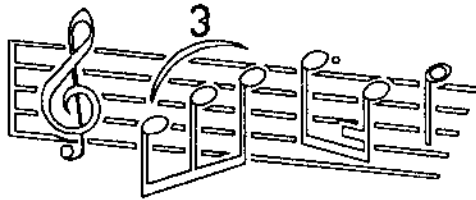

HAMILTON MEMORIALS
HAMILTON ONTARIO CANADA

STD5M178.CMP

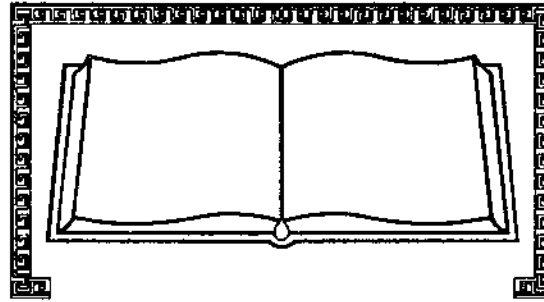

HAMILTON MEMORIALS
HAMILTON ONTARIO CANADA

STD5M179.CMP

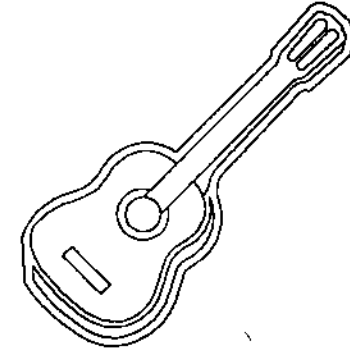

HAMILTON MEMORIALS
HAMILTON ONTARIO CANADA

STD5M180.CMP



McGARRY MEMORIALS
CHORLTON MANCHESTER UK

STD5M181.CMP

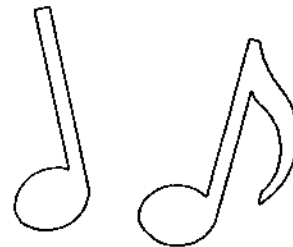

SOUTH BEND MONUMENT WORKS
SOUTH BEND IN

STD5M182.CMP



SOUTH BEND MONUMENT WORKS
SOUTH BEND IN

STD5M183.CMP

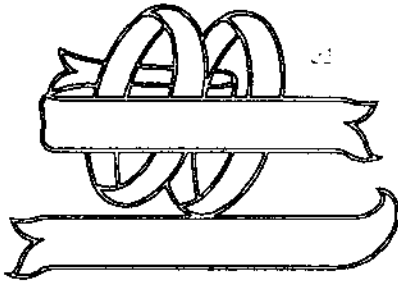

SOUTH BEND MONUMENT WORKS
SOUTH BEND IN

STD5M184.CMP

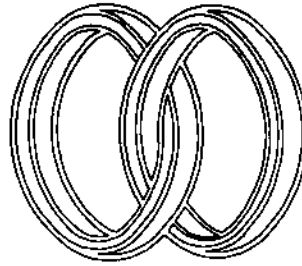

SOUTH BEND MONUMENT WORKS
SOUTH BEND IN

STD5M185.CMP

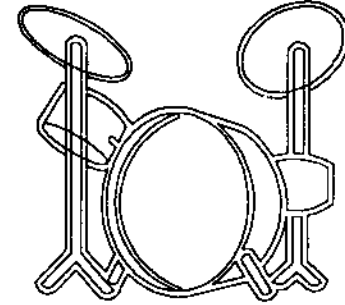

SOUTH BEND MONUMENT WORKS
SOUTH BEND IN

STD5M186.CMP



SOUTH BEND MONUMENT WORKS
SOUTH BEND IN

STD5M187.CMP

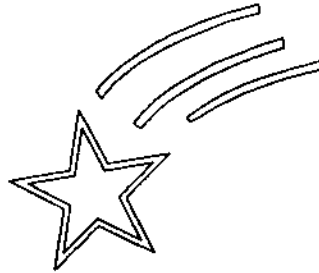

BARRE MEMORIALS
HYDE PARK NY

STD5M188.CMP



BARRE MEMORIALS
HYDE PARK NY

STD5M189.CMP

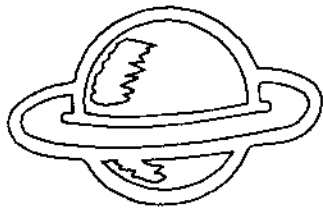

BARRE MEMORIALS
HYDE PARK NY

STD5M190.CMP

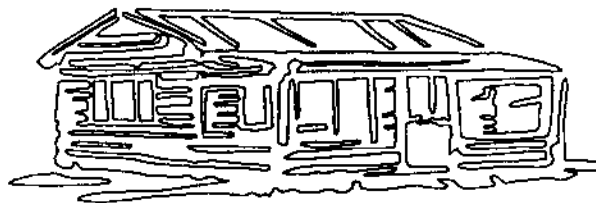

BEESEY MONUMENT CO
PROVO UT

STD5M191.CMP



BEESEY MONUMENT CO
PROVO UT

STD5M192.CMP

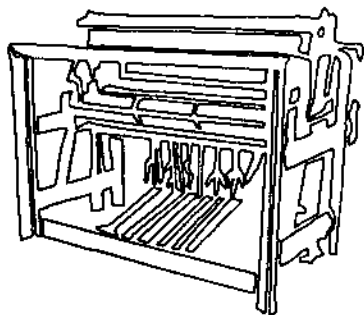

BEESEY MONUMENT CO
PROVO UT

STD5M193.CMP

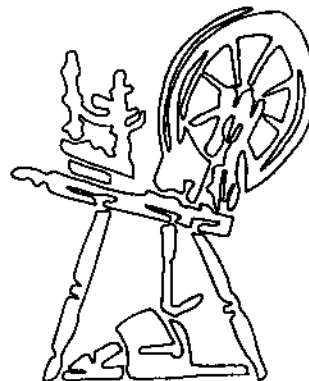

BEESEY MONUMENT CO
PROVO UT

STD5M194.CMP

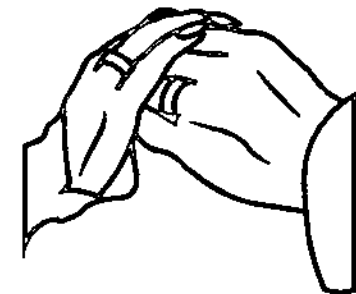

KIRKPATRICK & O'BRINE LTD
FONTHILL ONTARIO CANADA

STD5M195.CMP



KIRKPATRICK & O'BRINE LTD
FONTHILL ONTARIO CANADA

STD5M196 .CMP



KIRKPATRICK & O'BRINE LTD
FONTHILL ONTARIO CANADA

STD5M197 .CMP

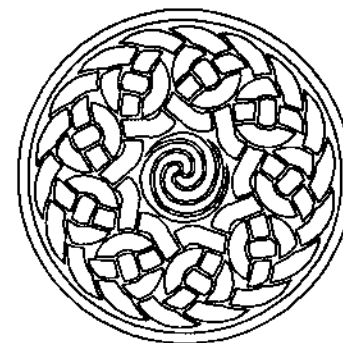

MASTERCRAFT MEMORIALS
RICHMOND IN

STD5M198 .CMP



MASTERCRAFT MEMORIALS
RICHMOND IN

STD5M199 .CMP



MASTERCRAFT MEMORIALS
RICHMOND IN

STD5M200 .CMP



MASTERCRAFT MEMORIALS
RICHMOND IN

STD5M201.CMP

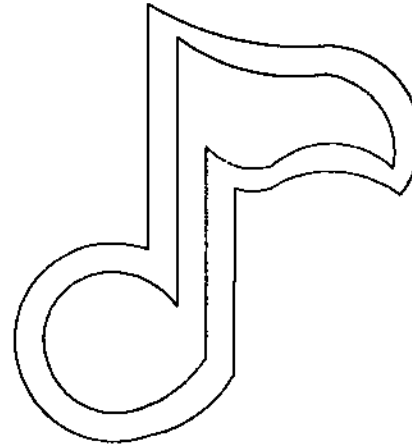

FOREST PARK MEMORIALS
HOUSTON TX

STD5M202.CMP



FOREST PARK MEMORIALS
HOUSTON TX

STD5M203.CMP

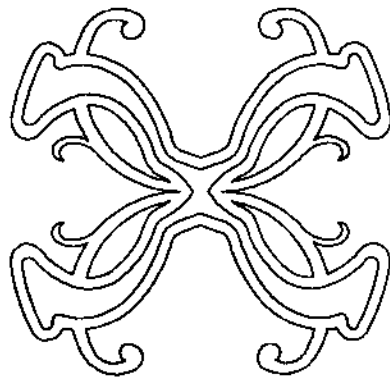

SCHAEFER MONUMENT CO
ST. LOUIS MO

STD5M204.CMP

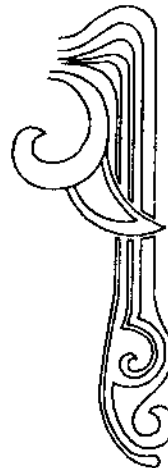

SCHAEFER MONUMENT CO
ST. LOUIS MO

STD5M205.CMP

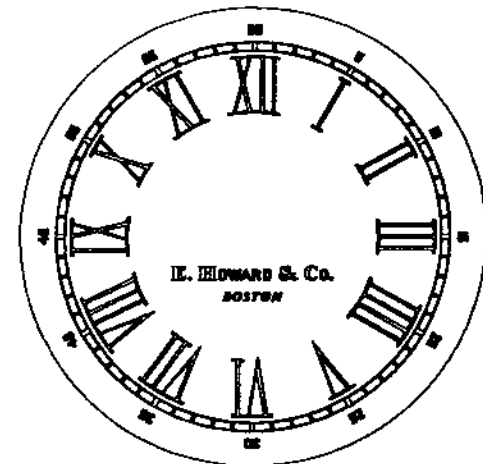

SCHAEFER MONUMENT CO
ST. LOUIS MO

STD5M206.CMP

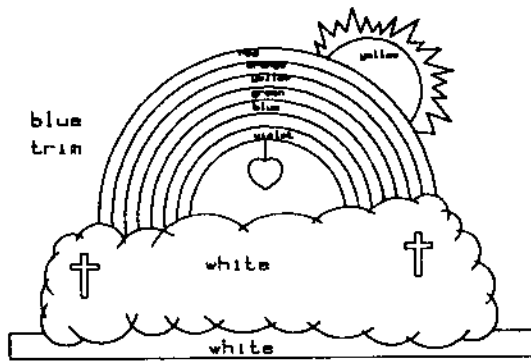

SCHAEFER MONUMENT CO
ST. LOUIS MO

STD5M207.CMP

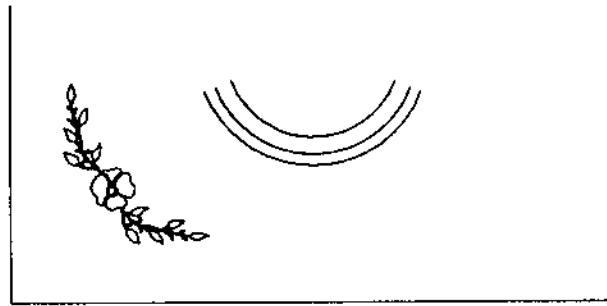

SCHAEFER MONUMENT CO
ST. LOUIS MO

STD5M208.CMP

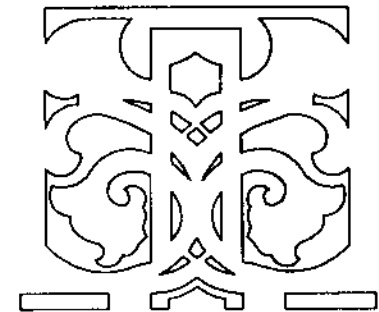

SCHAEFER MONUMENT CO
ST. LOUIS MO

STD5M209.CMP



SCHAEFER MONUMENT CO
ST. LOUIS MO

STD5M210.CMP

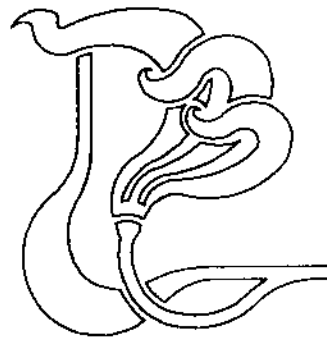

SCHAEFER MONUMENT CO
ST. LOUIS MO

STD5M211.CMP

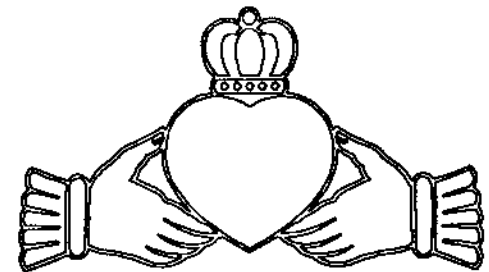

TROY MARBLE & GRANITE WORKS
TROY PA

STD5M212.CMP

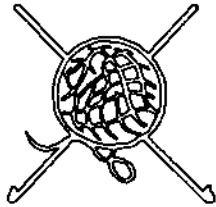

TROY MARBLE & GRANITE WORKS
TROY PA

STD5M213.CMP



TROY MARBLE & GRANITE WORKS
TROY PA

STD5M214.CMP

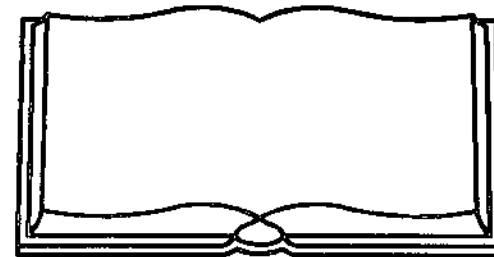

BAILEY MONUMENT CO
WAYCROSS GA

STD5M215.CMP



BAILEY MONUMENT CO
WAYCROSS GA

STD5M216.CMP

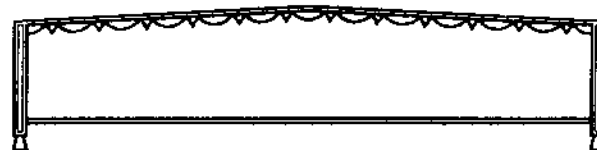

BAILEY MONUMENT CO
WAYCROSS GA

STD5M217.CMP



BAILEY MONUMENT CO
WAYCROSS GA

STD5M218.CMP

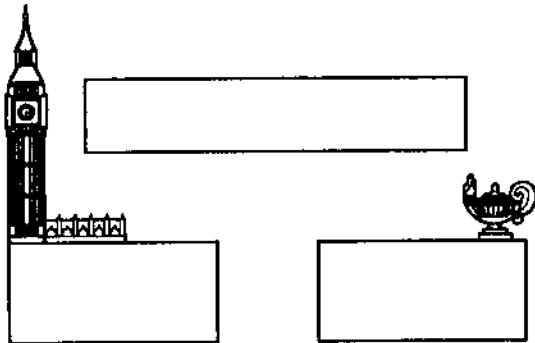

L. J. SERVICES
CHERRY VALLEY NY

STD5M219.CMP

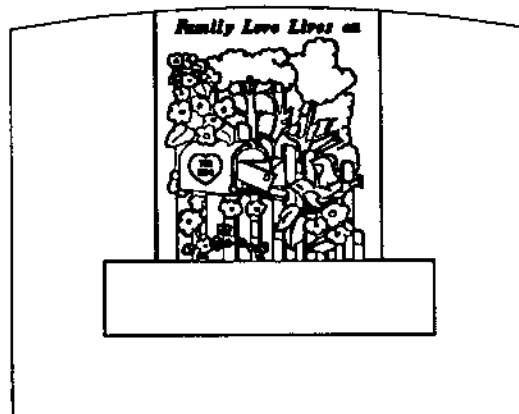

L. J. SERVICES
CHERRY VALLEY NY

STD5M220.CMP



L. J. SERVICES
CHERRY VALLEY NY

STD5M221.CMP



L. J. SERVICES
CHERRY VALLEY NY

STD5M222.CMP

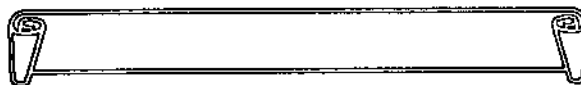

VISALIA GRANITE & MARBLE WORKS
VISALIA CA

STD5M223.CMP



VISALIA GRANITE & MARBLE WORKS
VISALIA CA

STD5M224.CMP

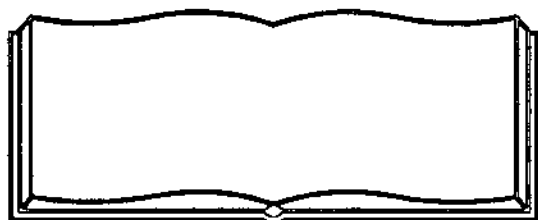

VISALIA GRANITE & MARBLE WORKS
VISALIA CA

STD5M225.CMP

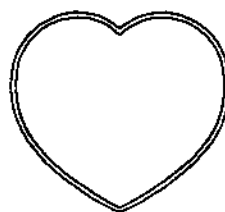

VISALIA GRANITE & MARBLE WORKS
VISALIA CA

STD5M226.CMP

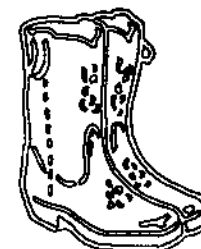

VISALIA GRANITE & MARBLE WORKS
VISALIA CA

STD5M227.CMP

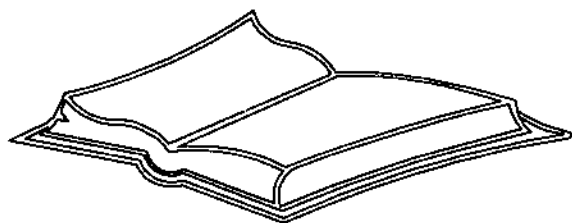

VISALIA GRANITE & MARBLE WORKS
VISALIA CA

STD5M228.CMP



VISALIA GRANITE & MARBLE WORKS
VISALIA CA

STD5M229.CMP



VISALIA GRANITE & MARBLE WORKS
VISALIA CA

STD5M230.CMP



VISALIA GRANITE & MARBLE WORKS
VISALIA CA

STD5M231.CMP

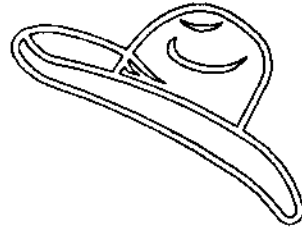

VISALIA GRANITE & MARBLE WORKS
VISALIA CA

STD5M232.CMP

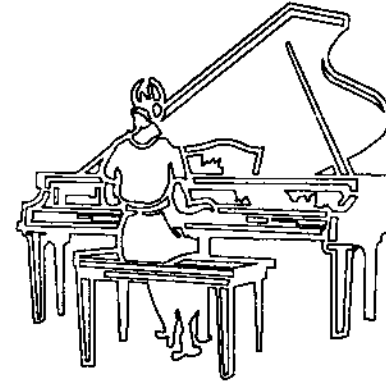

VISALIA GRANITE & MARBLE WORKS
VISALIA CA

STD5M233.CMP

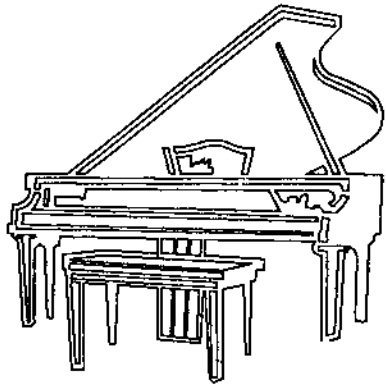

VISALIA GRANITE & MARBLE WORKS
VISALIA CA

STD5M234.CMP

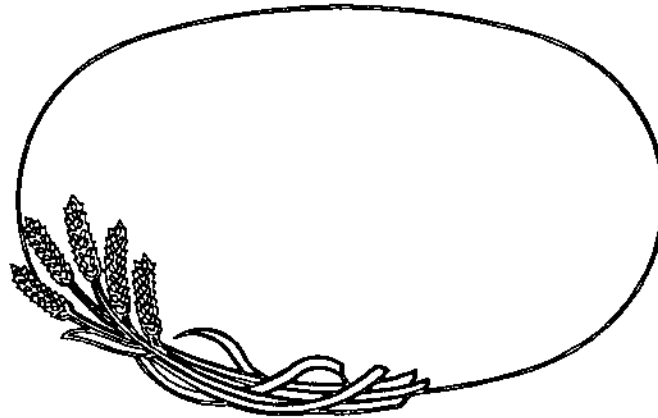

ROCK OF AGES CANADA
BEEBE QUEBEC CANADA

STD5M235.CMP

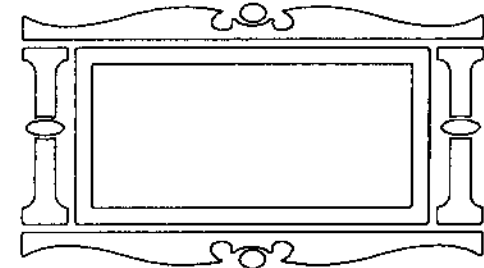

ADAMS MEMORIALS
CHARLESTON IL

STD5M236.CMP



WEARLY MONUMENTS
MUNCIE IN

STD5M237.CMP



WEARLY MONUMENTS
MUNCIE IN

STD5M238.CMP

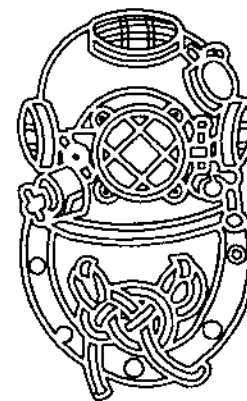

WEARLY MONUMENTS
MUNCIE IN

STD5M239.CMP

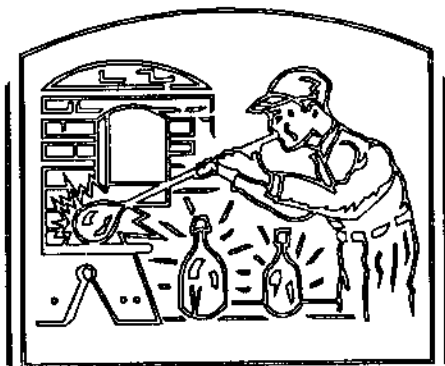

WEARLY MONUMENTS
MUNCIE IN

STD5M240.CMP



WEARLY MONUMENTS
MUNCIE IN

STD5M241.CMP



LANDMARK GRANITE CO
ELBERTON GA

STD5M242 .CMP



RINKER & FRYE MEMORIALS
MT. JACKSON VA

STD5M243 .CMP

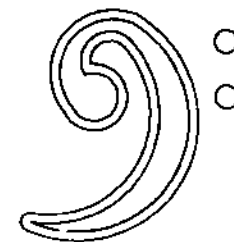

RINKER & FRYE MEMORIALS
MT. JACKSON VA

STD5M244 .CMP

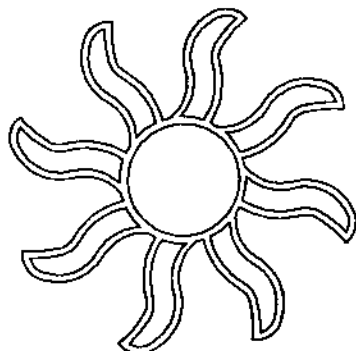

RINKER & FRYE MEMORIALS
MT. JACKSON VA

STD5M245 .CMP

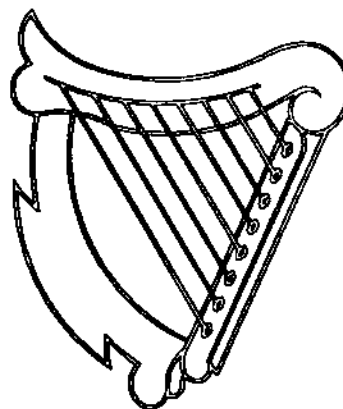

RINKER & FRYE MEMORIALS
MT. JACKSON VA

STD5M246 .CMP

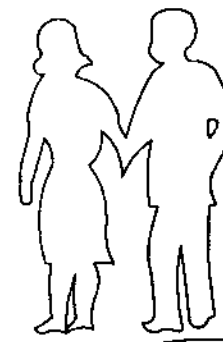

GRIMES BROS. GRANITE CO
ELBERTON GA

STD5M247 .CMP



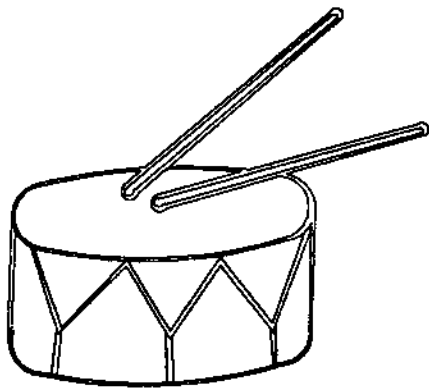

GRIMES BROS. GRANITE CO
ELBERTON GA

STD5M248.CMP

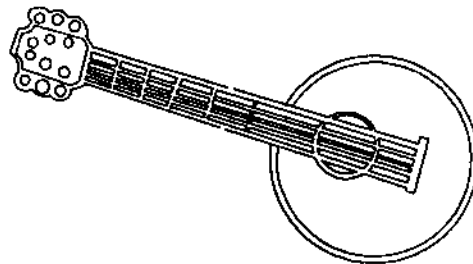

GRIMES BROS. GRANITE CO
ELBERTON GA

STD5M249.CMP

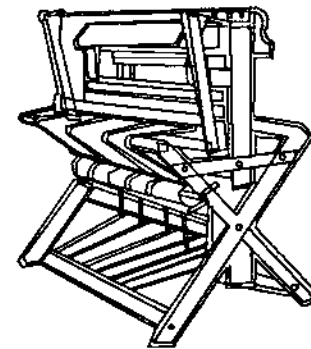

GRIMES BROS. GRANITE CO
ELBERTON GA

STD5M250.CMP



GRIMES BROS. GRANITE CO
ELBERTON GA

STD5M251.CMP

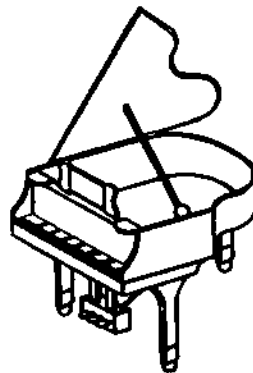

BRACOLONI CUSTOM MEMORIALS
TRENTON NJ

STD5M252.CMP

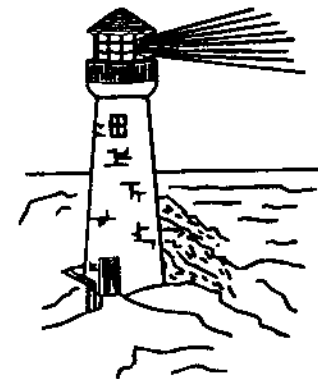

BRACOLONI CUSTOM MEMORIALS
TRENTON NJ

STD5M253.CMP

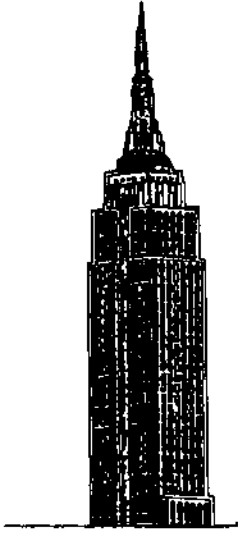

BRACOLONI CUSTOM MEMORIALS
TRENTON NJ

STD5M254.CMP

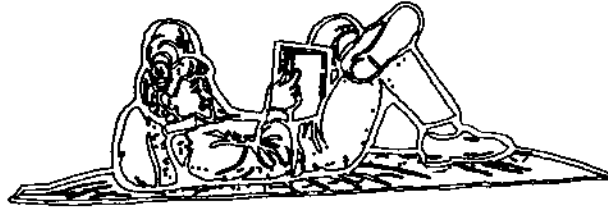

BRACOLONI CUSTOM MEMORIALS
TRENTON NJ

STD5M255.CMP

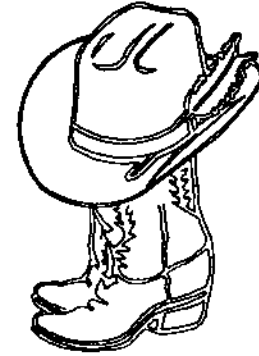

NICHOLSON MONUMENT CO
CLINTON OK

STD5M256.CMP

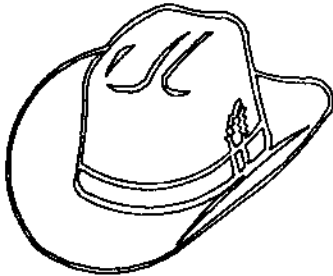

NICHOLSON MONUMENT CO
CLINTON OK

STD5M257.CMP

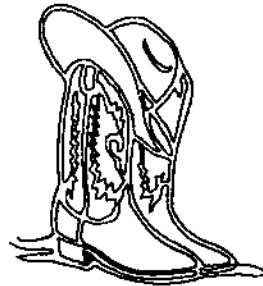

NICHOLSON MONUMENT CO
CLINTON OK

STD5M258.CMP

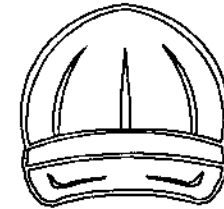

NICHOLSON MONUMENT CO
CLINTON OK

STD5M259.CMP



NICHOLSON MONUMENT CO
CLINTON OK

STD5M260.CMP



NICHOLSON MONUMENT CO
CLINTON OK

STD5M261.CMP



NICHOLSON MONUMENT CO
CLINTON OK

STD5M262.CMP

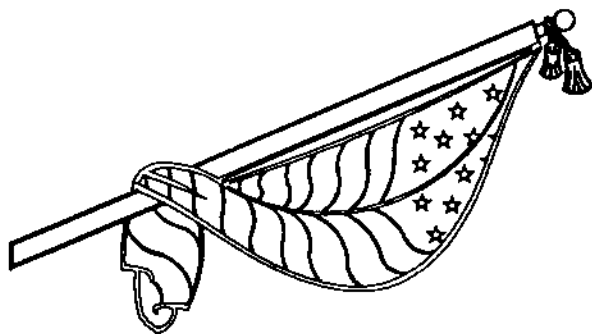

NICHOLSON MONUMENT CO
CLINTON OK

STD5M263.CMP

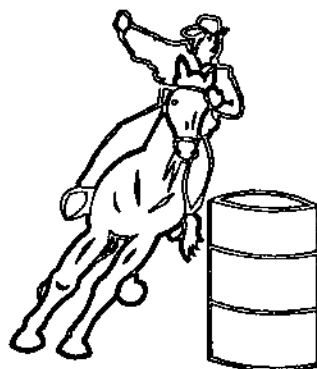

NICHOLSON MONUMENT CO
CLINTON OK

STD5M264.CMP

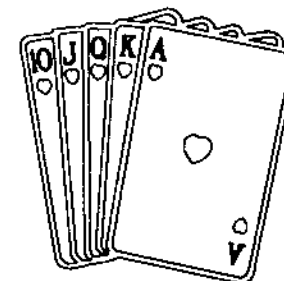

CARON GRANITE CO
PAWTUCKET RI

STD5M265.CMP

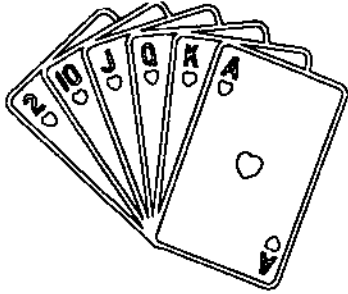

CARON GRANITE CO
PAWTUCKET RI

STD5M266 .CMP

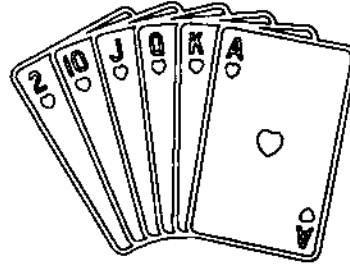

CARON GRANITE CO
PAWTUCKET RI

STD5M267 .CMP



CARON GRANITE CO
PAWTUCKET RI

STD5M268 .CMP

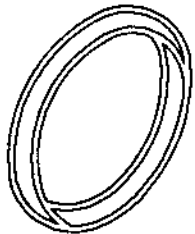

CARON GRANITE CO
PAWTUCKET RI

STD5M269 .CMP

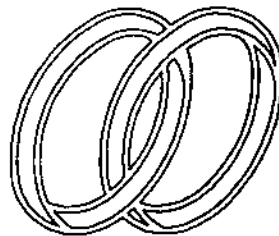

CARON GRANITE CO
PAWTUCKET RI

STD5M270 .CMP



CARON GRANITE CO
PAWTUCKET RI

STD5M271 .CMP





CARON GRANITE CO
PAWTUCKET RI

STD5M272.CMP

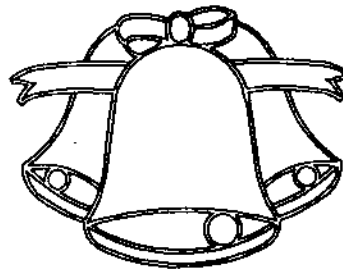

CARON GRANITE CO
PAWTUCKET RI

STD5M273.CMP



CARON GRANITE CO
PAWTUCKET RI

STD5M274.CMP

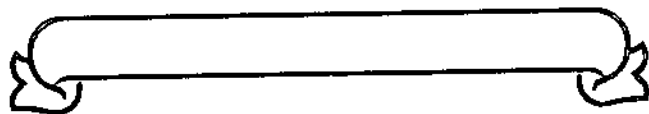

CARON GRANITE CO
PAWTUCKET RI

STD5M275.CMP

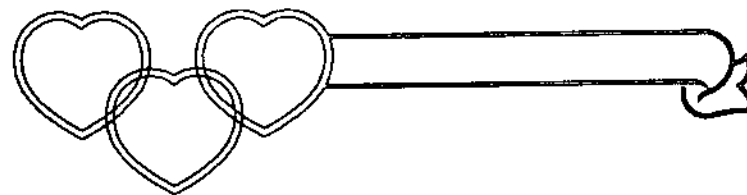

CARON GRANITE CO
PAWTUCKET RI

STD5M276.CMP

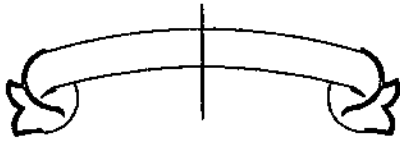

CARON GRANITE CO
PAWTUCKET RI

STD5M277.CMP

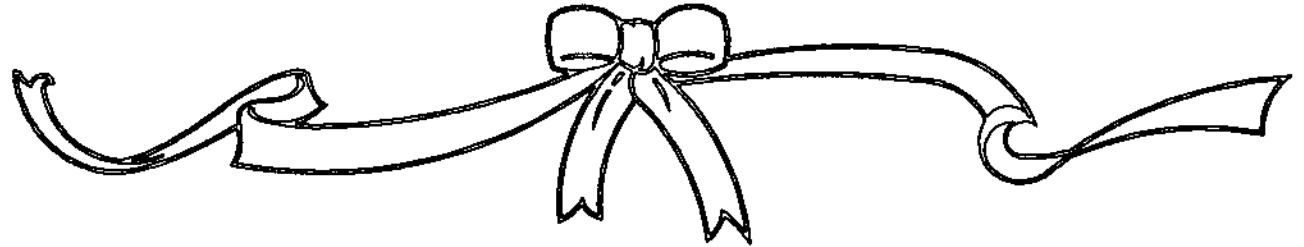

CARON GRANITE CO
PAWTUCKET RI

STD5M278.CMP



CARON GRANITE CO
PAWTUCKET RI

STD5M279.CMP



CARON GRANITE CO
PAWTUCKET RI

STD5M280.CMP



CARON GRANITE CO
PAWTUCKET RI

STD5M281.CMP





PLOUFF'S MONUMENT CO
ST. ALBANS VT

STD5M282.CMP



PHOENIXVILLE MEMORIAL WORKS
PHOENIXVILLE PA

STD5M283.CMP

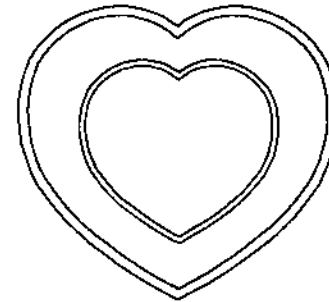

PHOENIXVILLE MEMORIAL WORKS
PHOENIXVILLE PA

STD5M284.CMP

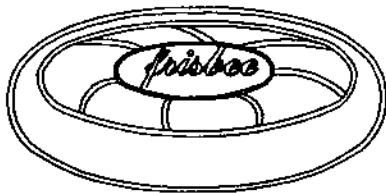

PHOENIXVILLE MEMORIAL WORKS
PHOENIXVILLE PA

STD5M285.CMP

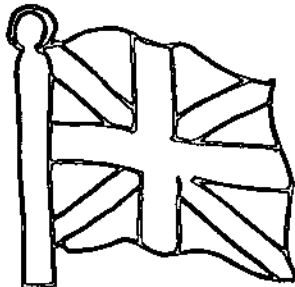

PHOENIXVILLE MEMORIAL WORKS
PHOENIXVILLE PA

STD5M286.CMP

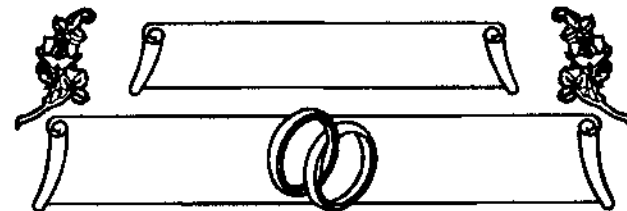

MCGEE MONUMENT
MORRILTON AR

STD5M287.CMP

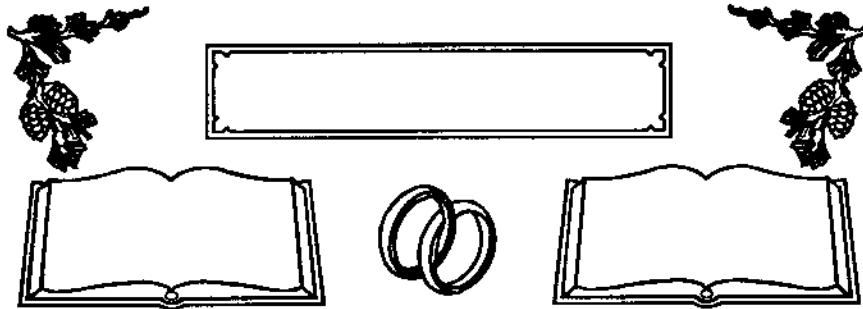

MCGEE MONUMENT CO
MORRILTON AR

STD5M288.CMP

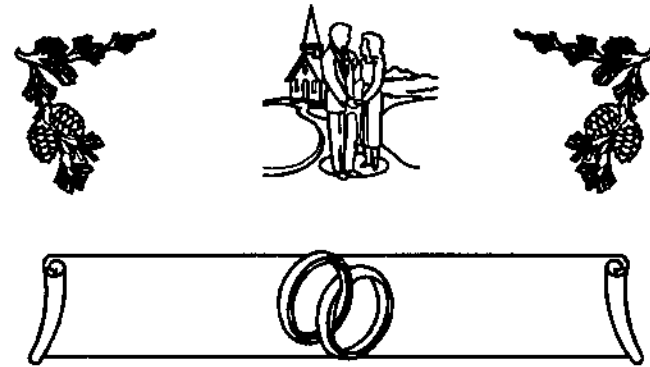

MCGEE MONUMENT CO
MORRILTON AR

STD5M289.CMP

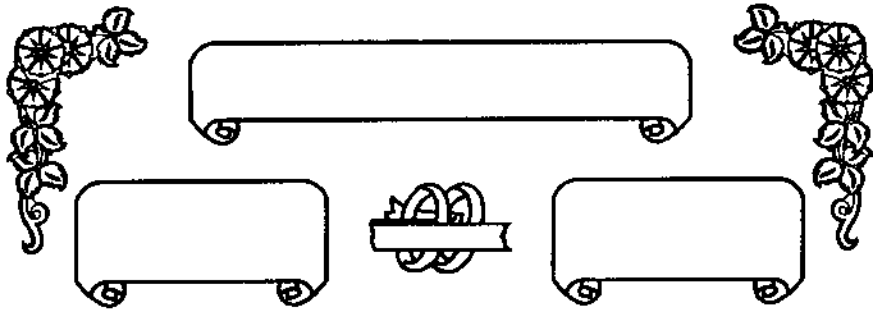

MCGEE MONUMENT CO
MORRILTON AR

STD5M290.CMP

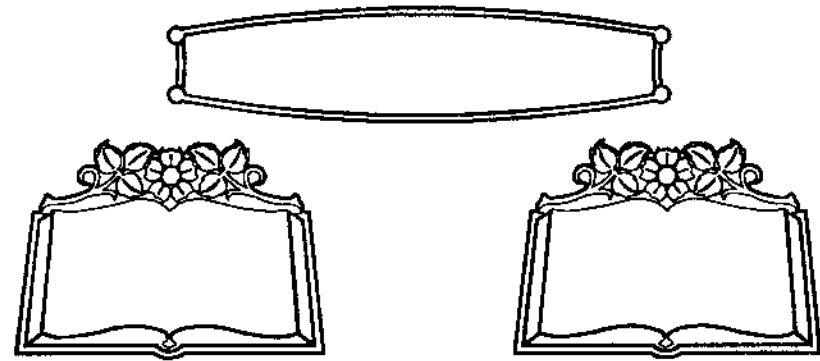

MCGEE MONUMENT CO
MORRILTON AR

STD5M291.CMP



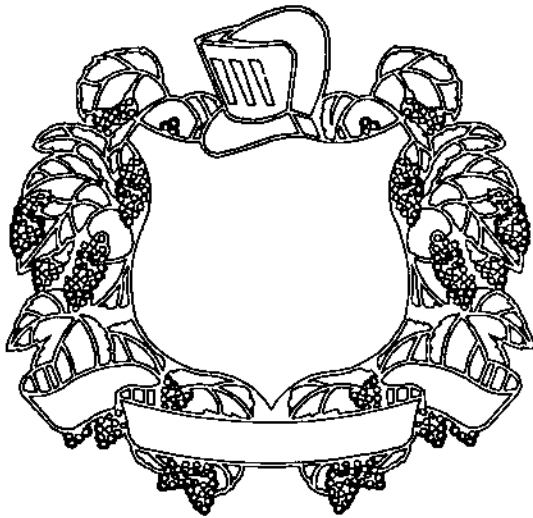

MC GEE MONUMENT CO
MORRILTON AR

STD5M292 .CMP



KEITH MONUMENT CO
BOWLING GREEN KY

STD5M293 .CMP

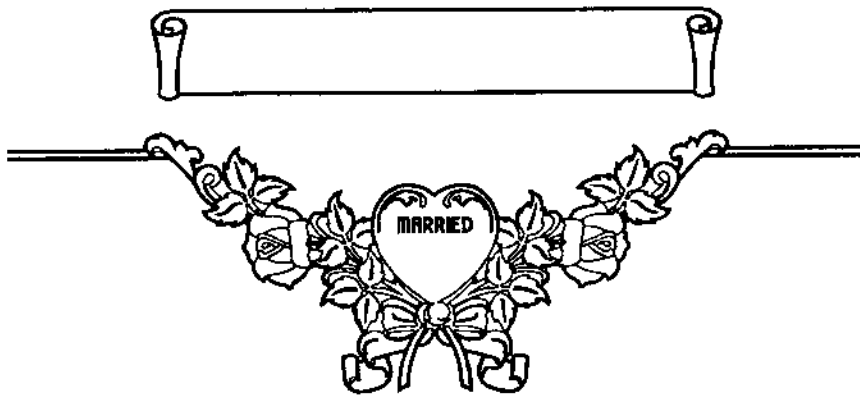

KEITH MONUMENT CO
BOWLING GREEN KY

STD5M294 .CMP

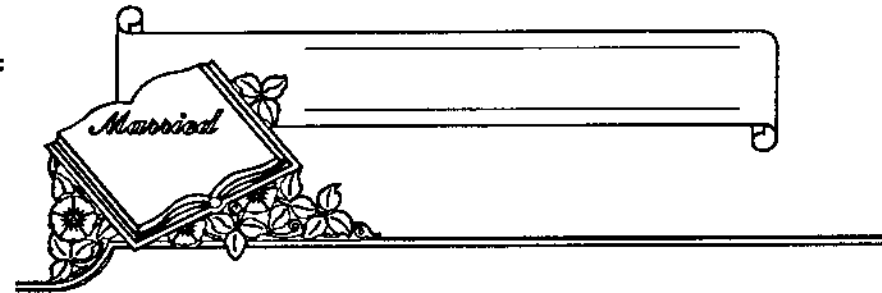

KEITH MONUMENT CO
BOWLING GREEN KY

STD5M295 .CMP

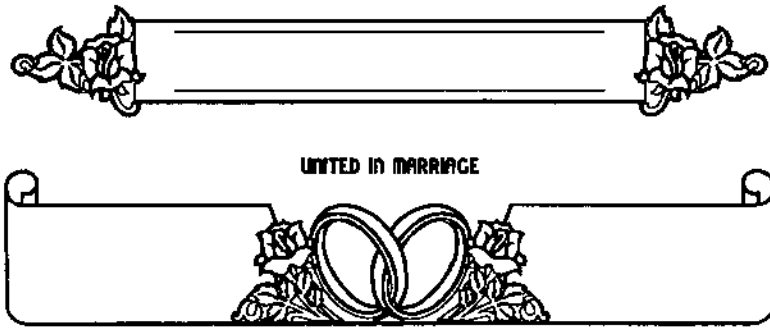

KEITH MONUMENT CO
BOWLING GREEN KY

STD5M296 .CMP

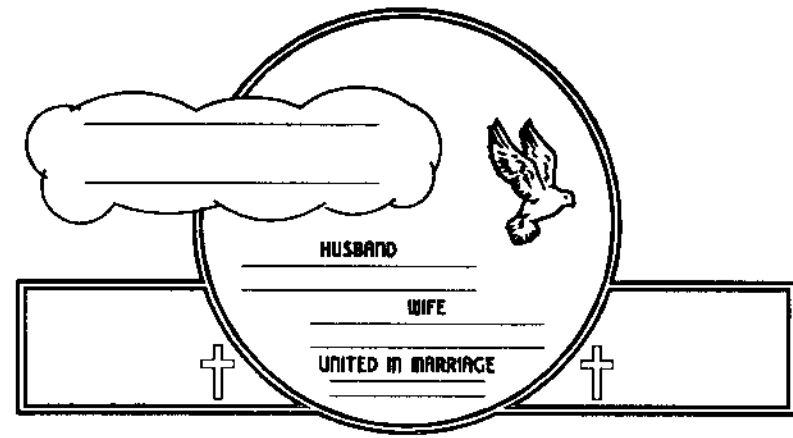

KEITH MONUMENT CO
BOWLING GREEN KY

STD5M297 .CMP

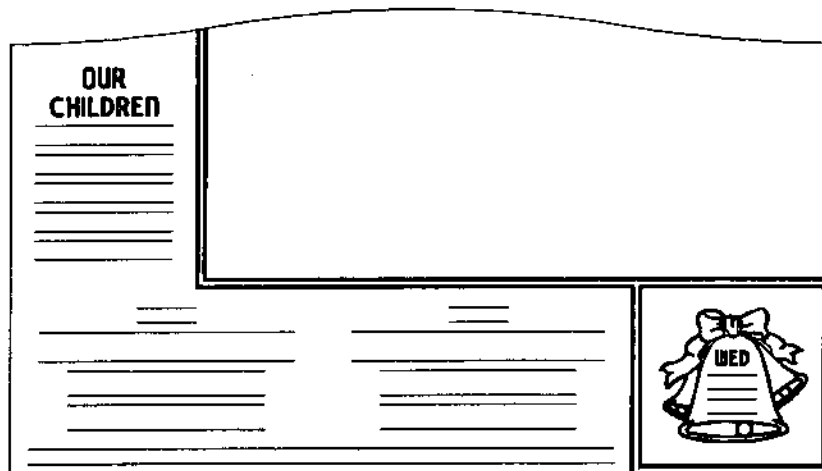

KEITH MONUMENT CO
BOWLING GREEN KY

STD5M298 .CMP

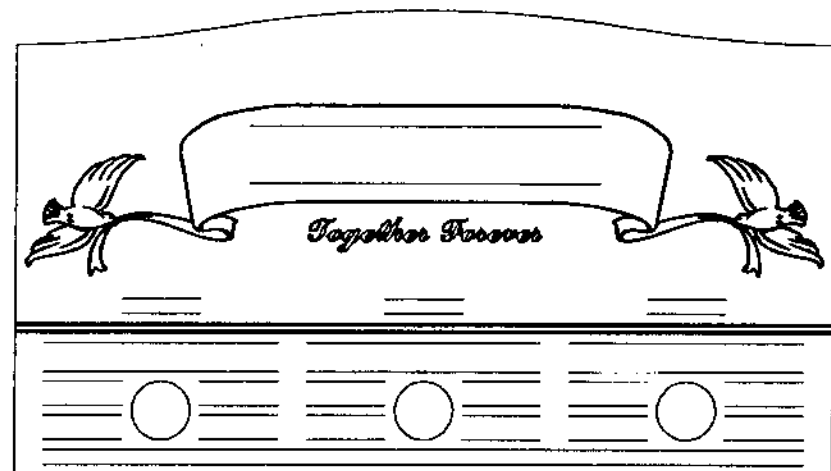

KEITH MONUMENT CO
BOWLING GREEN KY

STD5M299 .CMP

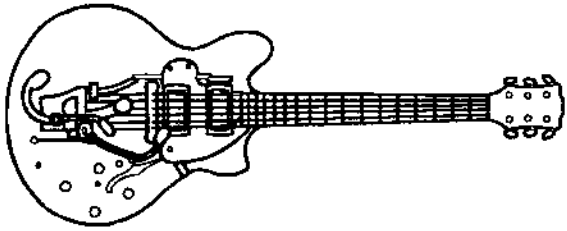

PEEBLES MONUMENT CO
PEEBLES OH

STD5M300 .CMP

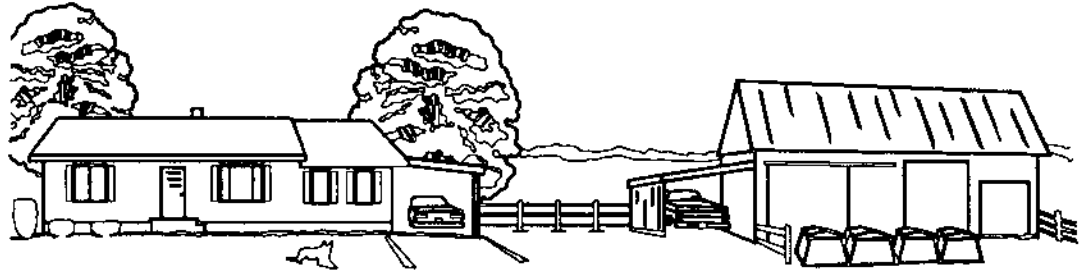

PEEBLES MONUMENT CO
PEEBLES OH

STD5M301 .CMP

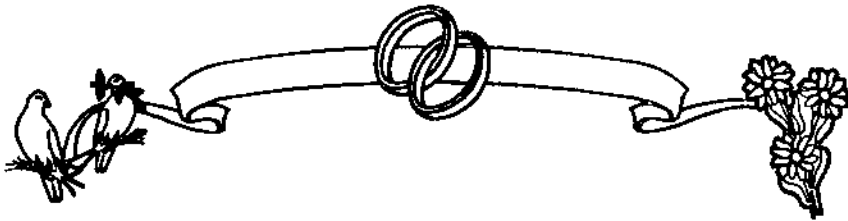

PEEBLES MONUMENT CO
PEEBLES OH

STD5M302 .CMP

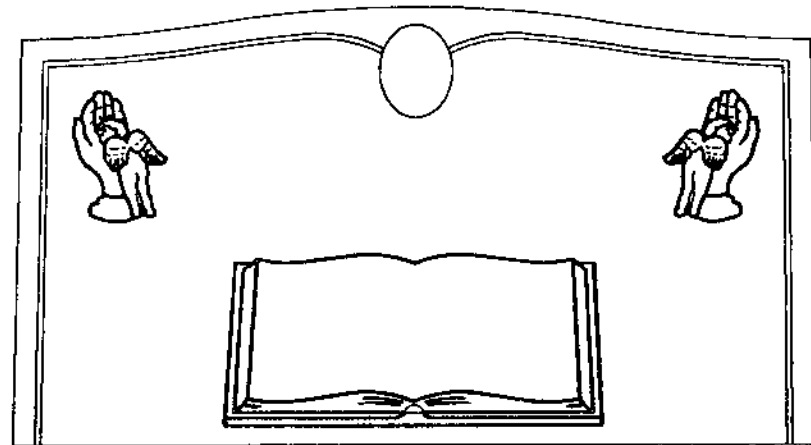

PEEBLES MONUMENT CO
PEEBLES OH

STD5M303 .CMP



PEEBLES MONUMENT CO
PEEBLES OH

STD5M304 .CMP

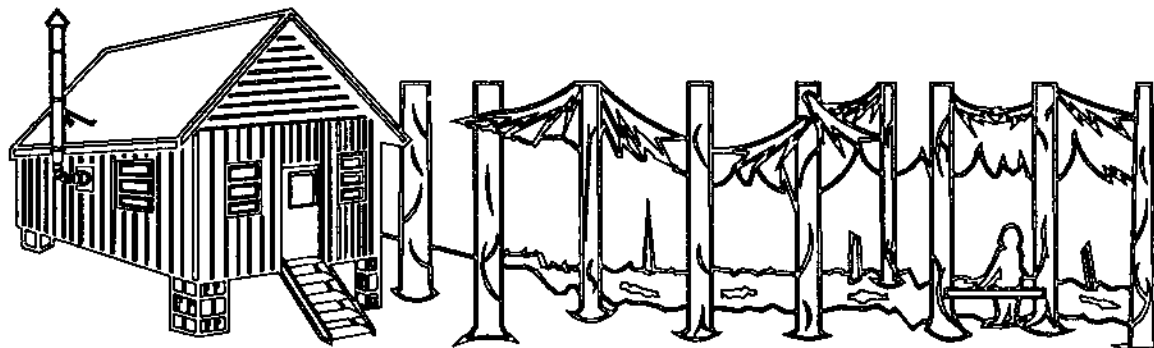

CHERRY VALLEY MEMORIALS
CHERRY VALLEY NY

STD5M305 .CMP

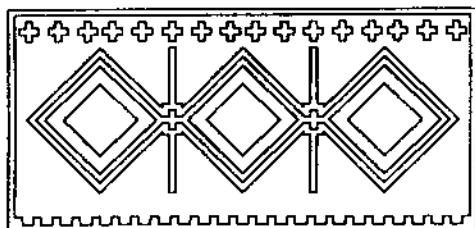

CHERRY VALLEY MEMORIALS
CHERRY VALLEY NY

STD5M306 .CMP

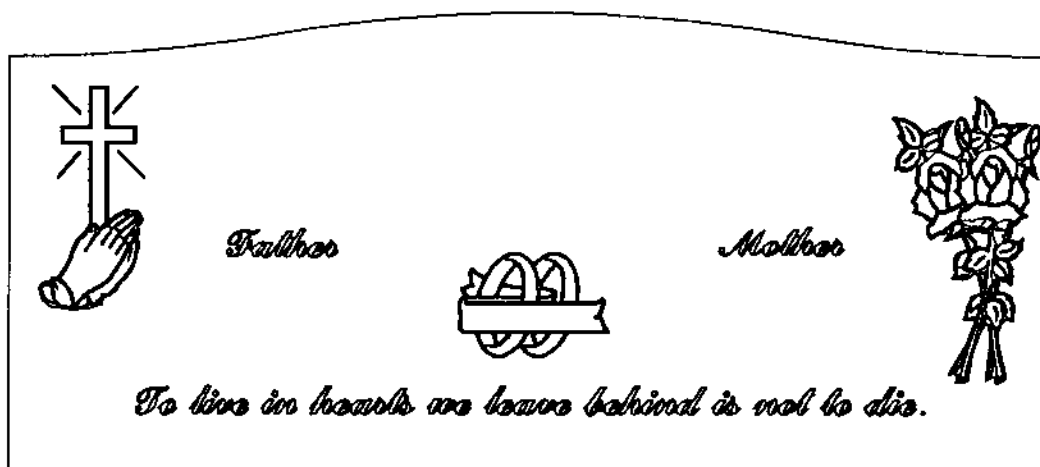

HENRY OLSON MEMORIALS
LOVES PARK IL

STD5M307 .CMP

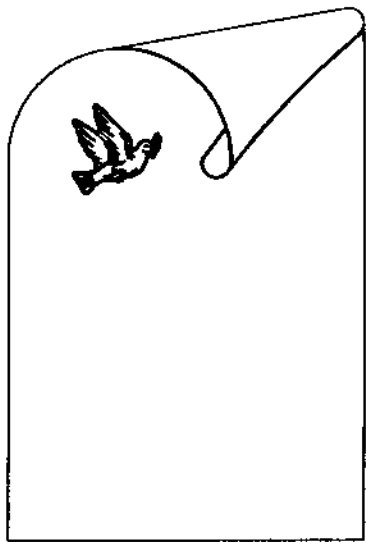

ROCK OF AGES CANADA
BEEBE QUEBEC CANADA

STD5M308 .CMP



ROCK OF AGES CANADA
BEEBE QUEBEC CANADA

STD5M309 .CMP

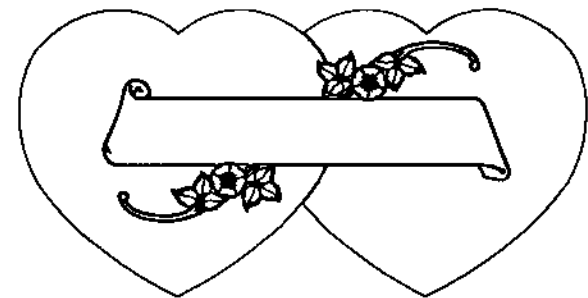

ROCK OF AGES CANADA
BEEBE QUEBEC CANADA

STD5M310 .CMP



3 5/8 *
3 7/8 *
TULSA MONUMENT CO.
TULSA OK
STD5N002 .CMP

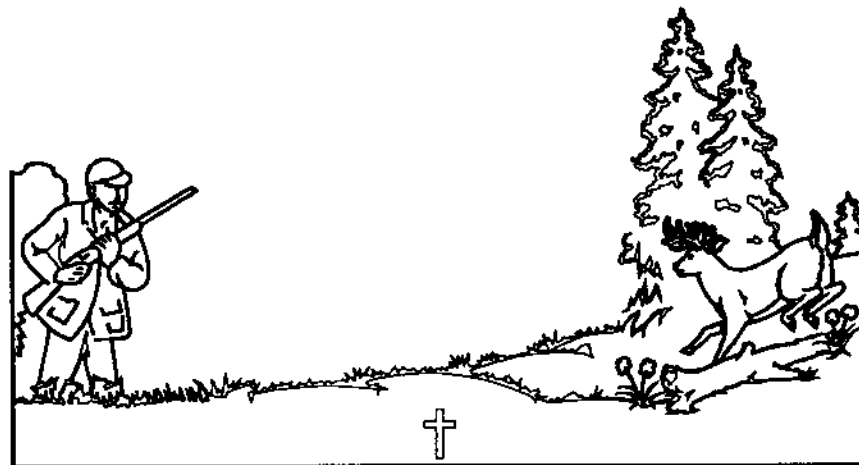

SANDZIMIER MEMORIALS
SCOTTDALE PA

STD5N003 .CMP

STAFFORD MONUMENT CO.
WHITBY ONTARIO STD5N001 .CMP



SANDZIMIER MEMORIALS
SCOTTDALE PA STD5N004 .CMP



STANDARD GRANITE
ELBERTON GA



STD5N005 .CMP



DAKOTA MONUMENT
FARGO ND STD5N006 .CMP

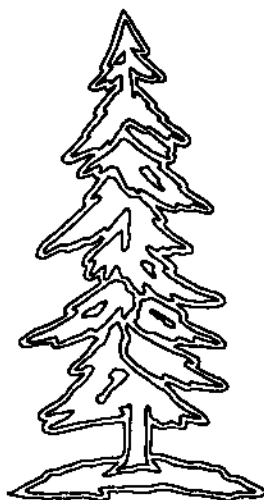

DAKOTA MONUMENT
FARGO ND STD5N007 .CMP

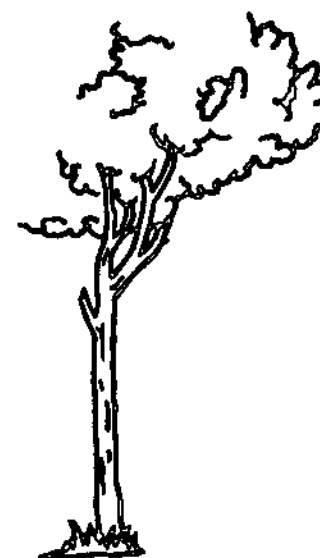

DAKOTA MONUMENT
FARGO ND STD5N008 .CMP

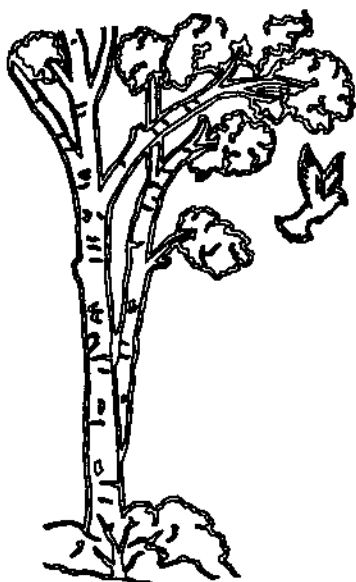

DAKOTA MONUMENT
FARGO ND STD5N009 .CMP

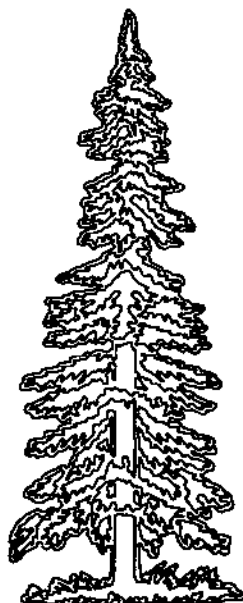

DAKOTA MONUMENT
FARGO ND STD5N010 .CMP



DAKOTA MONUMENT
FARGO ND STD5N011 .CMP



DAKOTA MONUMENT
FARGO ND
STD5N012.CMP



DAKOTA MONUMENT
FARGO ND
STD5N013.CMP

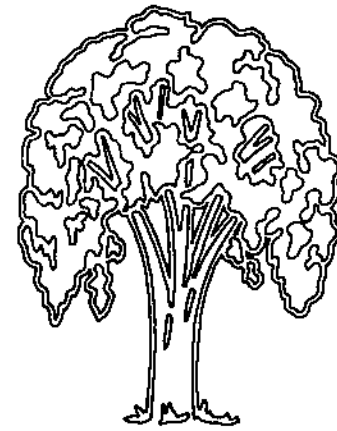

DAKOTA MONUMENT
FARGO ND
STD5N014.CMP

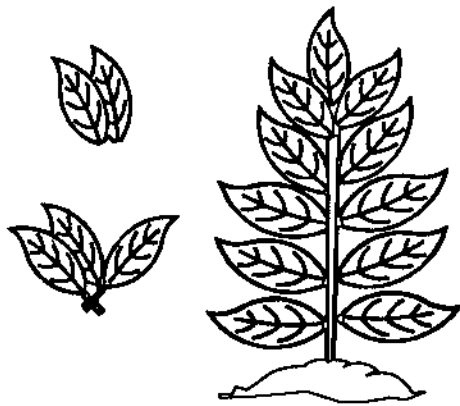

N.C. MARBLE & GRANITE
CLINTON NC
STD5N015.CMP



AMITE MARBLE & GRANITE
AMITE LA
STD5N016.CMP

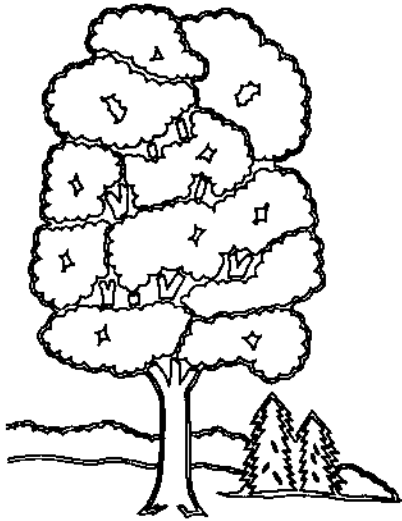

EDWIN F. NICKOL
VERSAILLES OH
STD5N017.CMP

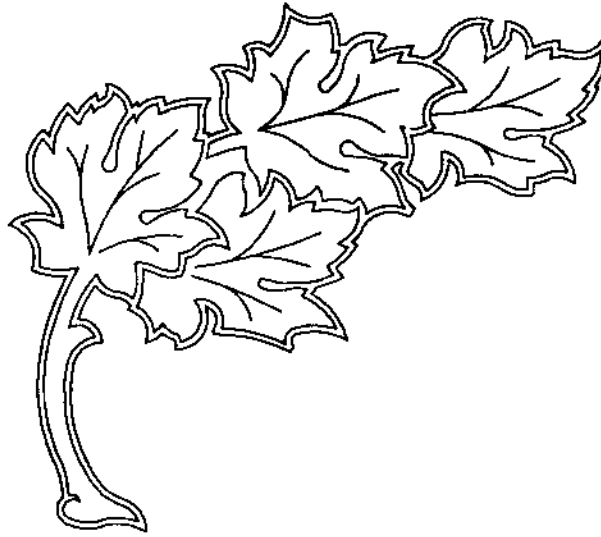

EDWIN F. NICKOL
VERSAILLES OH
STD5N018.CMP

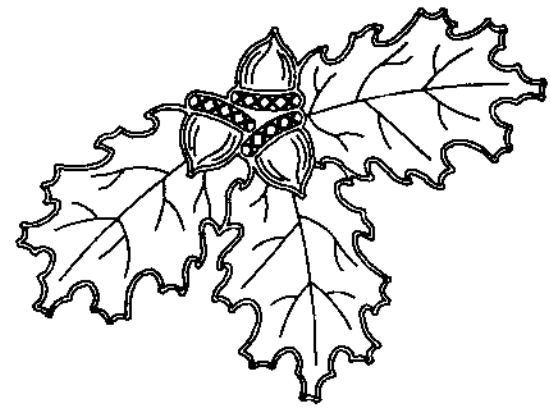

GALLAGHER MONUMENTS
MALAGA OH
STD5N019.CMP

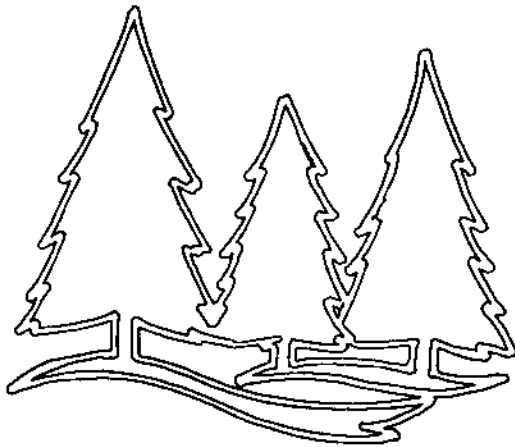

STATEWIDE MEMORIALS
BRUNSWICK ME
STD5N020.CMP

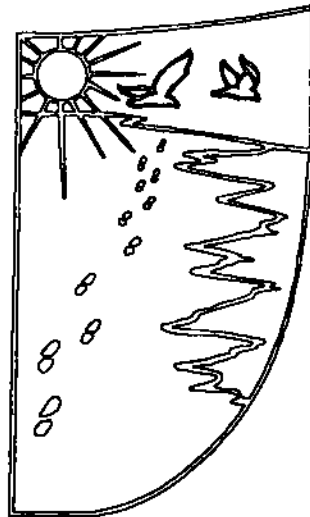

STATEWIDE MEMORIALS
BRUNSWICK ME
STD5N021.CMP



STATEWIDE MEMORIALS
BRUNSWICK ME
STD5N022.CMP



ST. CHARLES MEMORIAL WORKS
ST. CHARLES IL

STD5N023.CMP

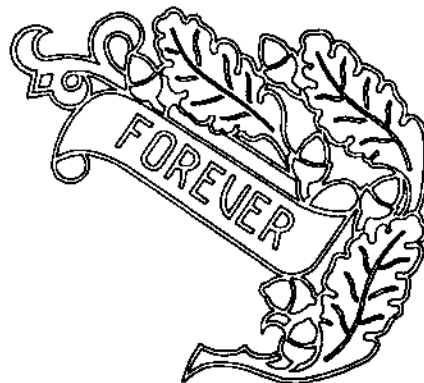

ST. CHARLES MEMORIAL WORKS
ST. CHARLES IL

STD5N024.CMP



MILACEK MONUMENT CO
OMAHA NE

STD5N025.CMP



MILACEK MONUMENT CO
OMAHA NE

STD5N026.CMP

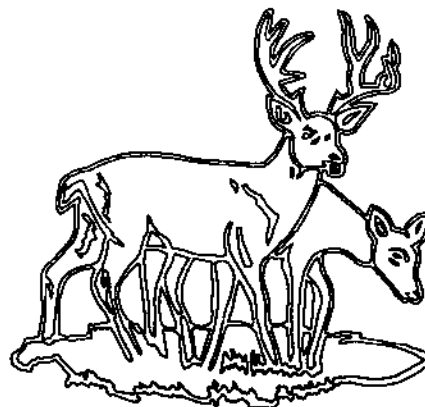

MILACEK MONUMENT CO
OMAHA NE

STD5N027.CMP

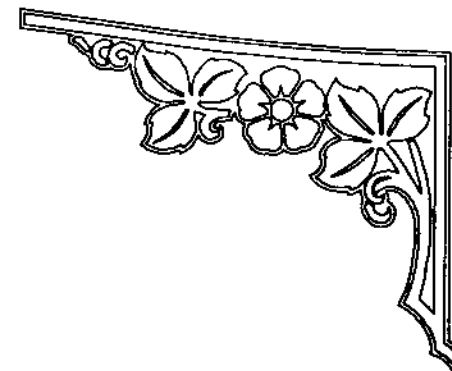

MILACEK MONUMENT CO
OMAHA NE

STD5N028.CMP

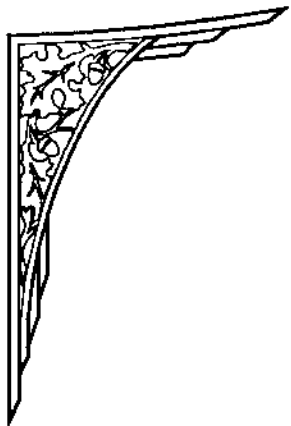

MILLIGAN MEMORIALS
COSHOCOTON OH

STD5N029.CMP



QUALITY-CUT MONUMENTAL DESIGNS
ELBERTON GA

(PALM TREES) STD5N030.CMP

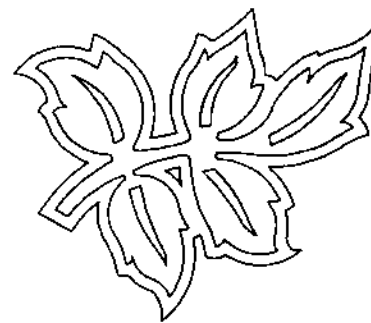

SEBASTIANO AIELLO MONUMENTS INC.
MONTREAL QUEBEC CANADA

STD5N031.CMP

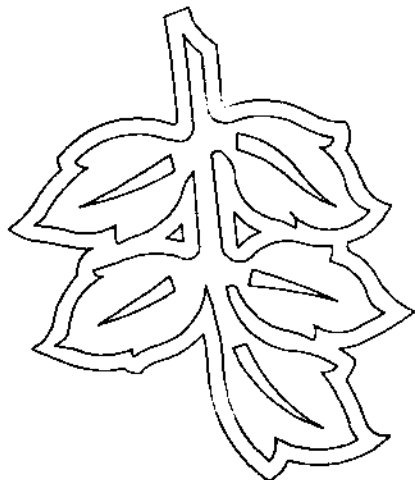

SEBASTIANO AIELLO MONUMENTS INC.
MONTREAL QUEBEC CANADA

STD5N032.CMP

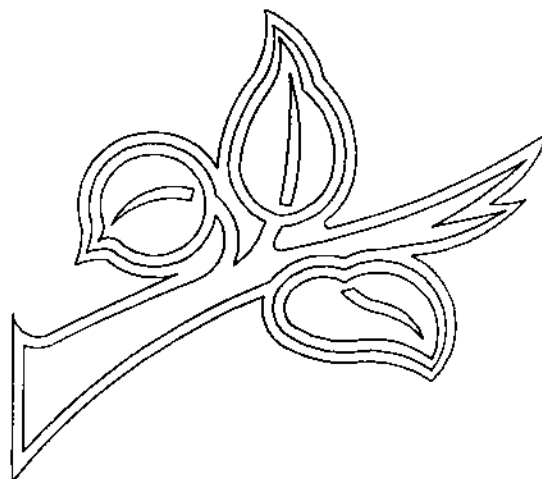

SEBASTIANO AIELLO MONUMENTS INC.
MONTREAL QUEBEC CANADA

STD5N033.CMP



RMG STONE PRODUCTS
CASTLETON VT

STD5N034.CMP

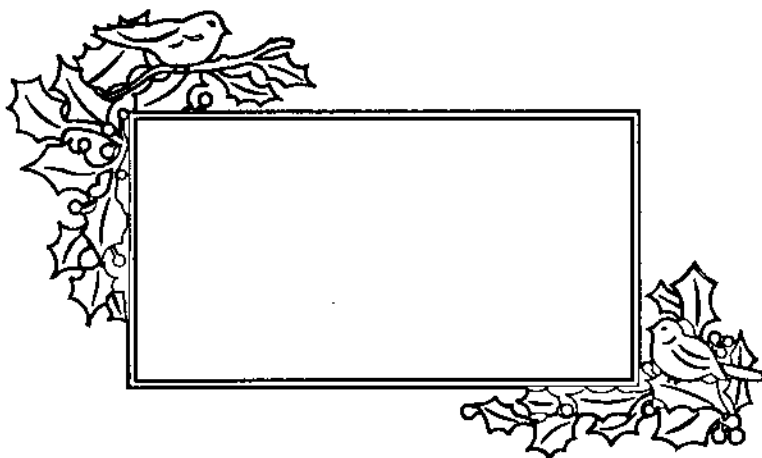

RMG STONE PRODUCTS
CASTLETON VT

STD5N035.CMP



LONGSTRETH MEMORIALS
GALION OH

STD5N036.CMP



CROWN MONUMENT
WARREN OH

STD5N037.CMP

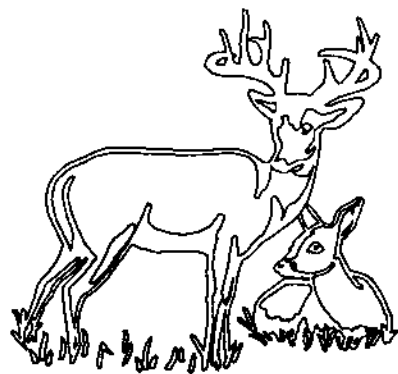

CROWN MONUMENT
WARREN OH

STD5N038.CMP



CAPITOL HILL MONUMENT
OKLAHOMA CITY OK

STD5N039.CMP



MILWAUKEE MEMORIAL CO
MILWAUKEE WI

STD5N040.CMP



HUTCH CUSTOM DESIGN
GROVETON NH

STD5N041.CMP



HUTCH CUSTOM DESIGN
GROVETON NH

STD5N042.CMP



MOORE MONUMENT CO
CHILLICOTHE MO

STD5N043.CMP

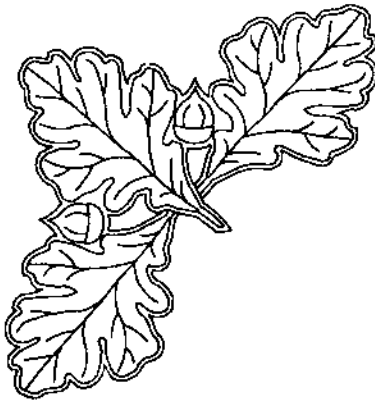

MOORE MONUMENT CO
CHILLICOTHE MO

STD5N044.CMP

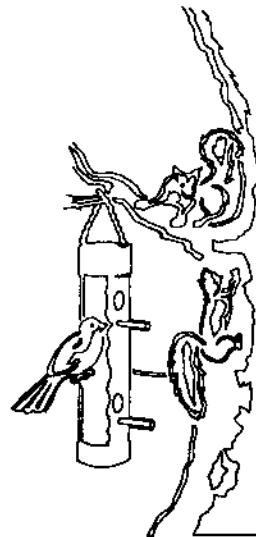

MOORE MONUMENT CO
CHILLICOTHE MO

STD5N045.CMP



PEORIA MONUMENT CO
PEORIA IL

STD5N046.CMP

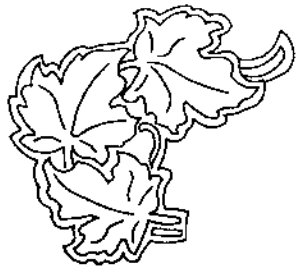

PEORIA MONUMENT CO
PEORIA IL

STD5N047.CMP

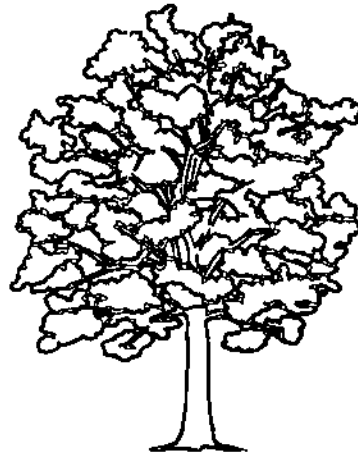

SOUTH BEND MONUMENT WORKS
SOUTH BEND IN

STD5N048.CMP

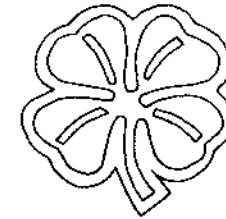

BARRE MEMORIALS
HYDE PARK NY

STD5N040.CMP

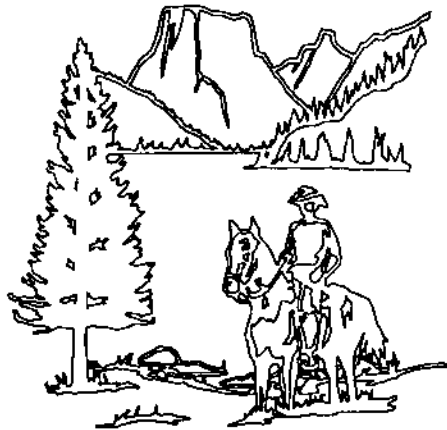

BEESELY MONUMENT CO
PROVO UT

STD5N050.CMP

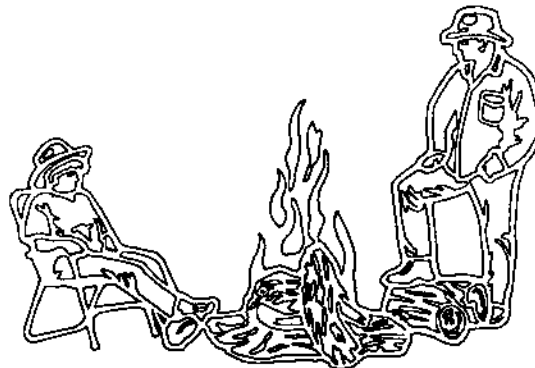

BEESELY MONUMENT CO
PROVO UT

STD5N051.CMP



KIRKPATRICK & O'BRINE LTD
FONTHILL ONTARIO CANADA

STD5N052.CMP



WOODSIDE GRANITE
ALBION NY

STD5N053 .CMP



LEXINGTON GRANITE CO
LEXINGTON KY

STD5N054 .CMP

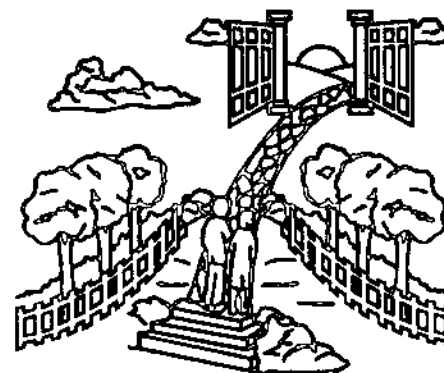

LEXINGTON GRANITE CO
LEXINGTON KY

STD5N055 .CMP



BROWN MONUMENT
LOGAN UT

STD5N056 .CMP

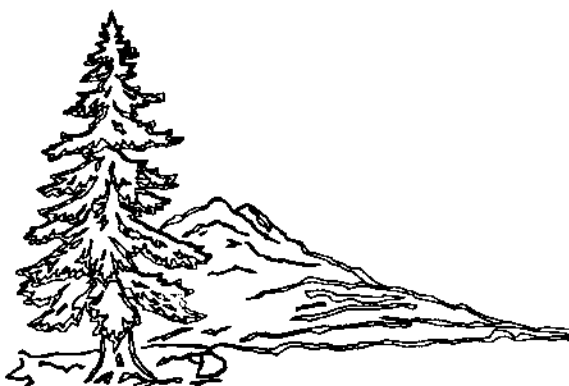

BROWN MONUMENT
LOGAN UT

STD5N057 .CMP

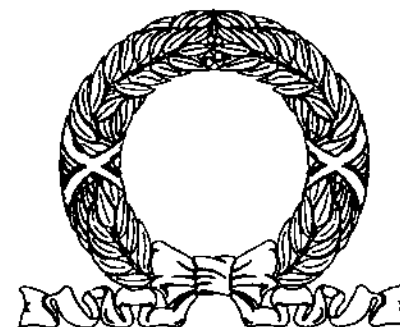

MASTERCRAFT MEMORIALS
RICHMOND IN

STD5N058 .CMP





MASTERCRAFT MEMORIALS
RICHMOND IN

STD5N059.CMP



GRANITE APPALACHES
LAC DROLET QUEBEC CANADA



MASTERCRAFT MEMORIALS
RICHMOND IN

STD5N060.CMP

STD5N061.CMP



GRANITE APPALACHES
LAC DROLET QUEBEC CANADA

STD5N062.CMP

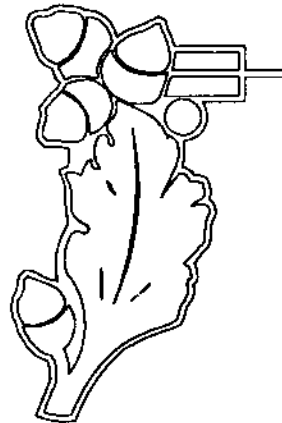

FOREST PARK MEMORIALS
HOUSTON TX

STD5N063.CMP

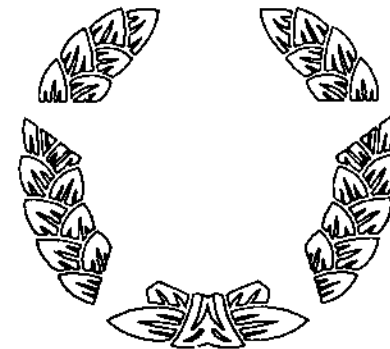

SCHAEFER MONUMENT CO
ST. LOUIS MO

STD5N064.CMP



SCHAEFER MONUMENT CO
ST. LOUIS MO

STD5N065.CMP

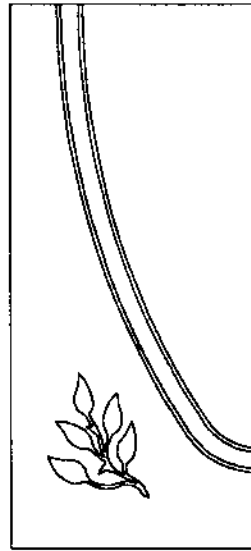

SCHAEFER MONUMENT CO
ST. LOUIS MO

STD5N066.CMP

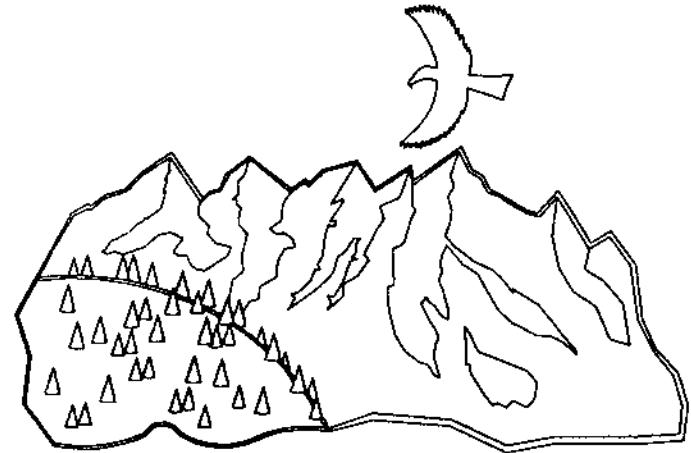

SCHAEFER MONUMENT CO
ST. LOUIS MO

STD5N067.CMP



SCHAEFER MONUMENT CO
ST. LOUIS MO

STD5N068.CMP



TROY MARBLE & GRANITE WORKS
TROY PA

STD5N069.CMP

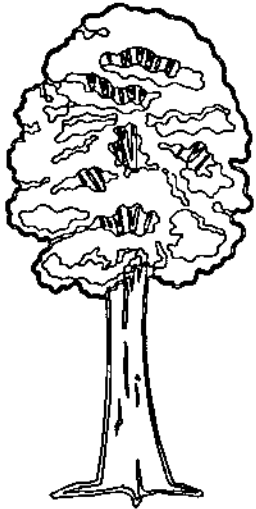

L. J. SERVICES
CHERRY VALLEY NY

STD5N070.CMP

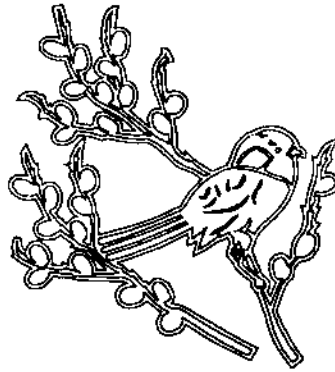

L. J. SERVICES
CHERRY VALLEY NY

STD5N071.CMP

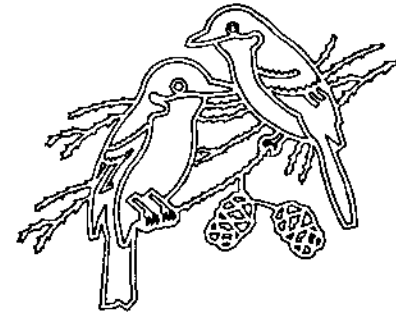

L. J. SERVICES
CHERRY VALLEY NY

STD5N072.CMP

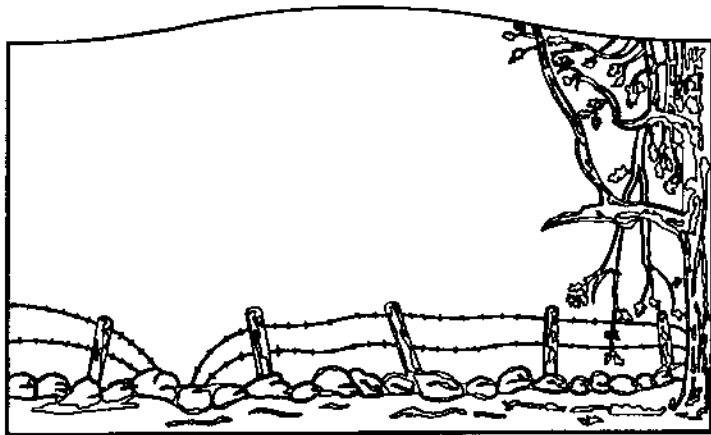

L. J. SERVICES
CHERRY VALLEY NY

STD5N073.CMP

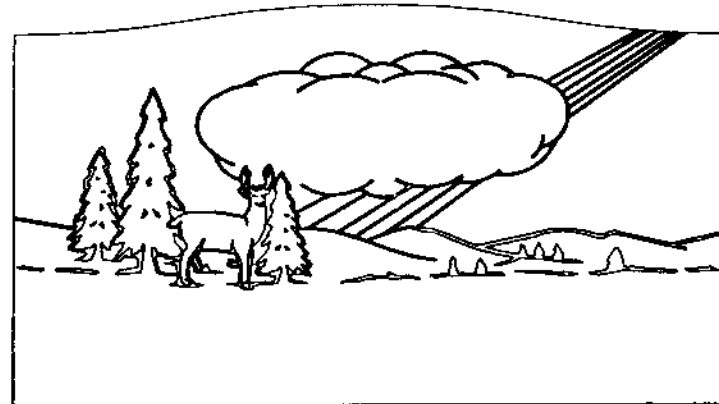

L. J. SERVICES
CHERRY VALLEY NY

STD5N074.CMP

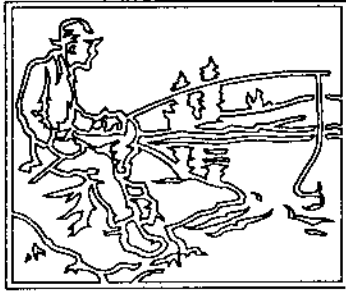

VISALIA GRANITE & MARBLE WORKS
VISALIA CA

STD5N075.CMP

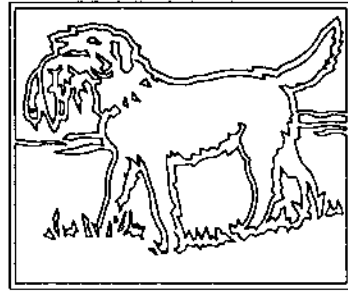

VISALIA GRANITE & MARBLE WORKS
VISALIA CA

STD5N076.CMP

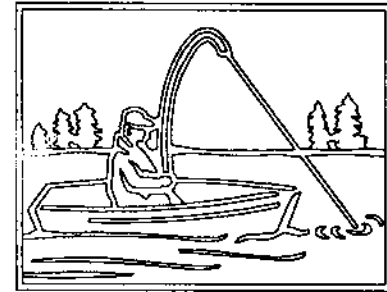

VISALIA GRANITE & MARBLE WORKS
VISALIA CA

STD5N077.CMP



ROCK OF AGES CANADA
BEEBE QUEBEC CANADA

STD5N078.CMP

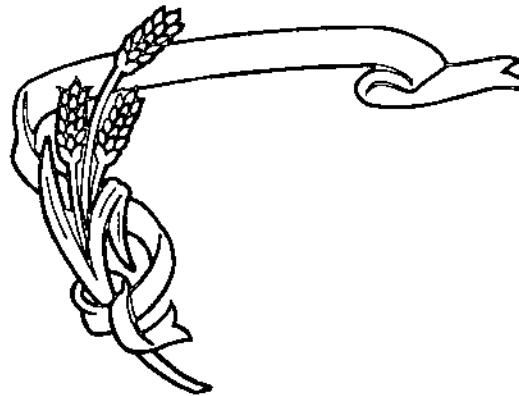

ROCK OF AGES CANADA
BEEBE QUEBEC CANADA

STD5N079.CMP

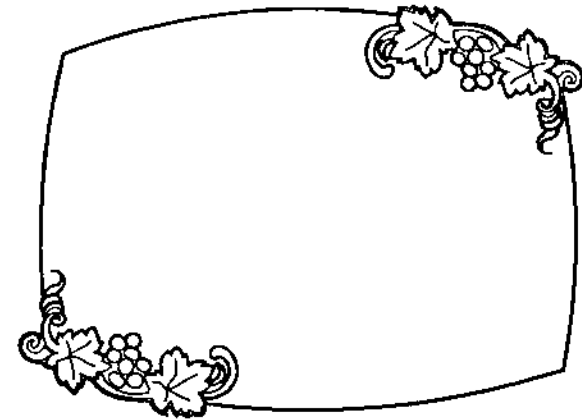

ROCK OF AGES CANADA
BEEBE QUEBEC CANADA

STD5N080.CMP



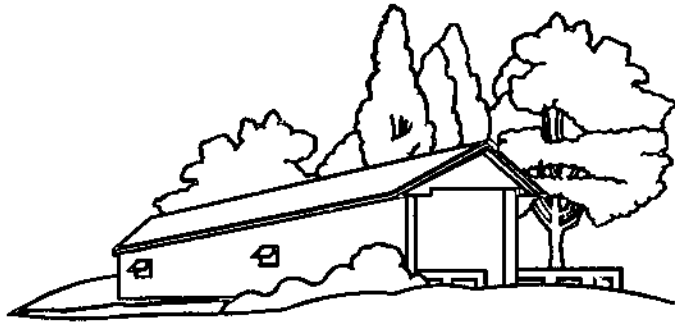

LANDMARK GRANITE CO
ELBERTON GA

STD5N081.CMP



GRIMES BROS. GRANITE CO
ELBERTON GA

STD5N082.CMP

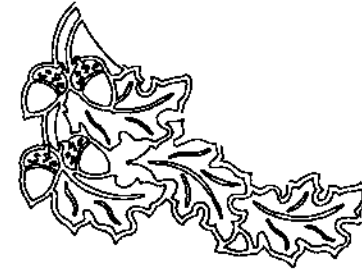

GRIMES BROS. GRANITE CO
ELBERTON GA

STD5N083.CMP



GRIMES BROS. GRANITE CO
ELBERTON GA

STD5N084.CMP

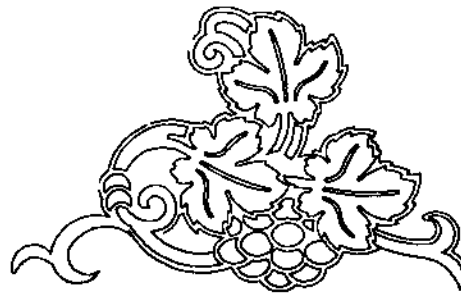

GRIMES BROS. GRANITE CO
ELBERTON GA

STD5N085.CMP

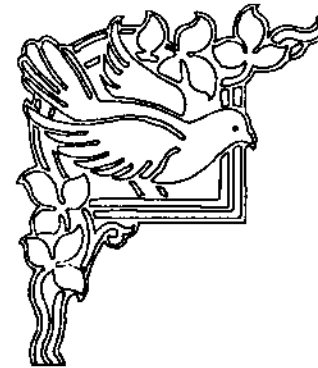

BRACOLONI CUSTOM MEMORIALS
TRENTON NJ

STD5N086.CMP

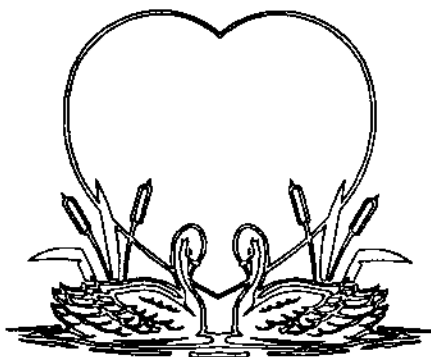

ART STONE CO
ROCK ISLAND IL

STD5N087.CMP



NICHOLSON MONUMENT CO
CLINTON OK

STD5N088.CMP



CARON GRANITE CO
PAWTUCKET RI

SDT5N089.CMP



OREGON GRANITE CO
MEDFORD OR

STD5N090.CMP



OREGON GRANITE CO
MEDFORD OR

STD5N091.CMP



BAILEY MONUMENT CO
WAYCROSS GA

STD5F188.CMP



BAILEY MONUMENT CO
WAYCROSS GA

STD5F189.CMP

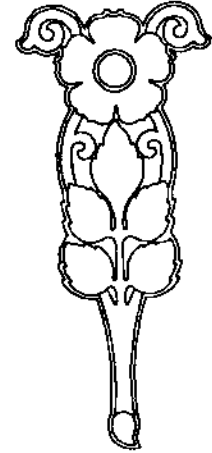

BAILEY MONUMENT CO
WAYCROSS GA

STD5F190.CMP

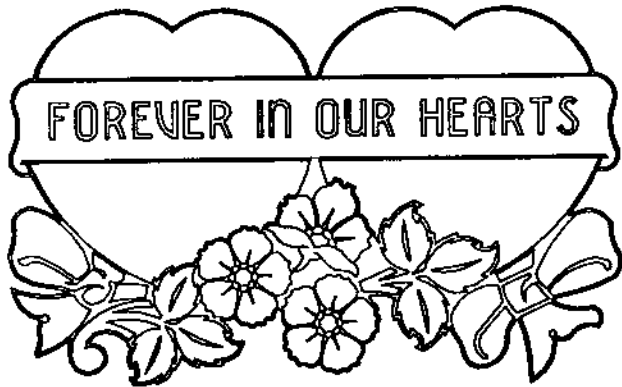

L. J. SERVICES
CHERRY VALLEY NY

STD5F191.CMP



L. J. SERVICES
CHERRY VALLEY NY

STD5F192.CMP

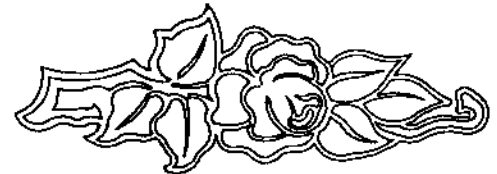

VISALIA GRANITE & MARBLE WORKS
VISALIA CA

STD5F193.CMP

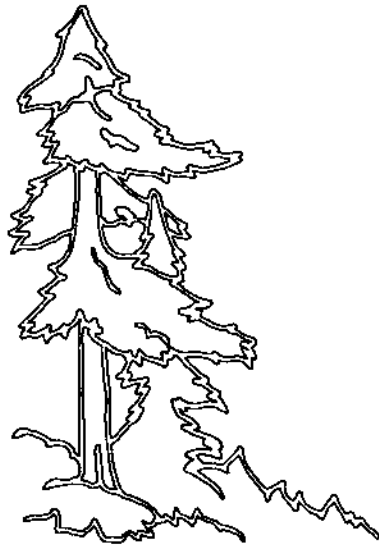

OREGON GRANITE CO
MEDFORD OR

STD5N092.CMP



OREGON GRANITE CO
MEDFORD OR

STD5N093.CMP

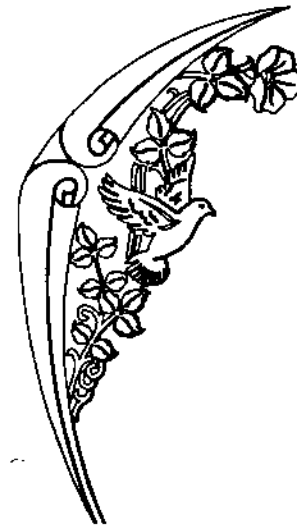

CHILDS & CHILDS GRANITE CO
ELBERTON GA

STD5N094.CMP

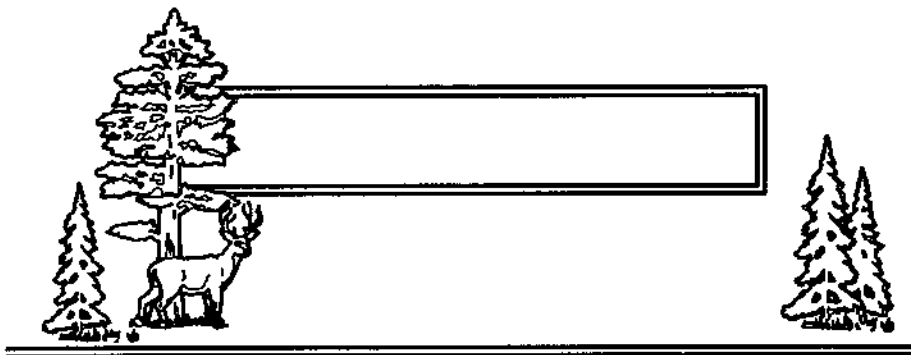

KEITH MONUMENT CO
BOWLING GREEN KY

STD5N095.CMP

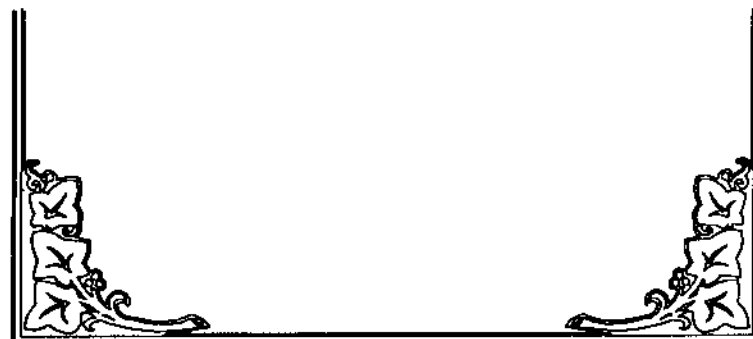

KEITH MONUMENT CO
BOWLING GREEN KY

STD5N096.CMP

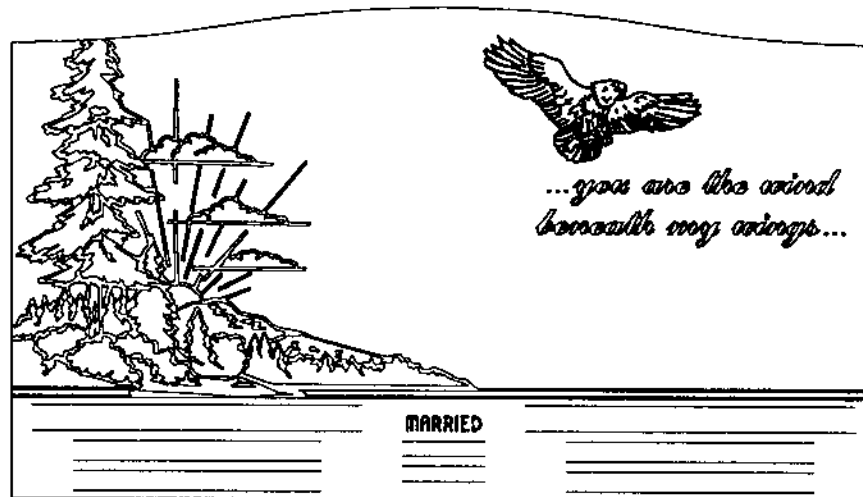

KEITH MONUMENT CO
BOWLING GREEN KY

STD5N097.CMP

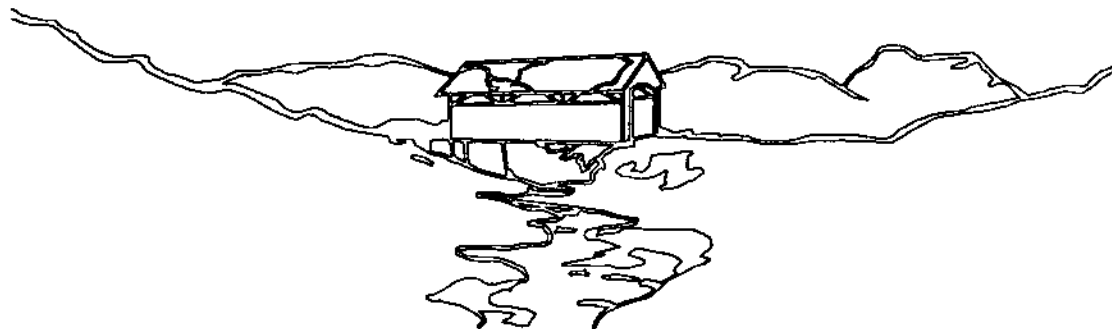

CHERRY VALLEY MEMORIALS
CHERRY VALLEY NY

STD5N098.CMP

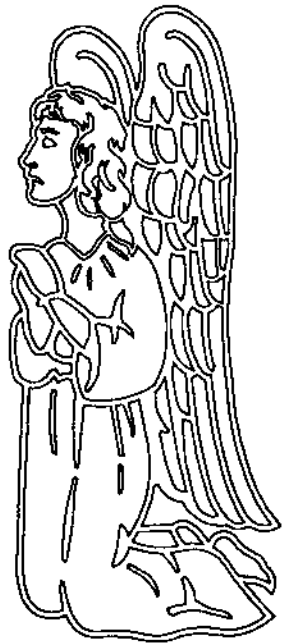

STAFFORD MONUMENT CO.
WHITBY ONTARIO STD5R001.CMP



STAFFORD MONUMENT CO.
WHITBY ONTARIO STD5R002.CMP

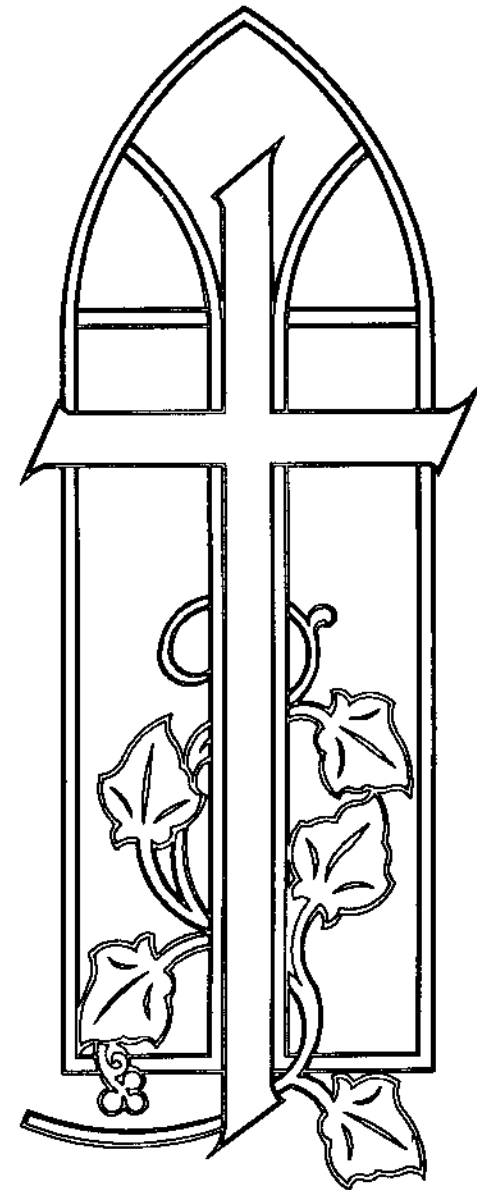

STAFFORD MONUMENT CO.
WHITBY ONTARIO STD5R003.CMP



STAFFORD MONUMENT CO.
WHITBY ONTARIO STD5R004.CMP

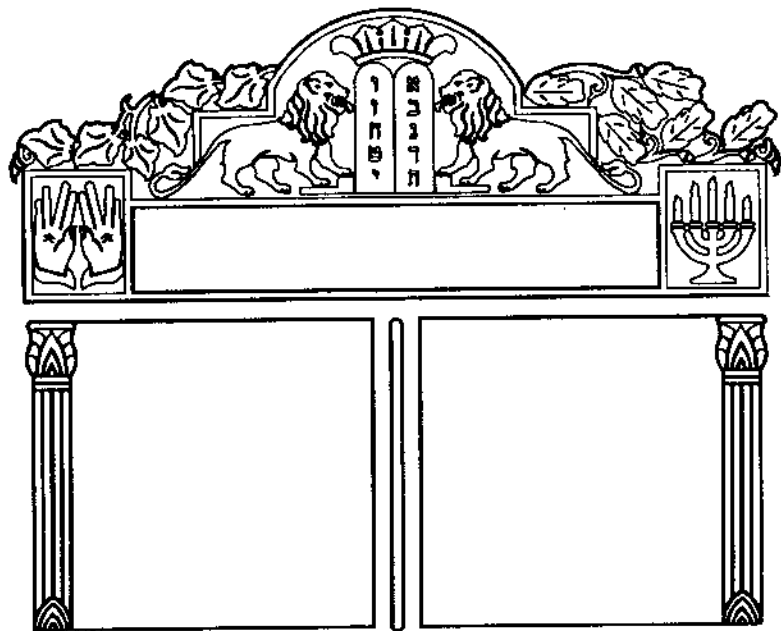

MEMORIAL GRANITE
WOODSIDE NY

STD5R005 .CMP

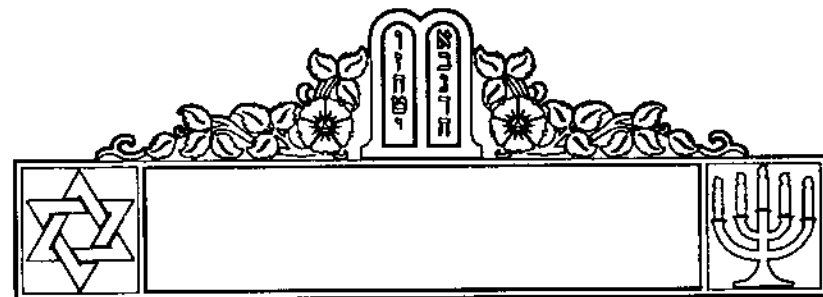

MEMORIAL GRANITE
WOODSIDE NY

STD5R006 .CMP

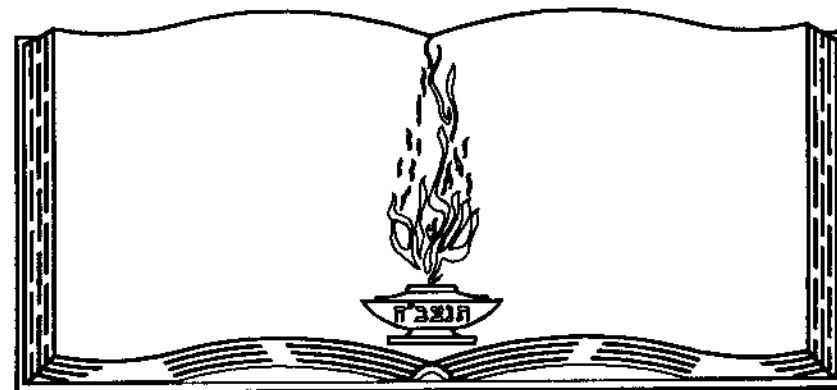

MEMORIAL GRANITE
WOODSIDE NY

STD5R007 .CMP

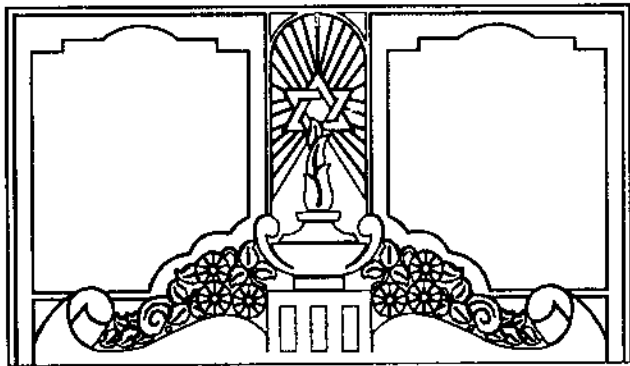

MEMORIAL GRANITE
WOODSIDE NY STD5R008 .CMP

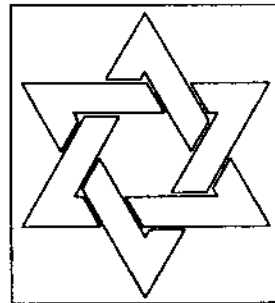

MEMORIAL GRANITE
WOODSIDE NY
STD5R009 .CMP

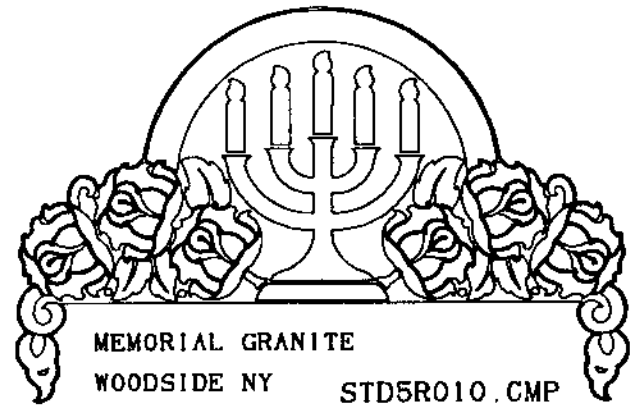

MEMORIAL GRANITE
WOODSIDE NY STD5R010 .CMP

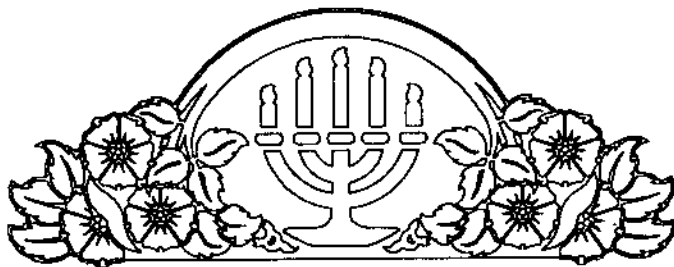

MEMORIAL GRANITE
WOODSIDE NY STD5R011 .CMP

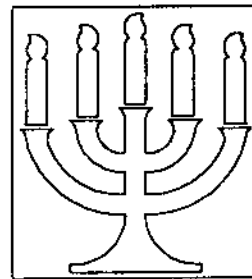

MEMORIAL GRANITE
WOODSIDE NY
STD5R012 .CMP

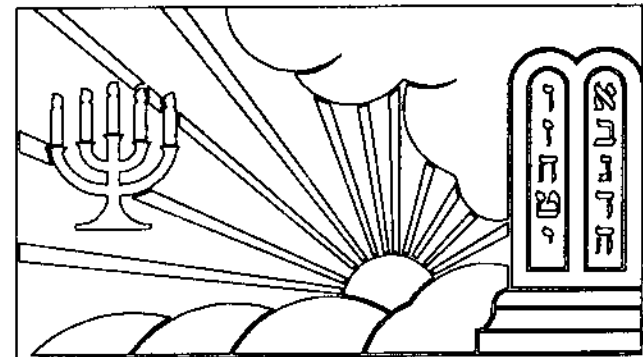

MEMORIAL GRANITE STD5R013 .CMP
WOODSIDE NY

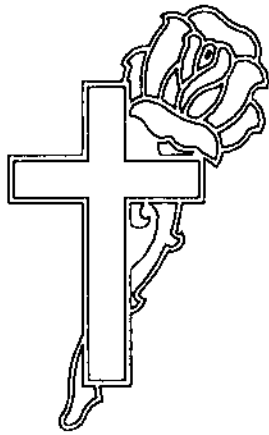

CAMDEN MONUMENT CO.
CAMDEN AR STD5R014.CMP



CAMDEN MONUMENT CO.
CAMDEN AR STD5R015.CMP

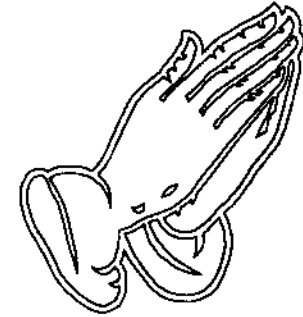

CAMDEN MONUMENT CO.
CAMDEN AR STD5R016.CMP

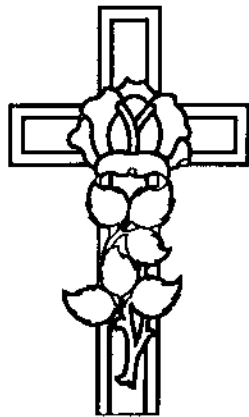

SANDZIMIER MEMORIALS
SCOTSDALE PA STD5R017.CMP



SANDZIMIER MEMORIALS
SCOTSDALE PA STD5R018.CMP

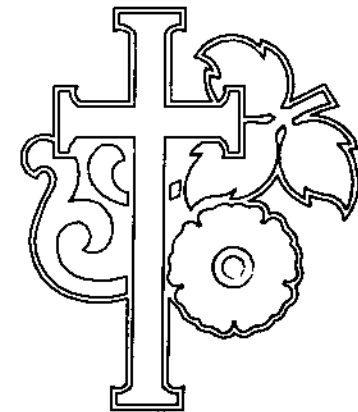

SANDZIMIER MEMORIALS
SCOTSDALE PA STD5R019.CMP



SANDZIMIER MEMORIALS
SCOTTDALE PA

STD5R020 .CMP

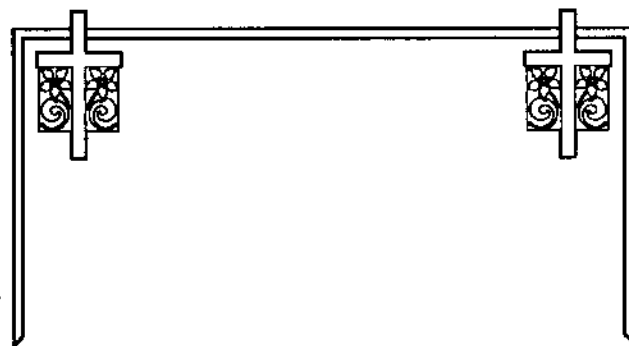

SANDZIMIER MEMORIALS
SCOTTDALE PA

STD5R021 .CMP



SANDZIMIER MEMORIALS
SCOTTDALE PA

STD5R022 .CMP

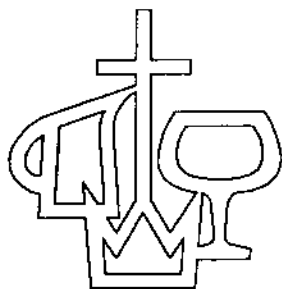

EVERGREEN MEMORIALS
CALGARY ALBERTA

STD5R023 .CMP

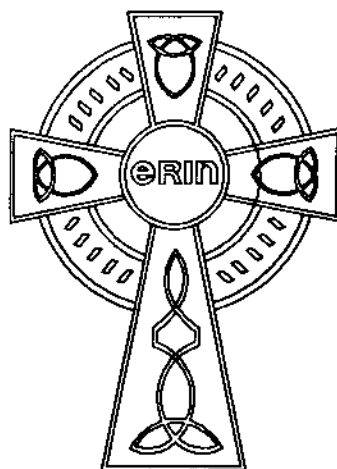

EVERGREEN MEMORIALS
CALGARY ALBERTA

STD5R024 .CMP



SAXON GRANITE
ELBERTON GA

STD5R025 .CMP



SAXON GRANITE
ELBERTON GA

STD5R026 .CMP



STANDARD GRANITE
ELBERTON GA

STD5R027 .CMP

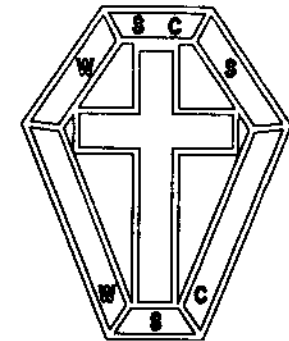

CENTRAL GRANITE CO.
ELBERTON GA

STD5R028 .CMP

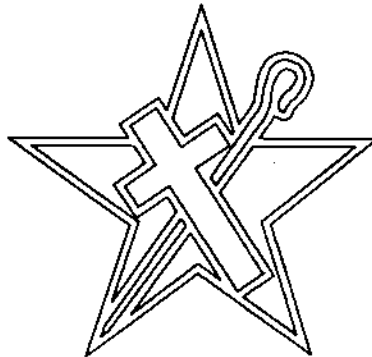

CENTRAL GRANITE CO.
ELBERTON GA

STD5R029 .CMP

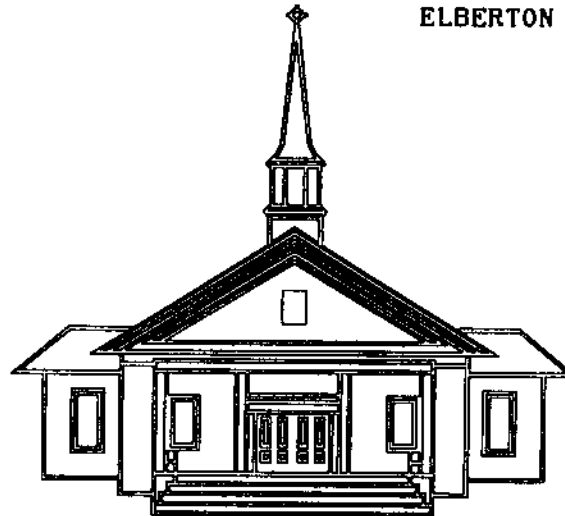

N.C. MARBLE & GRANITE
CLINTON NC

STD5R030 .CMP

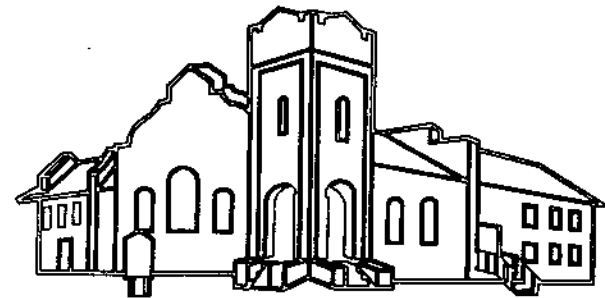

N.C. MARBLE & GRANITE
CLINTON NC

STD5R031 .CMP



7.25 x 16
ARCHIE MON. & STONE
WATERTOWN WI

STD5R032 .CMP

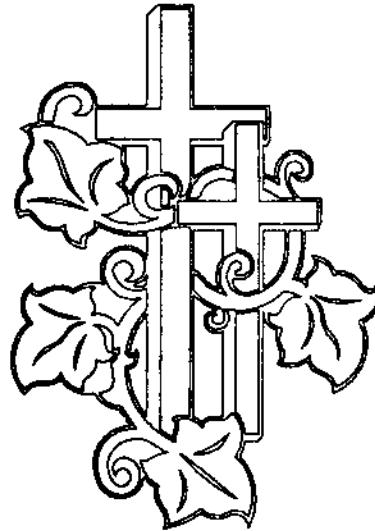

7 x 10
ARCHIE MON. & STONE
WATERTOWN WI

STD5R033 .CMP



4.5 x 9
ARCHIE MON. & STONE
WATERTOWN WI

STD5R034 .CMP

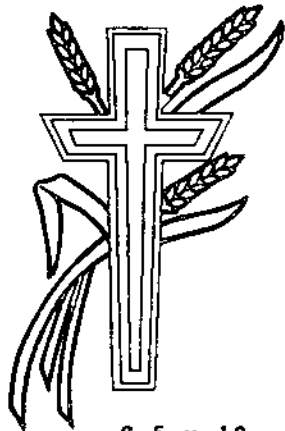

6.5 x 10
ARCHIE MON. & STONE
WATERTOWN WI

STD5R035 .CMP



GRANITE LACROIX
VIMONT-LAVAL QUEBEC

STD5R036 .CMP

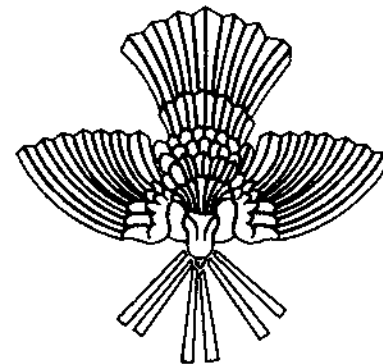

GRANITE LACROIX
VIMONT-LAVAL QUEBEC

STD5R037 .CMP

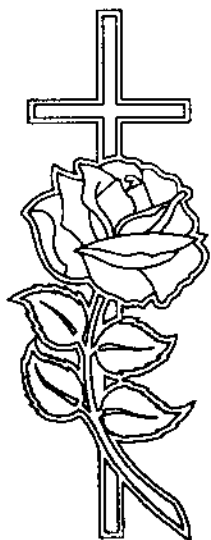

GRANITE LACROIX
VIMONT-LAVAL QUEBEC

STD5R039 .CMP

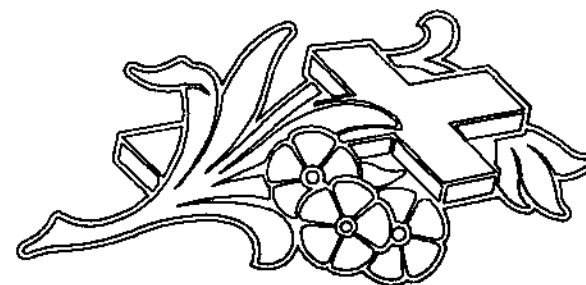
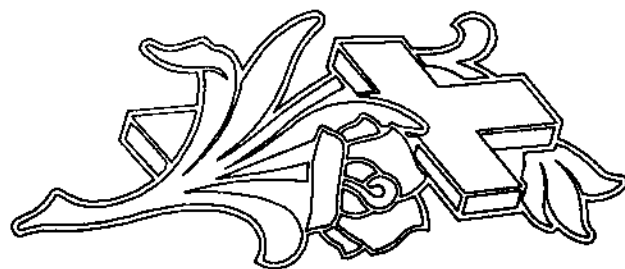

GRANITE LACROIX
VIMONT-LAVAL QUEBEC

STD5R040 .CMP

GRANITE LACROIX
VIMONT-LAVAL QUEBEC

STD5R038 .CMP

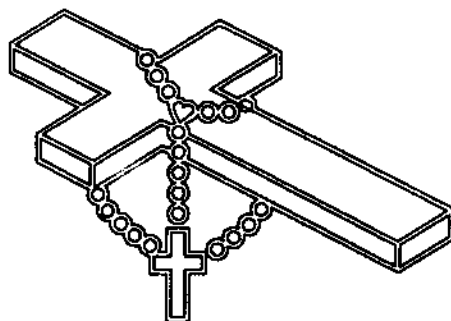
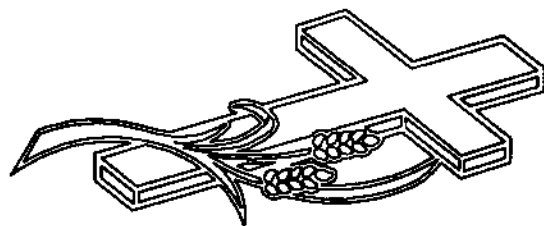

GRANITE LACROIX
VIMONT-LAVAL QUEBEC

STD5R042 .CMP



GRANITE LACROIX
VIMONT-LAVAL QUEBEC

STD5R043 .CMP

GRANITE LACROIX
VIMONT-LAVAL QUEBEC

STD5R041 .CMP



GRANITE LACROIX
VIMONT-LAVAL QUEBEC
STD5R044 .CMP



GRANITE LACROIX
VIMONT-LAVAL QUEBEC
STD5R045 .CMP



GRANITE LACROIX
VIMONT-LAVAL QUEBEC
STD5R046 .CMP



GRANITE LACROIX
VIMONT-LAVAL QUEBEC
STD5R047 .CMP



BREWER MONUMENT CO.
PERRYVILLE MO.
STD5R048 .CMP

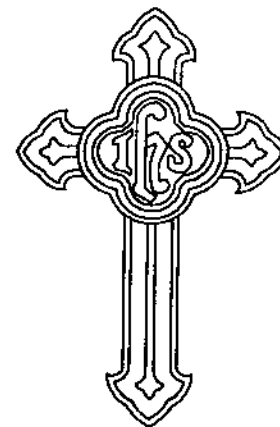

BREWER MONUMENT CO.
PERRYVILLE MO.
STD5R049 .CMP

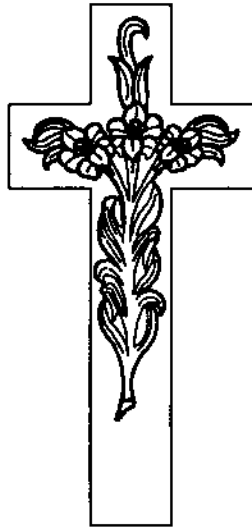

GALLAGHER MONUMENTS
MALAGA OH STD5R050 .CMP



GALLAGHER MONUMENTS
MALAGA OH STD5R051 .CMP



AMITE MARBLE & GRANITE
AMITE LA STD5R052 .CMP



AMITE MARBLE & GRANITE
AMITE LA STD5R053 .CMP



EDWIN F. NICKOL
VERSAILLES OH STD5R054 .CMP

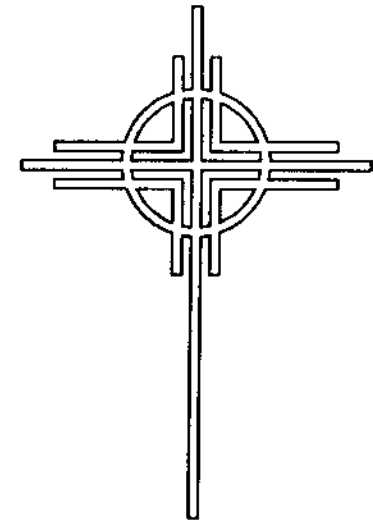

ERIE CITY MEMORIALS
ERIE PA STD5R055 .CMP

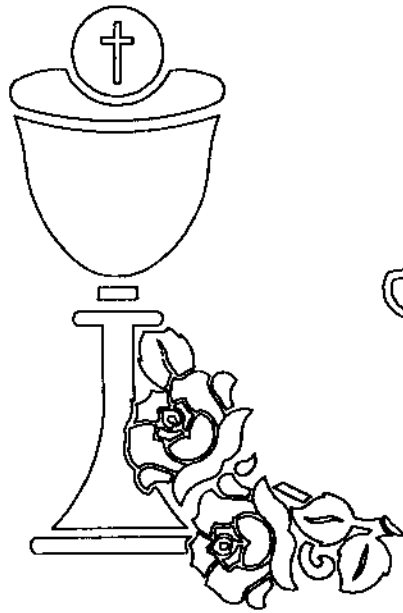

ERIE CITY MEMORIALS
ERIE PA

STD5R056 .CMP



MASTERCARVED MEMORIALS
CLAY CENTER KS

STD5R057 .CMP

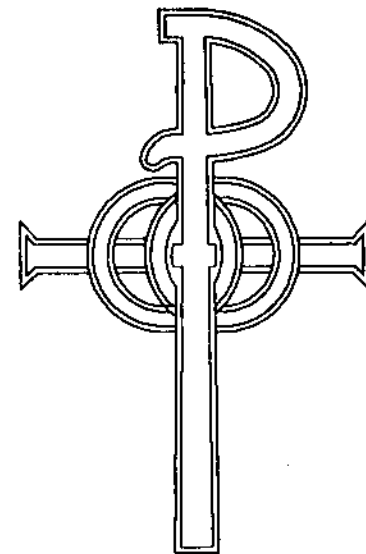

MASTERCARVED MEMORIALS
CLAY CENTER KS

STD5R058 .CMP

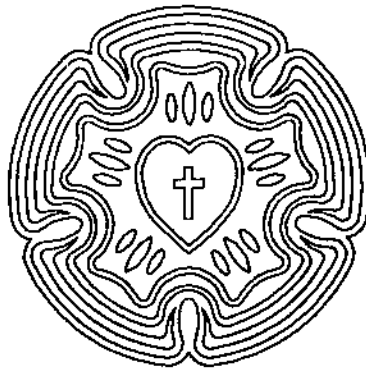

MASTERCARVED MEMORIALS
CLAY CENTER KS

STD5R059 .CMP

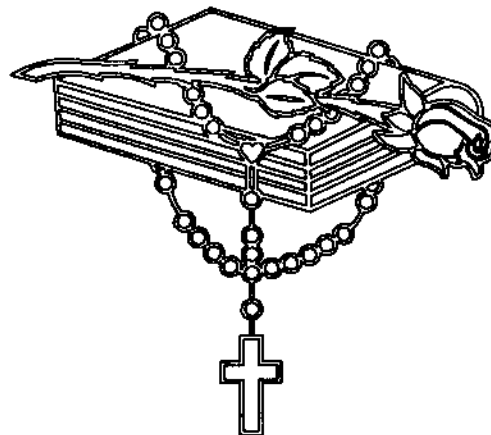

MASTERCARVED MEMORIALS
CLAY CENTER KS

STD5R060 .CMP

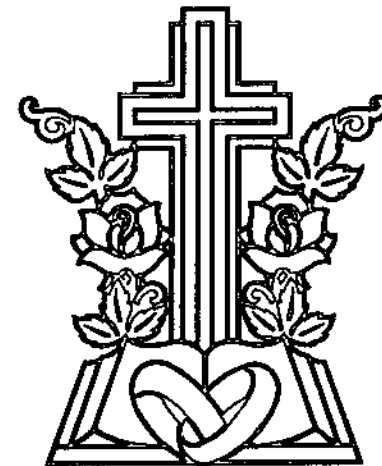

WOODWARD MONUMENT

VICI OK STD5R061 .CMP

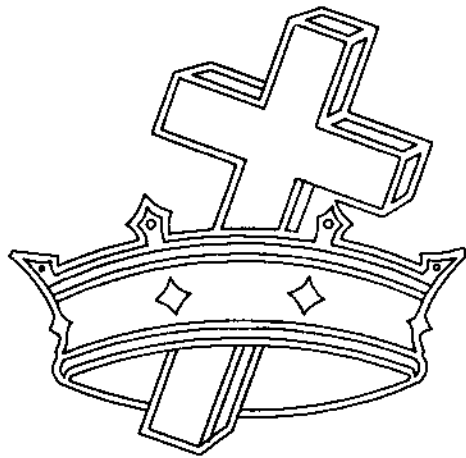

RUST-UNGER MONUMENTS
COLUMBUS IN
STD5R062.CMP

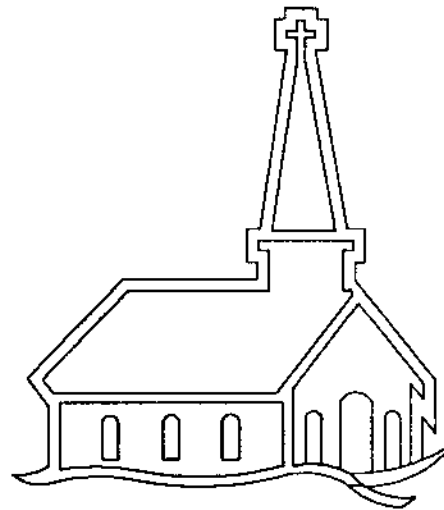

RUST-UNGER MONUMENTS
COLUMBUS IN
STD5R063.CMP

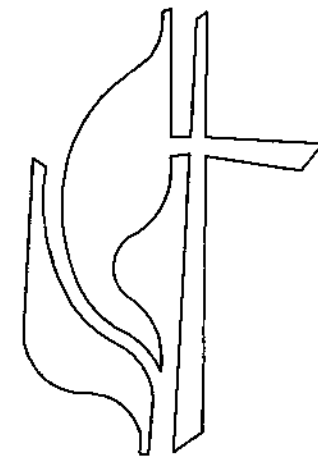

RUST-UNGER MONUMENTS
COLUMBUS IN
STD5R064.CMP



RUST-UNGER MONUMENTS
COLUMBUS IN
STD5R065.CMP

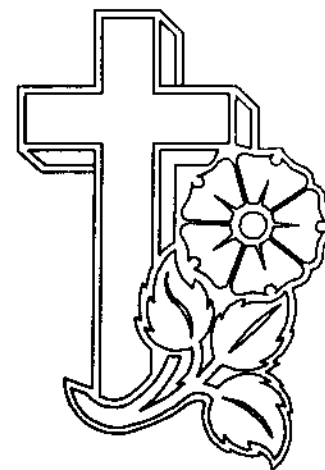

RUST-UNGER MONUMENTS
COLUMBUS IN
STD5R066.CMP

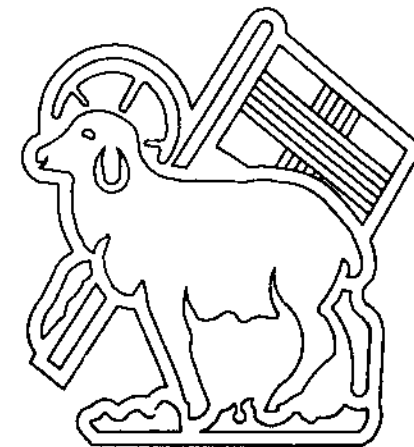

RUST-UNGER MONUMENTS
COLUMBUS IN
STD5R067.CMP





STATEWIDE MEMORIALS
BRUNSWICK ME
STD5R068 .CMP

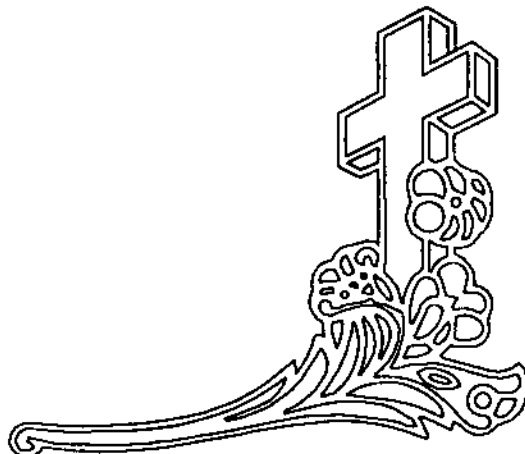

SEAMON-POE MONUMENT CO.
SAN DIEGO CA STD5R069 .CMP

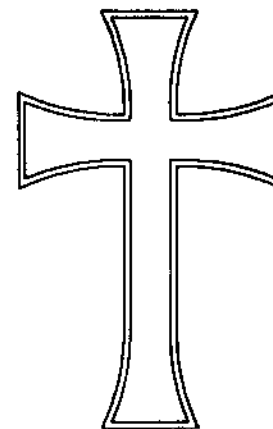

SEAMON-POE MONUMENT CO.
SAN DIEGO CA
STD5R070 .CMP



SEAMON-POE MONUMENT CO.
SAN DIEGO CA STD5R071 .CMP



SEAMON-POE MONUMENT CO.
SAN DIEGO CA STD5R072 .CMP

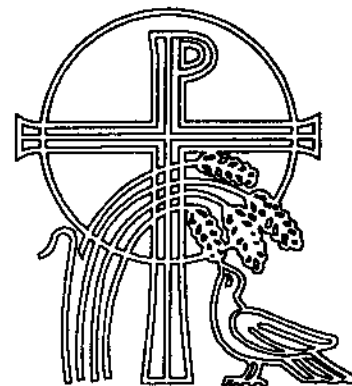

SEAMON-POE MONUMENT CO.
SAN DIEGO CA
STD5R073 .CMP

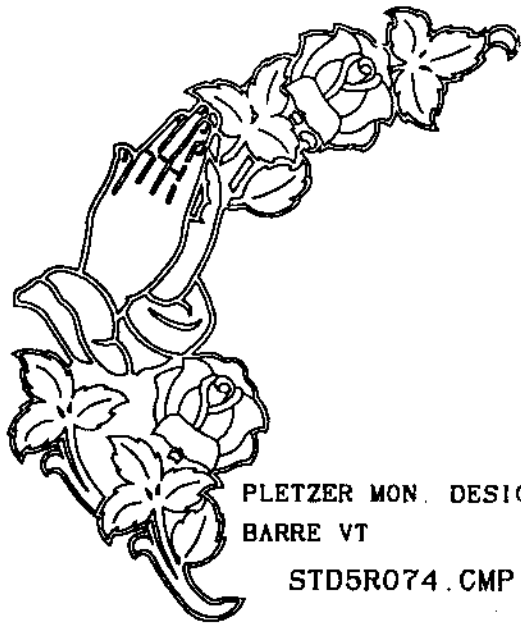

PLETZER MON. DESIGN
BARRE VT
STD5R074.CMP

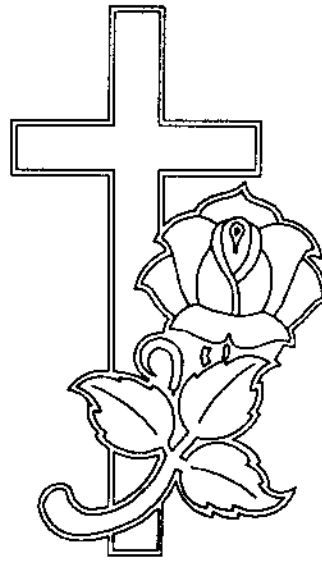

PLETZER MON. DESIGN
BARRE VT
STD5R075.CMP

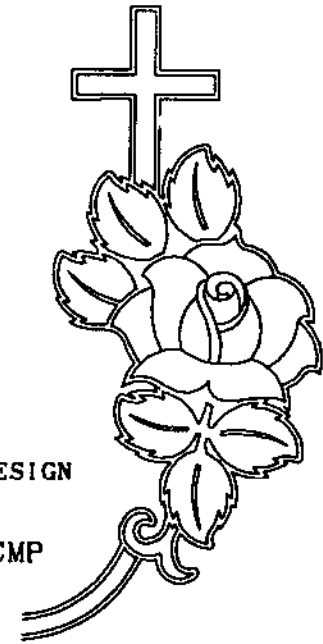

PLETZER MON. DESIGN
BARRE VT
STD5R076.CMP

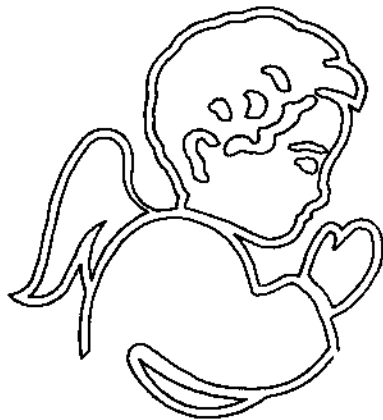

PLETZER MON. DESIGN
BARRE VT
STD5R077.CMP



PLETZER MON. DESIGN
BARRE VT
STD5R078.CMP

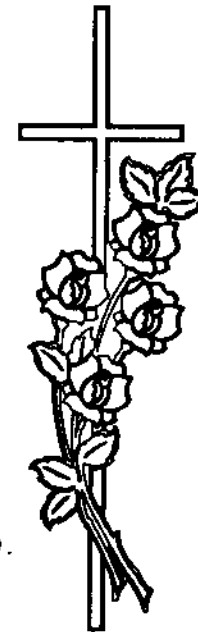

KEITH MONUMENT CO.
ELIZABETHTOWN KY
STD5R079.CMP

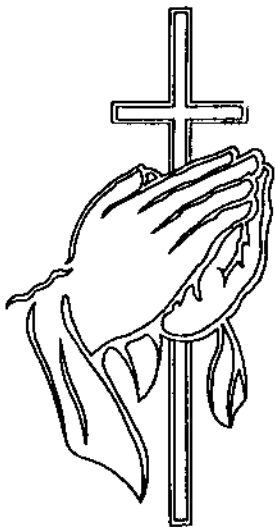

KEITH MONUMENT CO.
ELIZABETHTOWN KY
STD5R080 .CMP

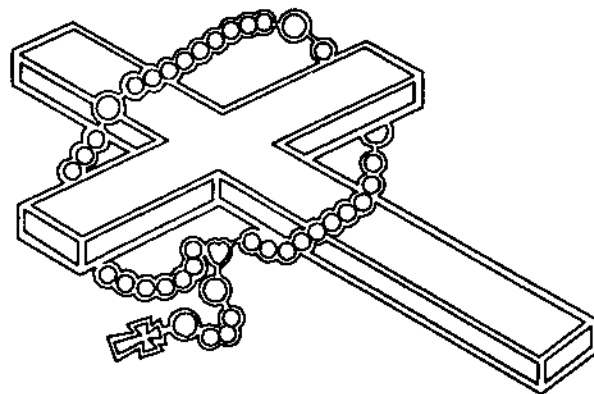

KEITH MONUMENT CO.
ELIZABETHTOWN KY
STD5R081 .CMP



KEITH MONUMENT CO..
ELIZABETHTOWN KY
STD5R082 .CMP



KEITH MONUMENT CO.
ELIZABETHTOWN KY
STD5R083 .CMP



KEITH MONUMENT CO.
ELIZABETHTOWN KY
STD5R084 .CMP



KEITH MONUMENT CO.
ELIZABETHTOWN KY
STD5R085 .CMP

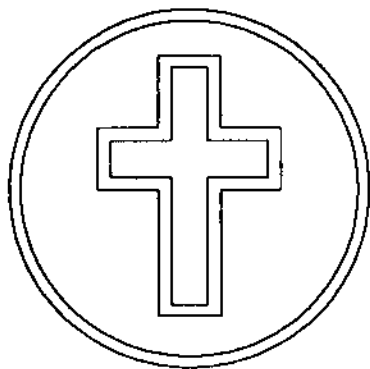

ELBERTON OFFICE SUPPLY

ELBERTON GA

STD5R086.CMP

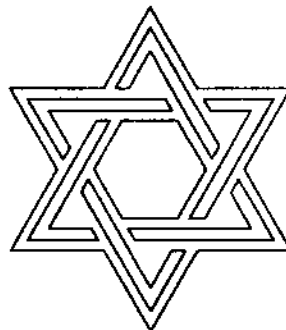

ELBERTON OFFICE SUPPLY

ELBERTON GA

STDR6087.CMP

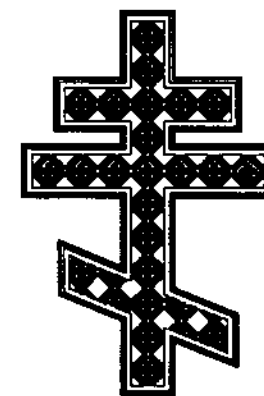

ST. CHARLES MEMORIAL WORKS

ST. CHARLES IL

STD5R088.CMP

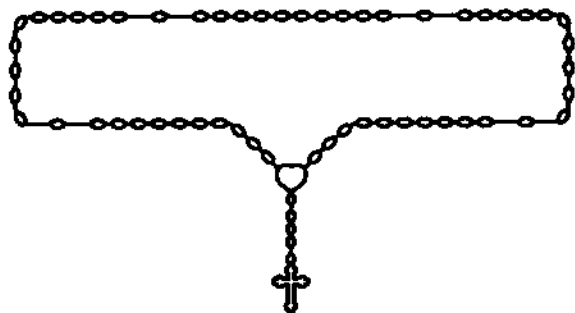

ROLLA MONUMENT CO.

ROLLA MO

STD5R089.CMP



ROLLA MONUMENT CO.

ROLLA MO

STD5R090.CMP



ADVANCED MEMORIAL DESIGN

MORRISTOWN TN

STD5R091.CMP

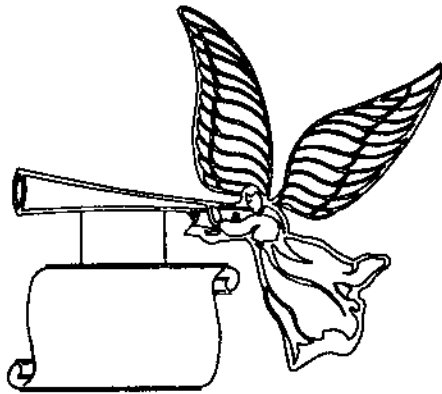

ADVANCED MEMORIAL DESIGN
MORRISTOWN TN

STD5R092.CMP



CREATIVE MEMORIALS
MILTON ONTARIO CANADA

STD5R093.CMP



CREATIVE MEMORIALS
MILTON ONTARIO CANADA

STD5R094.CMP



CREATIVE MEMORIALS
MILTON ONTARIO CANADA

STD5R095.CMP



CREATIVE MEMORIALS
MILTON ONTARIO CANADA

STD5R096.CMP



CREATIVE MEMORIALS
MILTON ONTARIO CANADA

STD5R097.CMP



CREATIVE MEMORIALS
MILTON ONTARIO CANADA

STD5R098 .CMP



CREATIVE MEMORIALS
MILTON ONTARIO CANADA

STD5R099 .CMP



MILACEK MONUMENT CO
OMAHA NE

STD5R100 .CMP

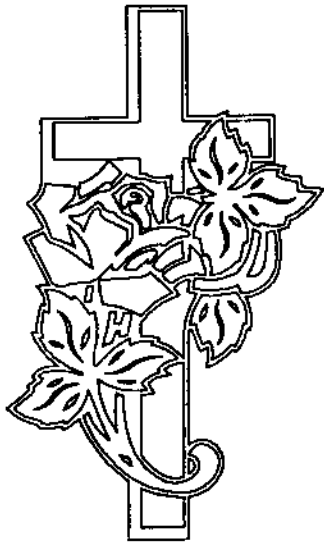

MILACEK MONUMENT CO
OMAHA NE

STD5R101 .CMP

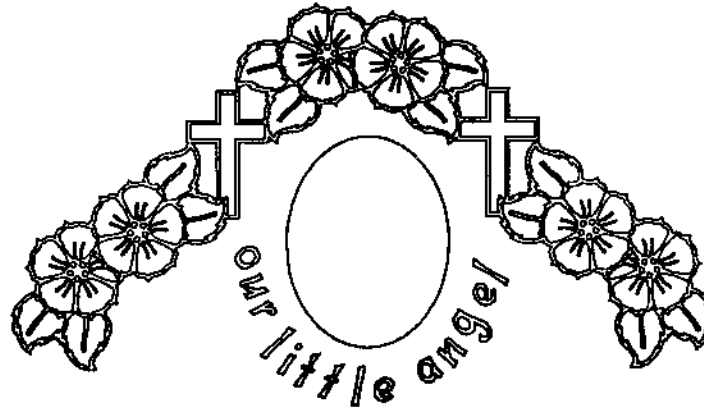

MILACEK MONUMENT CO
OMAHA NE

STD5R102 .CMP



MILACEK MONUMENT CO
OMAHA NE

STD5R103 .CMP



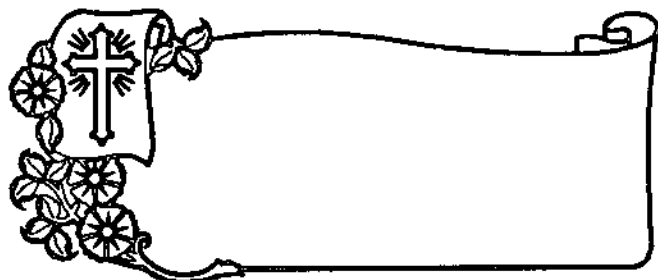

MILLIGAN MEMORIALS
COSHOCOTON OH

STD5R104.CMP



SHEVCHENKO MONUMENTAL WORKS
PERTH AMBOY NJ

STD5R105.CMP

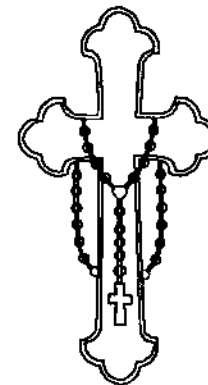

SHEVCHENKO MONUMENTAL WORKS
PERTH AMBOY NJ

STD5R106.CMP

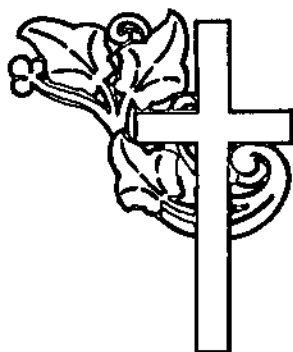

SHEVCHENKO MONUMENTAL WORKS
PERTH AMBOY NJ

STD5R107.CMP



SHEVCHENKO MONUMENTAL WORKS
PERTH AMBOY NJ

STD5R108.CMP

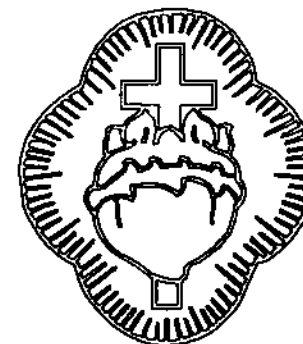

SHEVCHENKO MONUMENTAL WORKS
PERTH AMBOY NJ

STD5R109.CMP

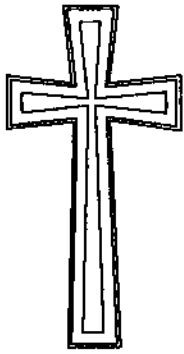

SHEVCHENKO MONUMENTAL WORKS
PERTH AMBOY NJ

STD5R110.CMP

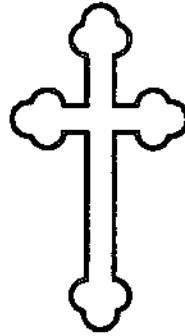

SHEVCHENKO MONUMENTAL WORKS
PERTH AMBOY NJ

STD5R111.CMP

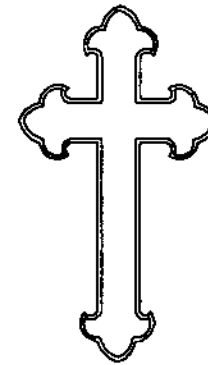

SHEVCHENKO MONUMENTAL WORKS
PERTH AMBOY NJ

STD5R112.CMP

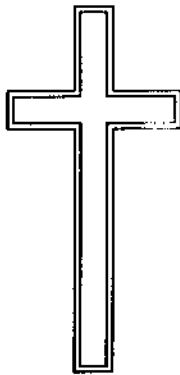

SHEVCHENKO MONUMENTAL WORKS
PERTH AMBOY NJ

STD5R113.CMP

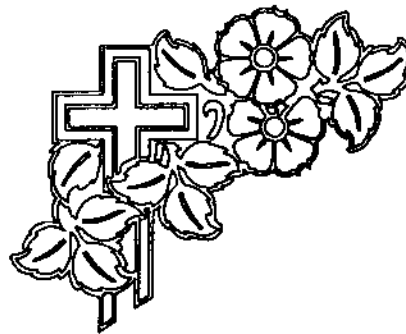

QUALITY-CUT MONUMENTAL DESIGNS
ELBERTON GA

STD5R114.CMP

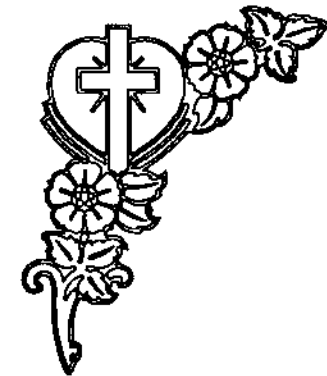

QUALITY-CUT MONUMENTAL DESIGNS
ELBERTON GA

STD5R115.CMP

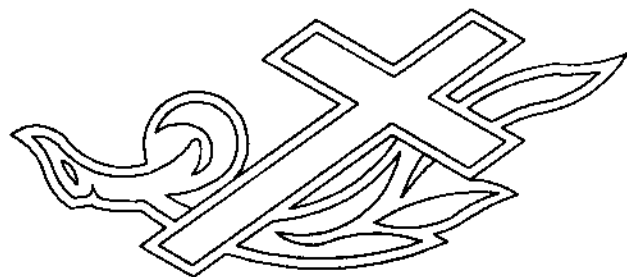

SEBASTIANO AIELLO MONUMENTS INC
MONTREAL QUEBEC CANADA

STD5R116.CMP

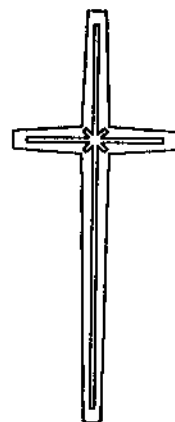

SEBASTIANO AIELLO MONUMENTS INC
MONTREAL QUEBEC CANADA

STD5R117.CMP

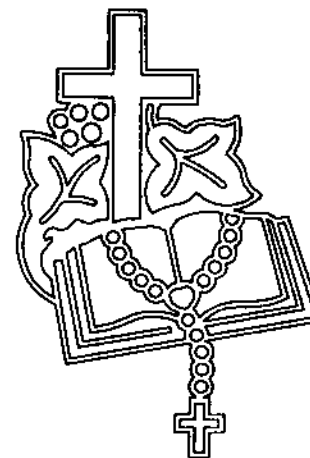

BOYCE MONUMENTAL SALES LTD
CARROLL IA

STD5R118.CMP

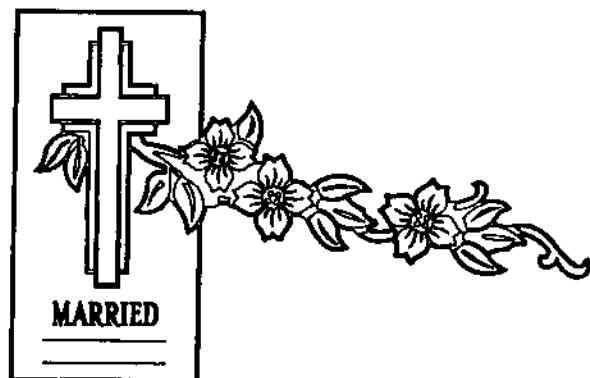

BOYCE MONUMENTAL SALES LTD
CARROLL IA

STD5R119.CMP



BOYCE MONUMENTAL SALES LTD
CARROLL IA

STD5R120.CMP



BOYCE MONUMENTAL SALES LTD
CARROLL IA

STD5R121.CMP

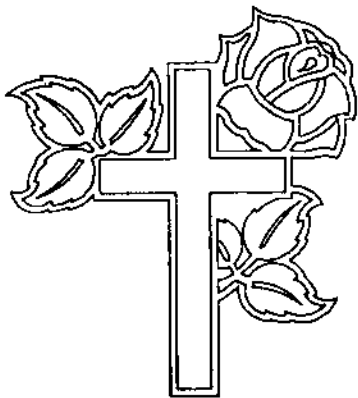

BAY MONUMENT CO
BAY CITY MI

STD5R122.CMP

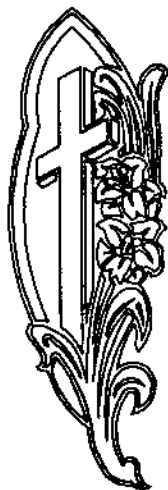

BAY MONUMENT CO
BAY CITY MI

STD5R123.CM

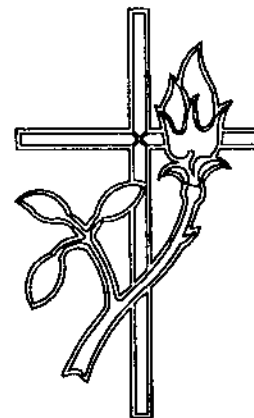

BAY MONUMENT CO
BAY CITY MI

STD5R124.CMP



BAY MONUMENT CO
BAY CITY MI

STD5R125.CMP

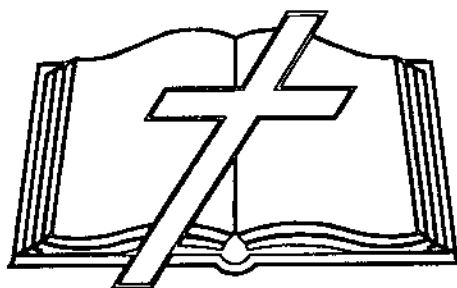

BAY MONUMENT CO
BAY CITY MI

STD5R126.CMP

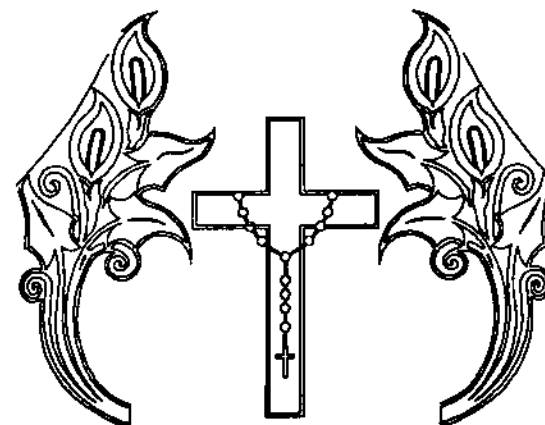

RMG STONE PRODUCTS
CASTLETON VT

STD5R127.CMP

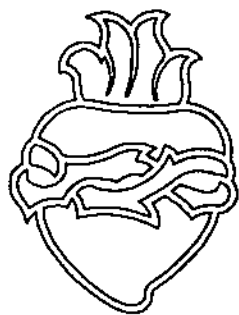

RMG STONE PRODUCTS
CASTLETON VT

STD5R128.CMP

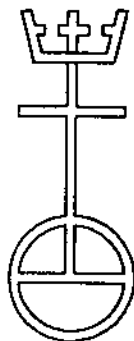

RMG STONE PRODUCTS
CASTLETON VT

STD5R129.CMP

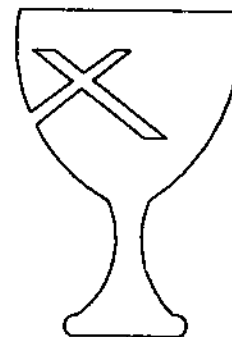

RMG STONE PRODUCTS
CASTLETON VT

STD5R130.CMP



RMG STONE PRODUCTS
CASTLETON VT

STD5R131.CMP

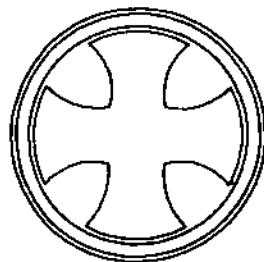

RMG STONE PRODUCTS
CASTLETON VT

STD5R132.CMP

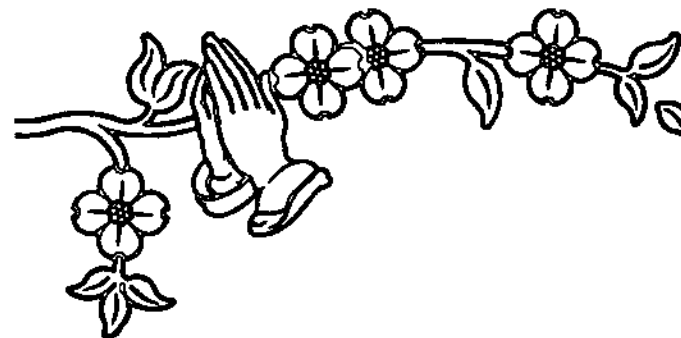

LONGSTRETH MEMORIALS
GALION OH

STD5R133.CMP

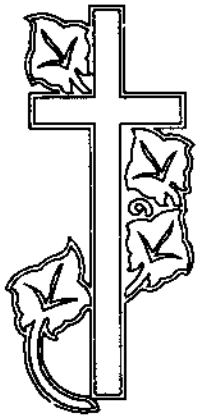

LONGSTRETH MEMORIALS
GALION OH

STD6R134.CMP



LONGSTRETH MEMORIALS
GALION OH

STD5R135.CMP

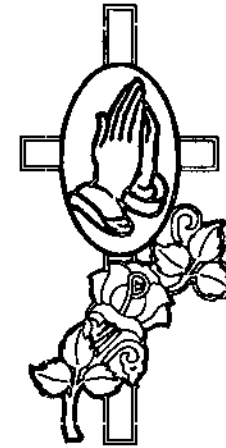

LONGSTRETH MEMORIALS
GALION OH

STD5R136.CMP

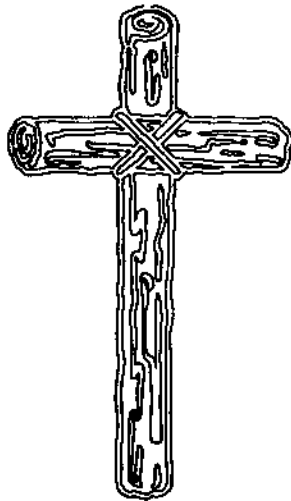

CROWN MONUMENT
WARREN OH

STD5R137.CMP

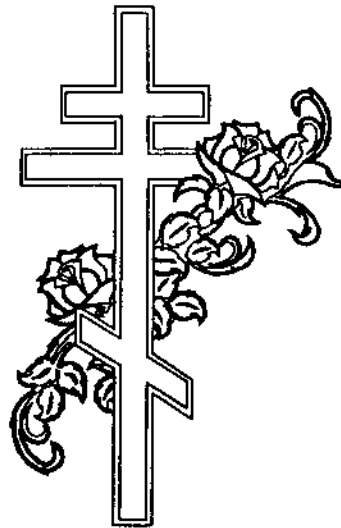

CROWN MONUMENT
WARREN OH

STD5R138.CMP

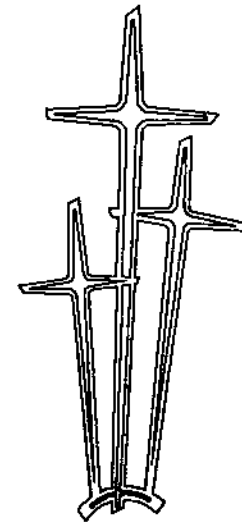

CROWN MONUMENT
WARREN OH

STD5R139.CMP



CROWN MONUMENT
WARREN OH

STD5R140.CMP

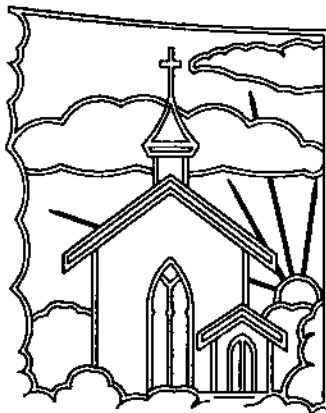

W.P. SIMMONS. INC.
MT. AIRY NC

STD5R141.CMP



CAPITOL HILL MONUMENT
OKLAHOMA CITY OK

STD5R142.CMP



ALAN E. FRICKE MEMORIALS INC
MEDFORD NY

STD5R143.CMP



ALAN E. FRICKE MEMORIALS INC
MEDFORD NY

STD5R144.CMP



ALAN E. FRICKE MEMORIALS INC
MEDFORD NY

STD5R145.CMP



ALAN E. FRICKE MEMORIALS INC
MEDFORD NY

STD5R146.CMP



ALAN E. FRICKE MEMORIALS INC
MEDFORD NY

STD6R147.CMP



ALAN E. FRICKE MEMORIALS INC
MEDFORD NY

STD6R148.CMP

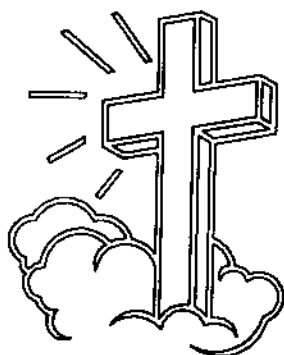

ALAN E. FRICKE MEMORIALS INC
MEDFORD NY

STD5R149.CMP

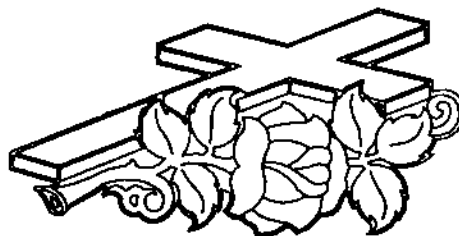

ALAN E. FRICKE MEMORIALS INC
MEDFORD NY

STD6R150.CMP

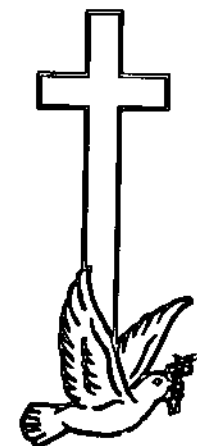

ALAN E. FRICKE MEMORIALS INC
MEDFORD NY

STD5R151.CMP

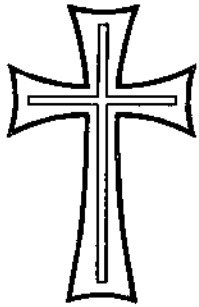

ALAN E. FRICKE MEMORIALS INC
MEDFORD NY

STD5R152.CMP



ALAN E. FRICKE MEMORIALS INC
MEDFORD NY

STD5R153.CMP

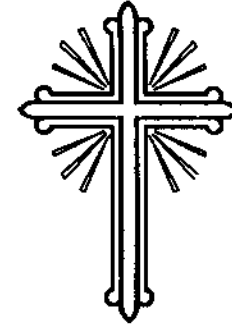

ALAN E. FRICKE MEMORIALS INC
MEDFORD NY

STD5R154.CMP

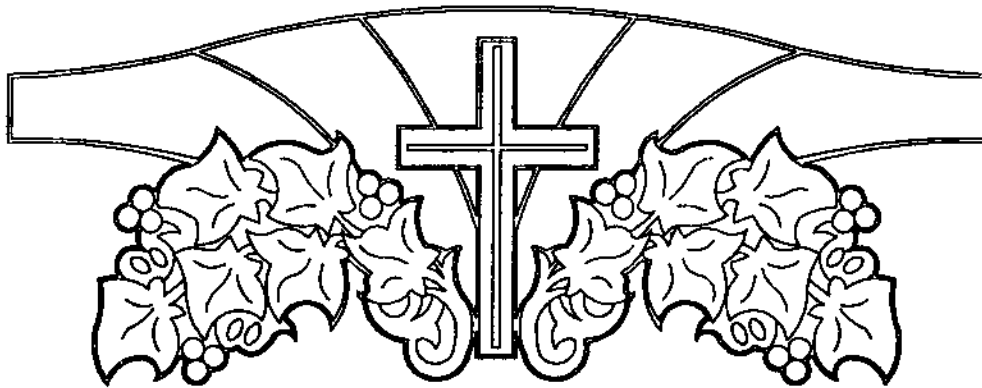

ALAN E. FRICKE MEMORIALS INC
MEDFORD NY

STD5R155.CMP

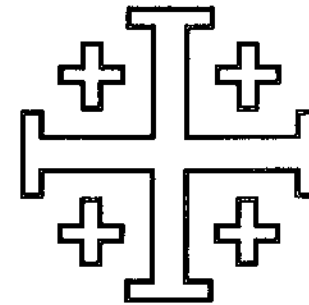

ALAN E. FRICKE MEMORIALS INC
MEDFORD NY

STD5R156.CMP



SMYTH MEMORIAL CO
CHATHAM ONTARIO CANADA

STD5R157.CMP



MILANO MONUMENTS
CLEVELAND OH

STD5R158.CMP



MILANO MONUMENTS
CLEVELAND OH

STD5R159.CMP



MILANO MONUMENTS
CLEVELAND OH

STD5R160.CMP



MILANO MONUMENTS
CLEVELAND OH

STD5R161.CMP



MILANO MONUMENTS
CLEVELAND OH

STD5R162.CMP

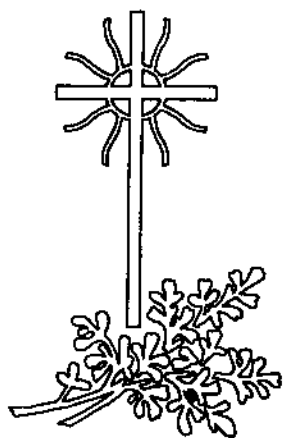

MILANO MONUMENTS
CLEVELAND OH

STD5R163.CMP

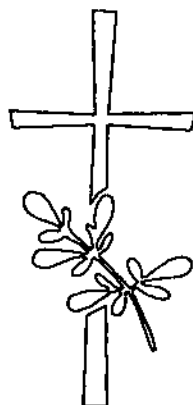

MILANO MONUMENTS
CLEVELAND OH

STD5R164.CMP

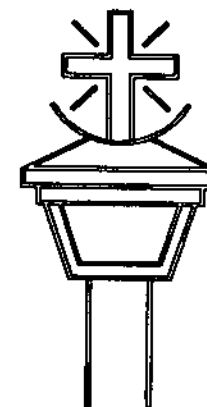

MILANO MONUMENTS
CLEVELAND OH

STD5R165.CMP

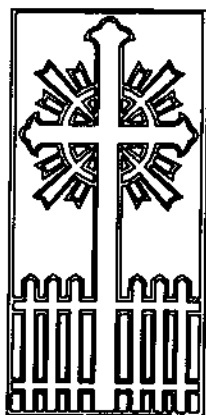

MILANO MONUMENTS
CLEVELAND OH

STD5R166.CMP



MILANO MONUMENTS
CLEVELAND OH

STD5R167.CMP



MILANO MONUMENTS
CLEVELAND OH

STD5R168.CMP

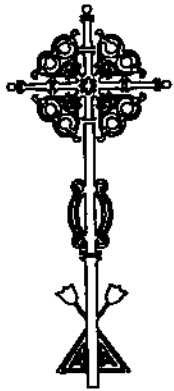

MILANO MONUMENTS
CLEVELAND OH

STD5R169.CMP

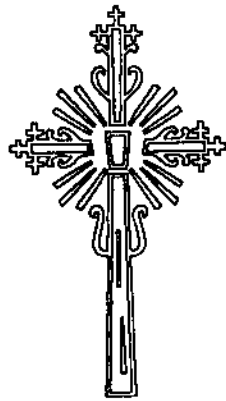

MILANO MONUMENTS
CLEVELAND OH

STD5R170.CMP

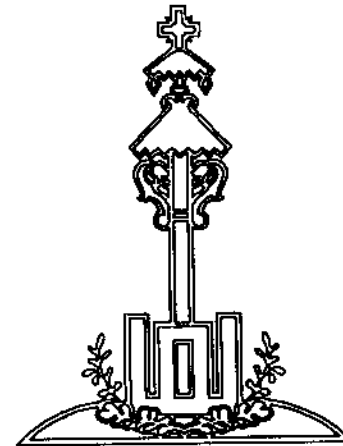

MILANO MONUMENTS
CLEVELAND OH

STD5R171.CMP



MILANO MONUMENTS
CLEVELAND OH

STD5R172.CMP

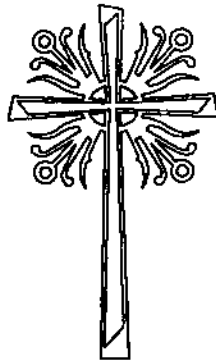

MILANO MONUMENTS
CLEVELAND OH

STD5R173.CMP



MILANO MONUMENTS
CLEVELAND OH

STD5R174.CMP



MILANO MONUMENTS
CLEVELAND OH

STD5R176.CMP



MILANO MONUMENTS
CLEVELAND OH

STD5R176.CMP



MILANO MONUMENTS
CLEVELAND OH

STD5R177.CMP



MILWAUKEE MEMORIAL CO
MILWAUKEE WI

STD5R178.CMP

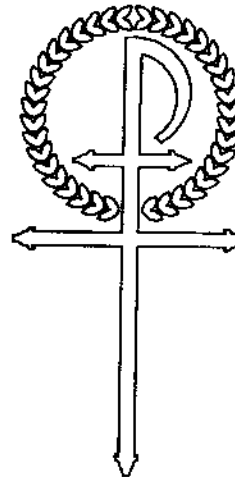

MILWAUKEE MEMORIAL CO
MILWAUKEE WI

STD5R179.CMP



MILWAUKEE MEMORIAL CO
MILWAUKEE WI

STD5R180.CMP



MILWAUKEE MEMORIAL CO
MILWAUKEE WI

STD5R181.CMP

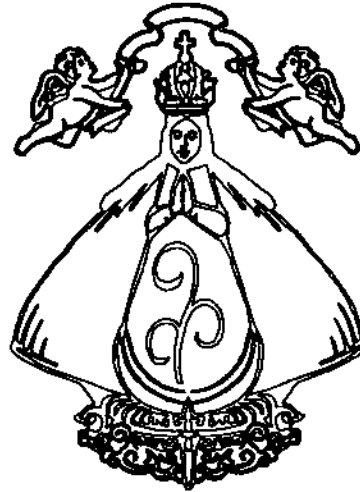

MILWAUKEE MEMORIAL CO
MILWAUKEE WI

STD5R182.CMP



HUTCH CUSTOM DESIGN
GROVETON NH

STD5R183.CMP



HUTCH CUSTOM DESIGN
GROVETON NH

STD5R184.CMP



HUTCH CUSTOM DESIGN
GROVETON NH

STD5R185.CMP



HUTCH CUSTOM DESIGN
GROVETON NH

STD5R186.CMP



HUTCH CUSTOM DESIGN
GROVETON NH

STD5R187.CMP



HUTCH CUSTOM DESIGN
GROVETON NH

STD5R188.CMP



HUTCH CUSTOM DESIGN
GROVETON NH

STD5R189.CMP



MOORE MONUMENT CO
CHILLICOTHE MO

STD5R190.CMP

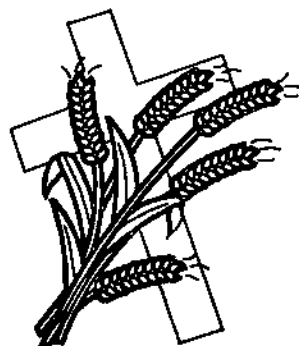

PEORIA MONUMENT CO
PEORIA IL

STD5R191.CMP

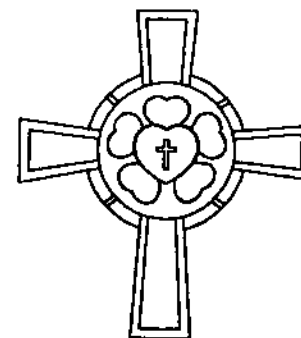

PEORIA MONUMENT CO
PEORIA IL

STD5R192.CMP



PEORIA MONUMENT CO
PEORIA IL

STD5R193.CMP



JAMESTOWN MONUMENT
JAMESTOWN ND

STD5R194.CMP

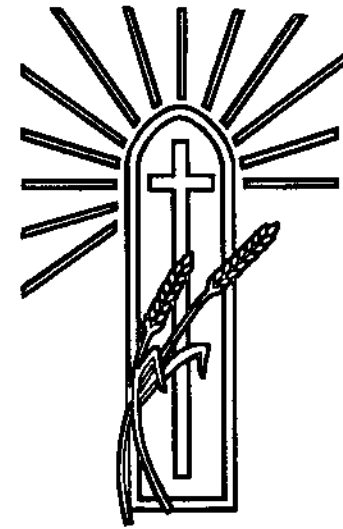

JAMESTOWN MONUMENT
JAMESTOWN ND

STD5R195.CMP



HAMILTON MEMORIALS
HAMILTON ONTARIO CANADA

STD5R196.CMP

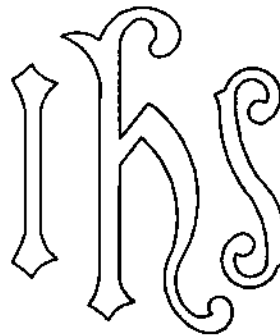

HAMILTON MEMORIALS
HAMILTON ONTARIO CANADA

STD5R197.CMP

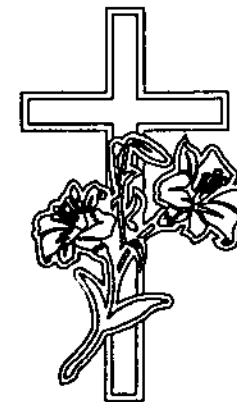

HAMILTON MEMORIALS
HAMILTON ONTARIO CANADA

STD5R198.CMP

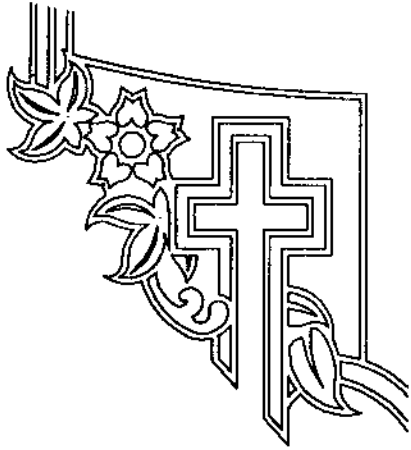

HAMILTON MEMORIALS
HAMILTON ONTARIO CANADA

STD5R199.CMP

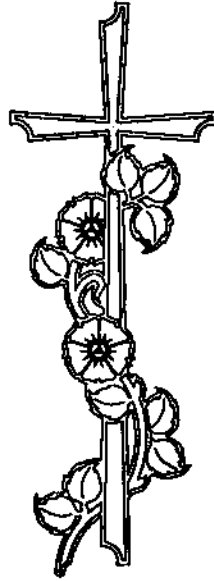

HAMILTON MEMORIALS
HAMILTON ONTARIO CANADA

STD5R200.CMP

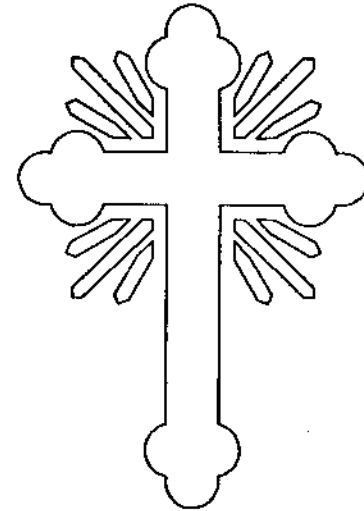

HAMILTON MEMORIALS
HAMILTON ONTARIO CANADA

STD5R201.CMP

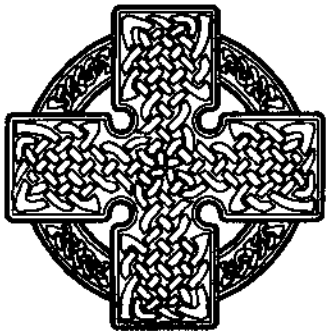

McGARRY MEMORIALS
CHORLTON MANCHESTER UK

STD5R202.CMP



McGARRY MEMORIALS
CHORLTON MANCHESTER UK

STD5R203.CMP

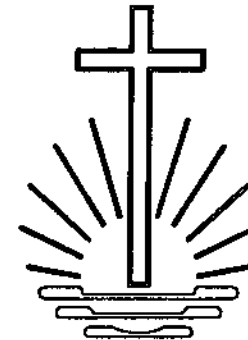

SOUTH BEND MONUMENT WORKS
SOUTH BEND IN

STD5R204.CMP

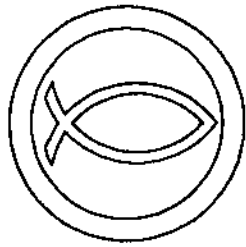

SOUTH BEND MONUMENT WORKS
SOUTH BEND IN

STD5R205 .CMP

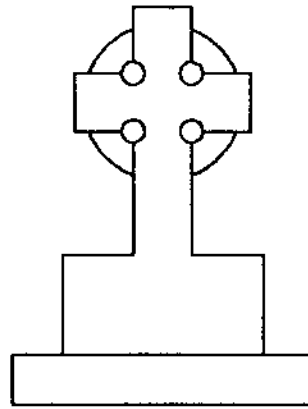

SOUTH BEND MONUMENT WORKS
SOUTH BEND IN

STD5R206 .CMP

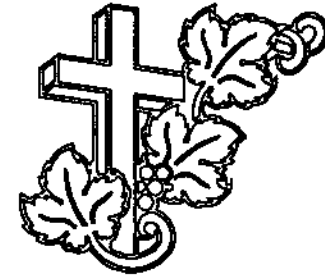

SOUTH BEND MONUMENT WORKS
SOUTH BEND IN

STD5R207 .CMP

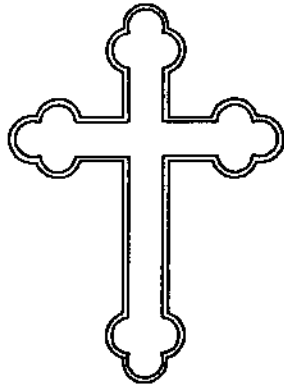

SOUTH BEND MONUMENT WORKS
SOUTH BEND IN

STD5R208 .CMP

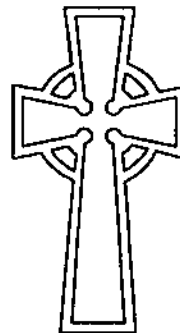

BARRE MEMORIALS
HYDE PARK NY

STD5R209 .CMP

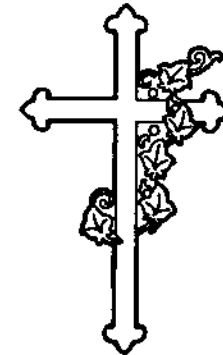

BARRE MEMORIALS
HYDE PARK NY

STD5R210 .CMP





BARRE MEMORIALS
HYDE PARK NY

STD5R211.CMP



KIRKPATRICK & O'BRINE LTD
FONTHILL ONTARIO CANADA

STD5R212.CMP



KIRKPATRICK & O'BRINE LTD
FONTHILL ONTARIO CANADA

STD5R213.CMP



KIRKPATRICK & O'BRINE LTD
FONTHILL ONTARIO CANADA

STD5R214.CMP

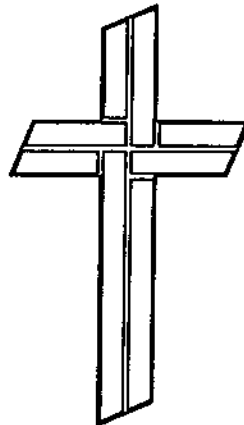

KIRKPATRICK & O'BRINE LTD
FONTHILL ONTARIO CANADA

STD5R215.CMP

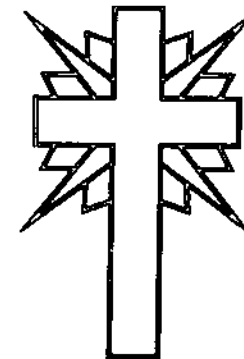

KIRKPATRICK & O'BRINE LTD
FONTHILL ONTARIO CANADA

STD5R216.CMP

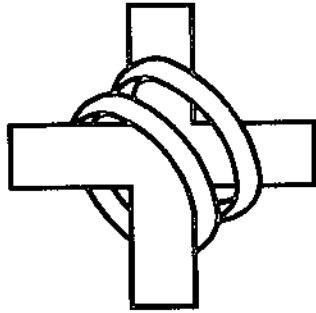

KIRKPATRICK & O'BRINE LTD
FONTHILL ONTARIO CANADA

STD5R217.CMP

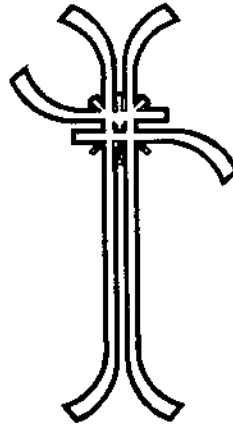

KIRKPATRICK & O'BRINE LTD
FONTHILL ONTARIO CANADA

STD5R218.CMP

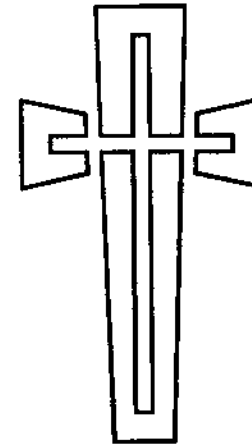

KIRKPATRICK & O'BRINE LTD
FONTHILL ONTARIO CANADA

STD5R219.CMP



KIRKPATRICK & O'BRINE LTD
FONTHILL ONTARIO CANADA

STRD5R220.CMP

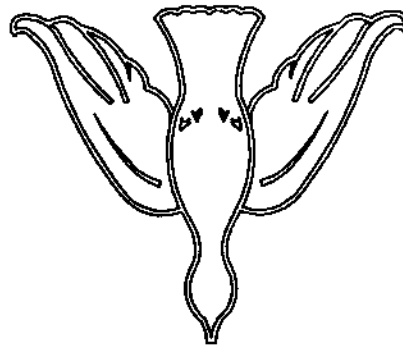

KIRKPATRICK & O'BRINE LTD
FONTHILL ONTARIO CANADA

STD5R221.CMP

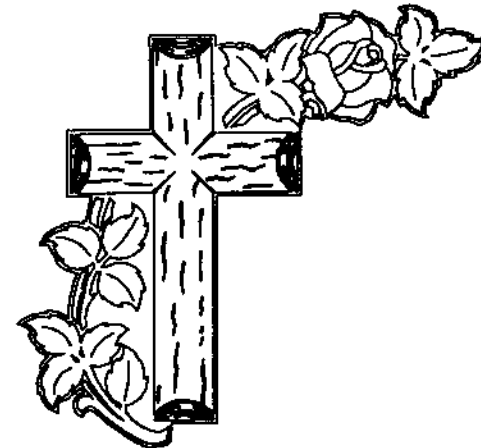

WOODSIDE GRANITE
ALBION NY

STD5R222.CMP



WOODSIDE GRANITE
ALBION NY

STD5R223 .CMP



WOODSIDE GRANITE
ALBION NY

STD5R224 .CMP

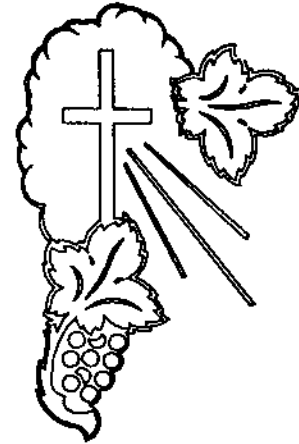

WOODSIDE GRANITE
ALBION NY

STD5R225 .CMP

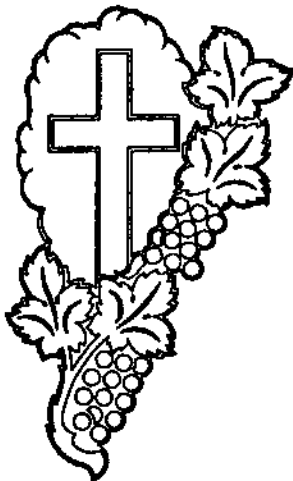

WOODSIDE GRANITE
ALBION NY

STD5R226 .CMP

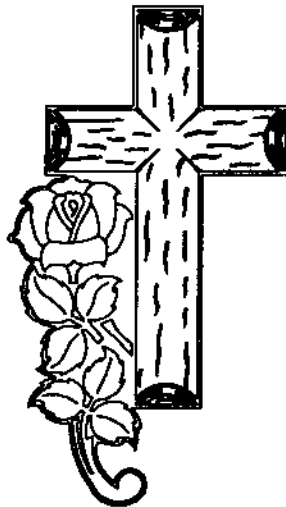

WOODSIDE GRANITE
ALBION NY

STD5R227 .CMP



WOODSIDE GRANITE
ALBION NY

STD5R228 .CMP

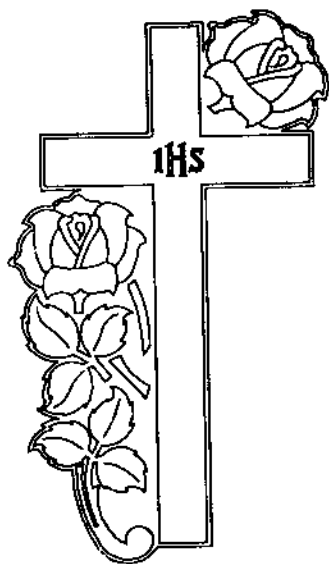

WOODSIDE GRANITE
ALBION NY

STD5R229 .CMP



BROWN MONUMENT
LOGAN UT

STD5R230 .CMP



BROWN MONUMENT
LOGAN UT

STD5R231 .CMP

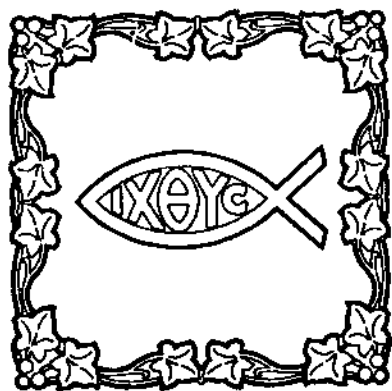

MASTERCRAFT MEMORIALS
RICHMOND IN

STD5R232 .CMP



MASTERCRAFT MEMORIALS
RICHMOND IN

STD5R233 .CMP

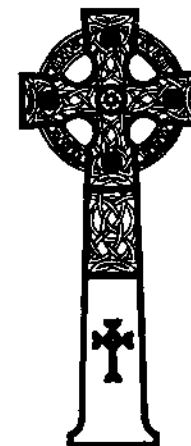

MASTERCRAFT MEMORIALS
RICHMOND IN

STD5R234 .CMP



GRANITE APPALACHES
LAC DROLET QUEBEC CANADA

STD5R235 .CMP

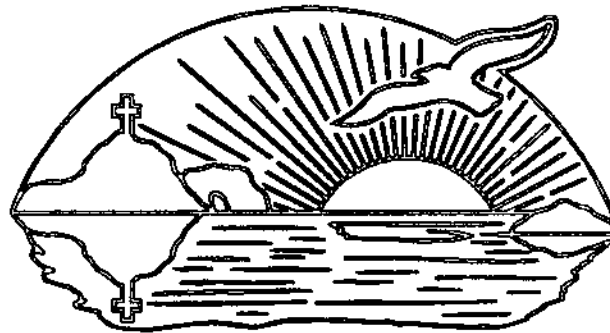

GRANITE APPALACHES
LAC DROLET QUEBEC CANADA

STD5R236 .CMP

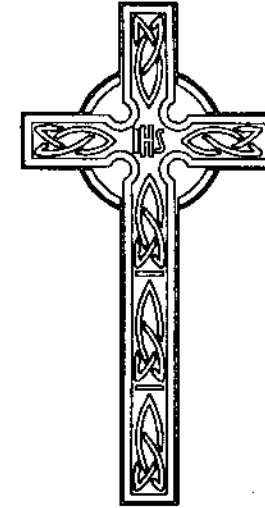

GRANITE APPALACHES
LAC DROLET QUEBEC CANADA

STD5R237 .CMP



GRANITE APPALACHES
LAC DROLET QUEBEC CANADA

STD5R238 .CMP



FOREST PARK MEMORIALS
HOUSTON TX

STD5R239 .CMP



FOREST PARK MEMORIALS
HOUSTON TX

STD5R240 .CMP

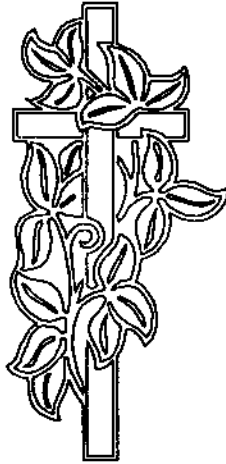

FOREST PARK MEMORIALS
HOUSTON TX

STD5R241 .CMP

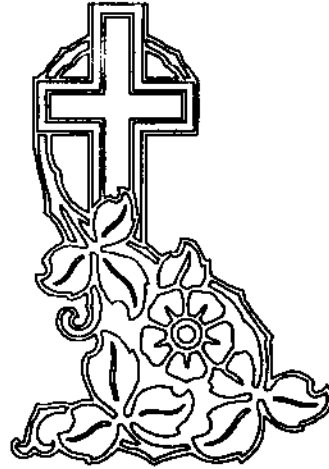

FOREST PARK MEMORIALS
HOUSTON TX

STD5R242 .CMP



FOREST PARK MEMORIALS
HOUSTON TX

STD5R243 .CMP



FOREST PARK MEMORIALS
HOUSTON TX

STD5R244 .CMP

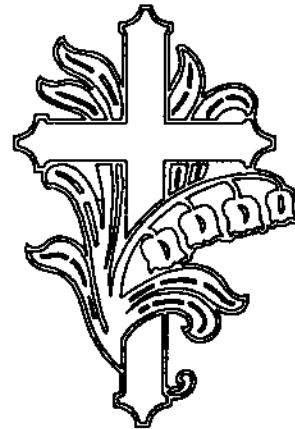

TROY MARBLE & GRANITE WORKS
TROY PA

STD5R245 .CMP

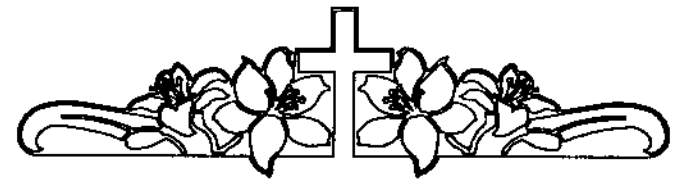

TROY MARBLE & GRANITE WORKS
TROY PA

STD5R246 .CMP



BAILEY MONUMENT CO
WAYCROSS GA

STD5R247.CMP

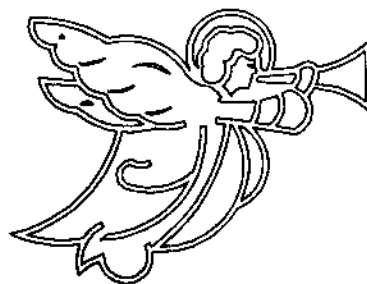

L. J. SERVICES
CHERRY VALLEY NY

STD5R248.CMP



L. J. SERVICES
CHERRY VALLEY NY

STD5R249.CMP



L. J. SERVICES
CHERRY VALLEY NY

STD5R250.CMP



L. J. SERVICES
CHERRY VALLEY NY

STD5R251.CMP



L. J. SERVICES
CHERRY VALLEY NY

STD5R252.CMP



L. J. SERVICES
CHERRY VALLEY NY

STD5R253 .CMP



L. J. SERVICES
CHERRY VALLEY NY

STD5R254 .CMP



L. J. SERVICES
CHERRY VALLEY NY

STD5R255 .CMP



L. J. SERVICES
CHERRY VALLEY NY

STD5R256 .CMP

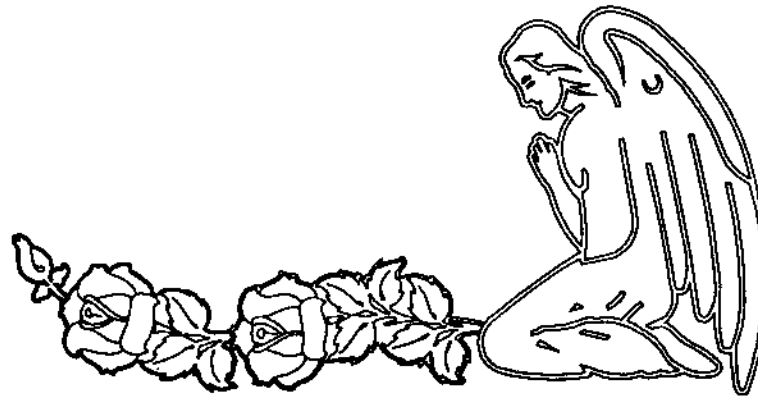

L. J. SERVICES
CHERRY VALLEY NY

STD5R257 .CMP



L. J. SERVICES
CHERRY VALLEY NY

STD5R258 .CMP



L. J. SERVICES
CHERRY VALLEY NY

STD5R259.CMP



L. J. SERVICES
CHERRY VALLEY NY

STD5R260.CMP



L. J. SERVICES
CHERRY VALLEY NY

STD5R261.CMP



L. J. SERVICES
CHERRY VALLEY NY

STD5R262.CMP

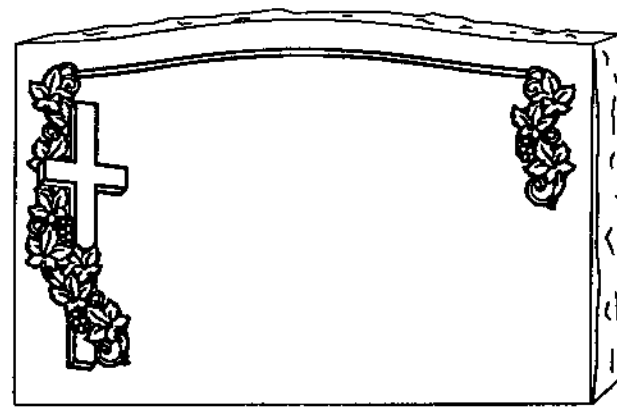

L. J. SERVICES
CHERRY VALLEY NY

STD5R263.CMP



L. J. SERVICES
CHERRY VALLEY NY

STD5R264.CMP

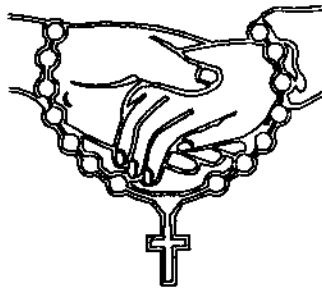

L. J. SERVICES
CHERRY VALLEY NY

STD5R265.CMP

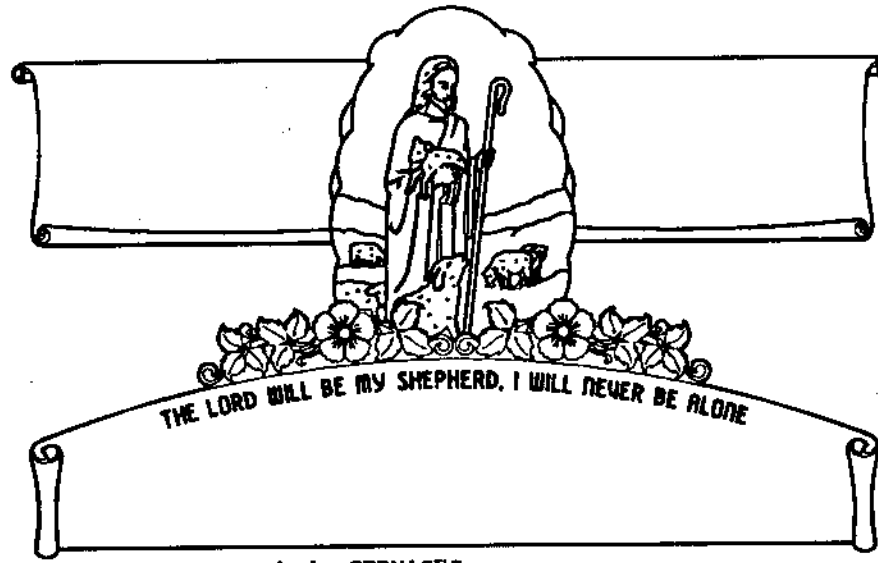

L. J. SERVICES
CHERRY VALLEY NY

STD5R268.CMP

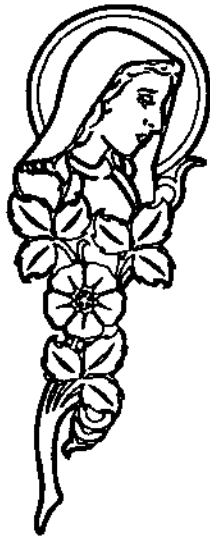

L. J. SERVICES
CHERRY VALLEY NY

STD5R267.CMP



L. J. SERVICES
CHERRY VALLEY NY

STD5R268.CMP

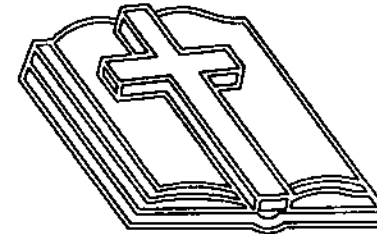

VISALIA GRANITE & MARBLE WORKS
VISALIA CA

STD5R269.CMP

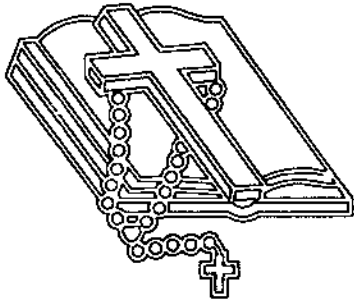

VISALIA GRANITE & MARBLE WORKS
VISALIA CA

STD5R270.CMP

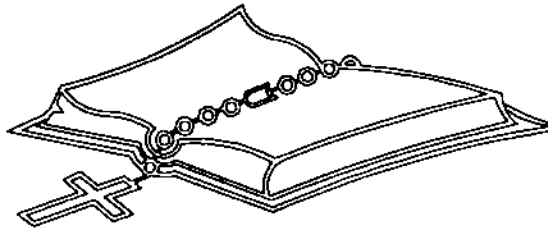

VISALIA GRANITE & MARBLE WORKS
VISALIA CA

STD5R271.CMP



VISALIA GRANITE & MARBLE WORKS
VISALIA CA

STD5R272.CMP

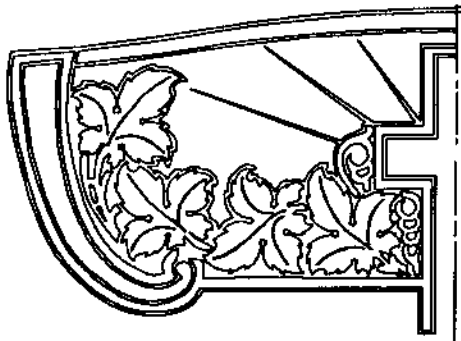

BRACOLONI CUSTOM MEMORIALS
TRENTON NJ

STD5R273.CMP

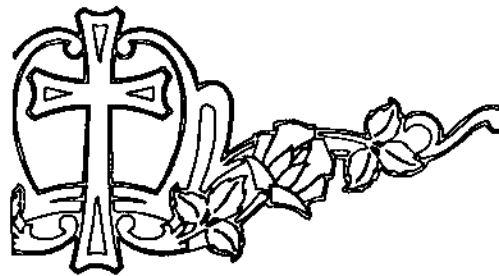

BRACOLONI CUSTOM MEMORIALS
TRENTON NJ

STD5R274.CMP



BRACOLONI CUSTOM MEMORIALS
TRENTON NJ

STD5R275.CMP

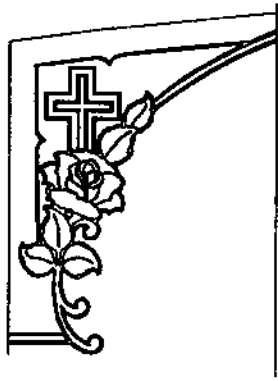

BRACOLONI CUSTOM MEMORIALS
TRENTON NJ

STD5R276.CMP

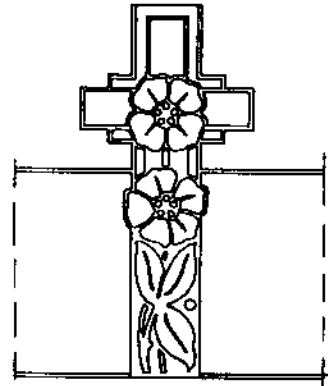

BRACOLONI CUSTOM MEMORIALS
TRENTON NJ

STD5R277.CMP



ART STONE CO
ROCK ISLAND IL

STD5R278.CMP

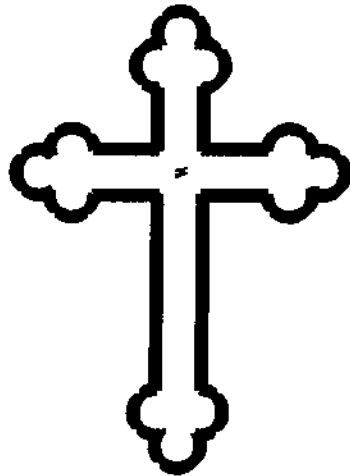

NICHOLSON MONUMENT CO
CLINTON OK

STD5R279.CMP

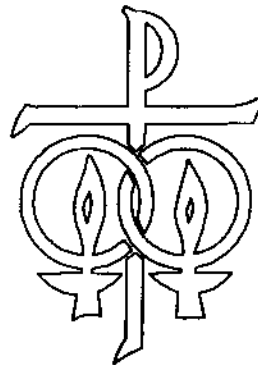

NICHOLSON MONUMENT CO
CLINTON OK

STD5R280.CMP

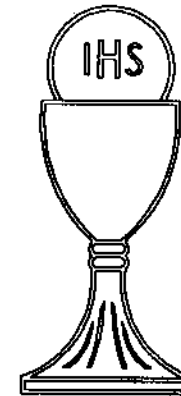

CARON GRANITE CO
PAWTUCKET RI

STD5R281.CMP

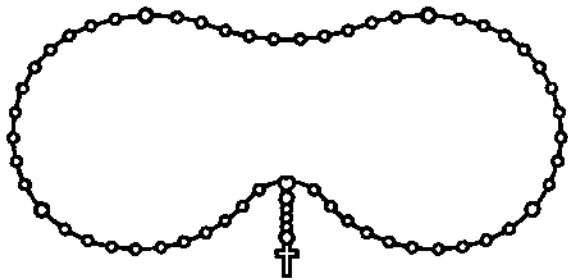

CARON GRANITE CO
PAWTUCKET RI

STD5R282 .CMP

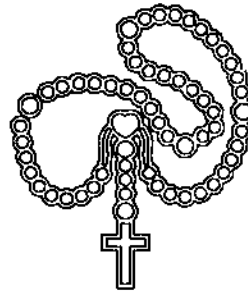

CARON GRANITE CO
PAWTUCKET RI

STD5R283 .CMP



CARON GRANITE CO
PAWTUCKET RI

STD5R284 .CMP

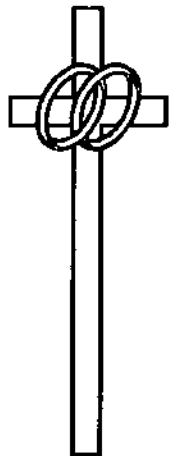

CARON GRANITE CO
PAWTUCKET RI

STD5R285 .CMP



CARON GRANITE CO
PAWTUCKET RI

STD5R286 .CMP

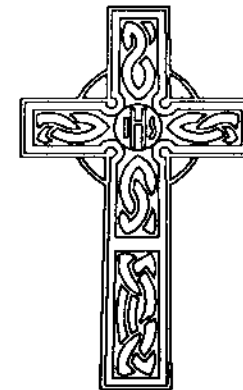

CARON GRANITE CO
PAWTUCKET RI

STD5R287 .CMP

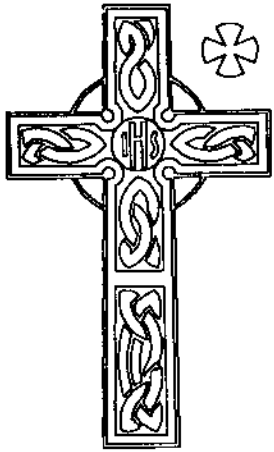

CARON GRANITE CO
PAWTUCKET RI

STD5R288 .CMP

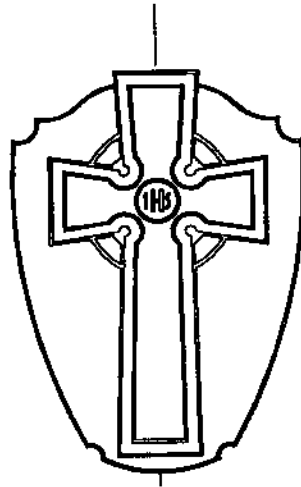

CARON GRANITE CO
PAWTUCKET RI

STD5R289 .CMP

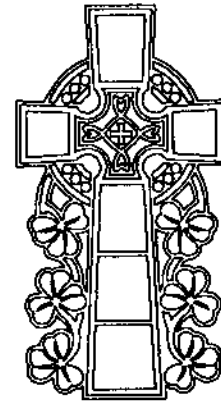

CARON GRANITE CO
PAWTUCKET RI

STD5R290 .CMP

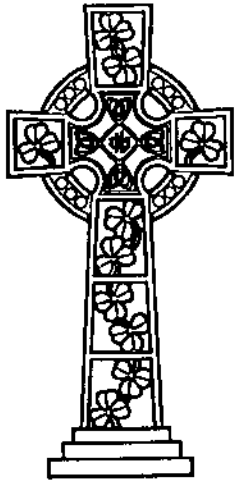

CARON GRANITE CO
PAWTUCKET RI

STD5R291 .CMP

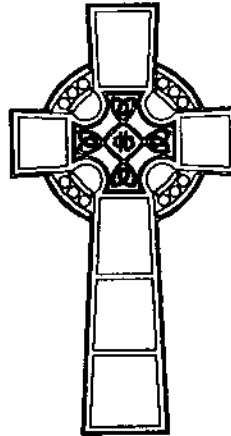

CARON GRANITE CO
PAWTUCKET RI

STD5R292 .CMP

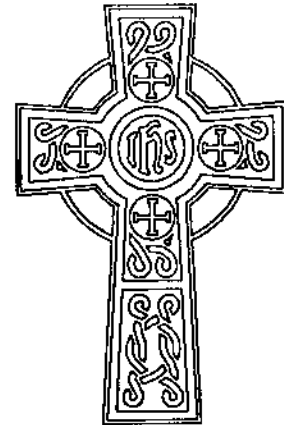

CARON GRANITE CO
PAWTUCKET RI

STD5R293 .CMP



CARON GRANITE CO
PAWTUCKET RI

STD5R294 .CMP



CARON GRANITE CO
PAWTUCKET RI

STD5R295 .CMP

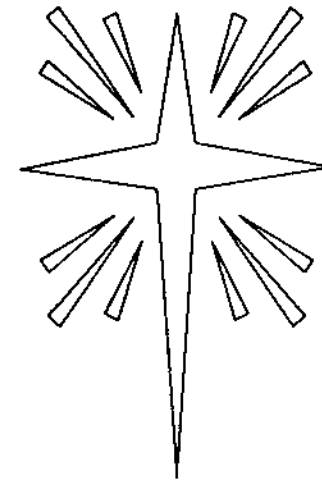

PLOUFF'S MONUMENT CO
ST. ALBANS VT

STD5R296 .CMP

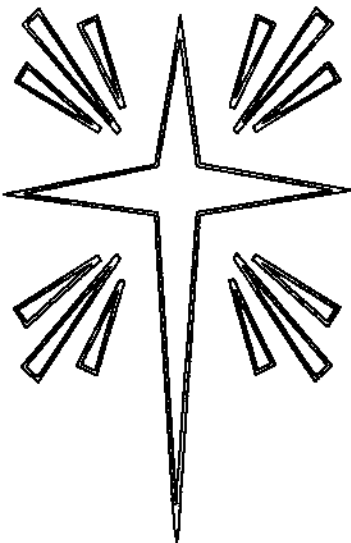

PLOUFF'S MONUMENT CO
ST. ALBANS VT

STD5R297 .CMP

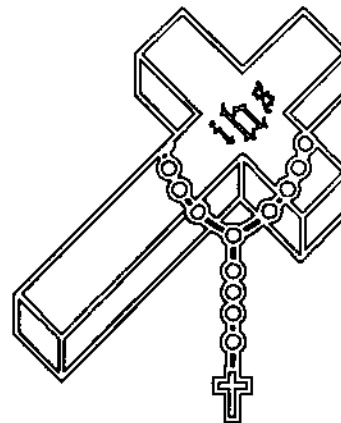

PLOUFF'S MONUMENT CO
ST. ALBANS VT

STD5R298 .CMP

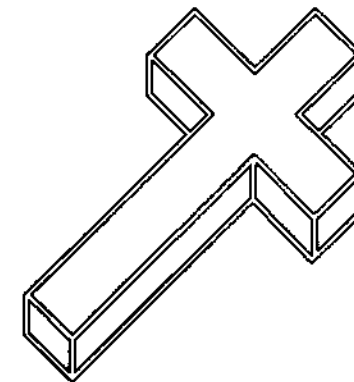

PLOUFF'S MONUMENT CO
ST. ALBANS VT

STD5R299 .CMP

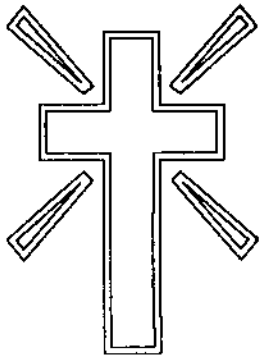

PLOUFF'S MONUMENT CO
ST. ALBANS VT

STD5R300.CMP

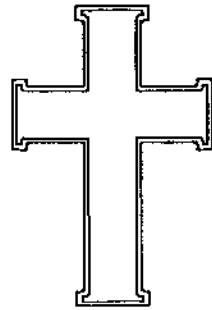

PLOUFF'S MONUMENT CO
ST. ALBANS VT

STD5R301.CMP

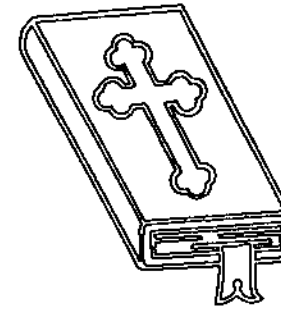

PHOENIXVILLE MEMORIAL WORKS
PHOENIXVILLE PA

STD5R302.CMP

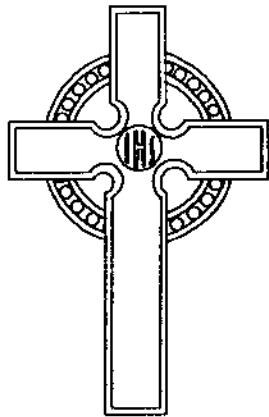

PHOENIXVILLE MEMORIAL WORKS
PHOENIXVILLE PA

STD5R303.CMP

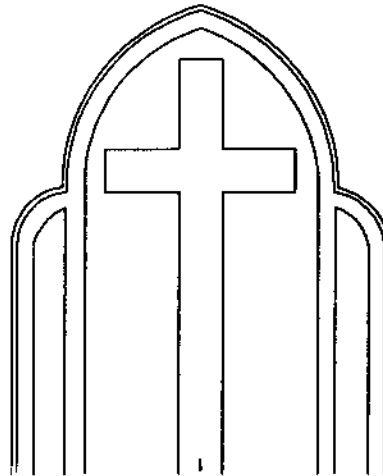

PHOENIXVILLE MEMORIAL WORKS
PHOENIXVILLE PA

STD5R304.CMP

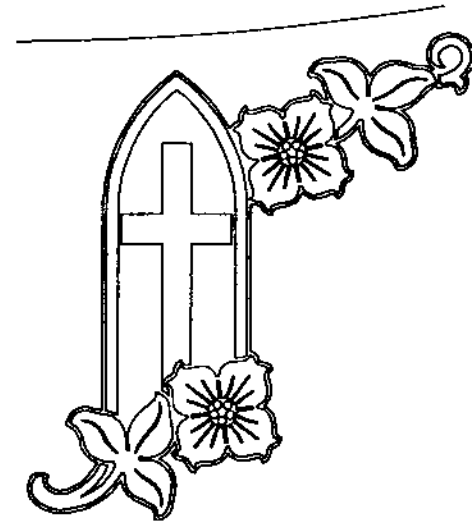

PHOENIXVILLE MEMORIAL WORKS
PHOENIXVILLE PA

STD5R305.CMP

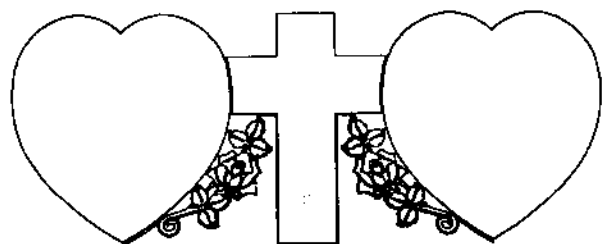

CHILDS & CHILDS GRANITE CO
ELBERTON GA
STD5R306 .CMP

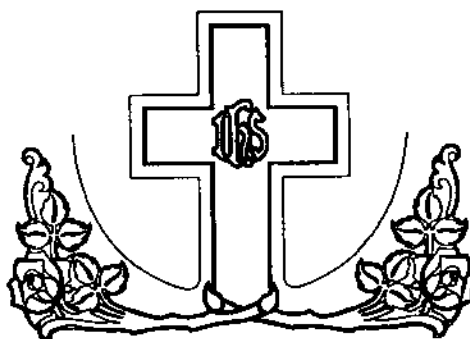

CHILDS & CHILDS GRANITE CO
ELBERTON GA
STD5R307 .CMP

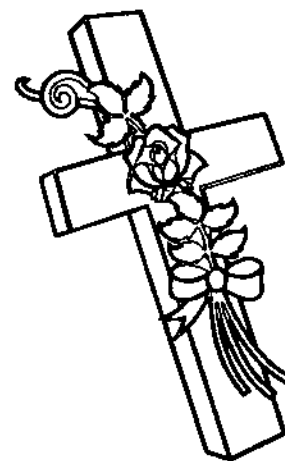

CHILDS & CHILDS GRANITE CO
ELBERTON GA
STD5R308 .CMP

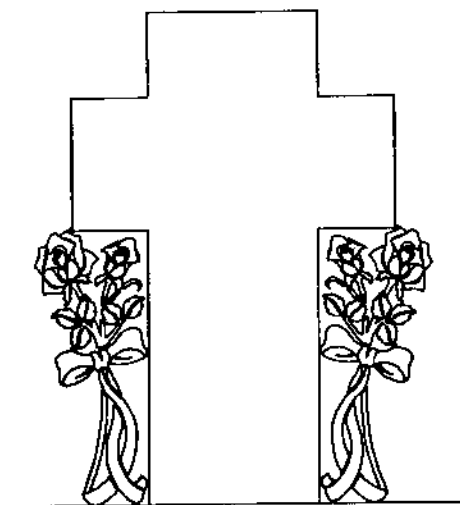

CHILDS & CHILDS GRANITE CO
ELBERTON GA
STD5R309 .CMP

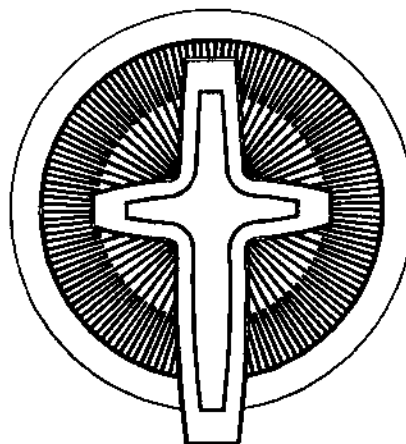

CHILDS & CHILDS GRANITE CO
ELBERTON GA
STD5R310 .CMP

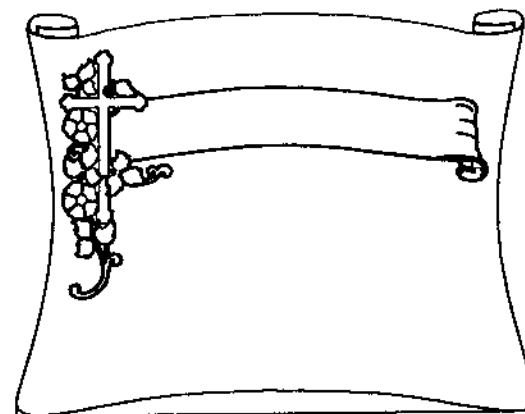

CHILDS & CHILDS GRANITE CO
ELBERTON GA
STD5R311 .CMP

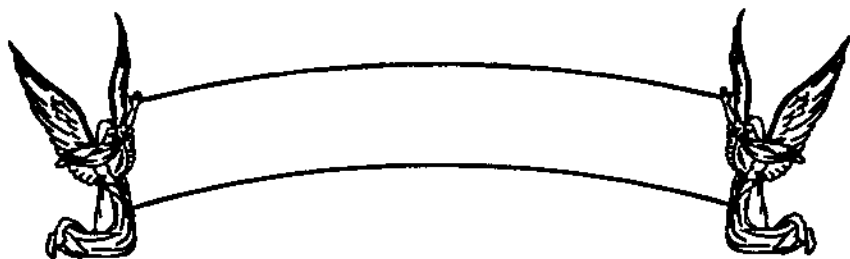

MC GEE MONUMENT CO
MORRILTON AR

STD5R312.CMP

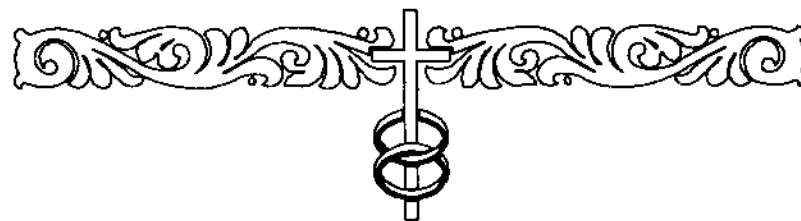

KEITH MONUMENT CO
BOWLING GREEN KY

STD5R313.CMP

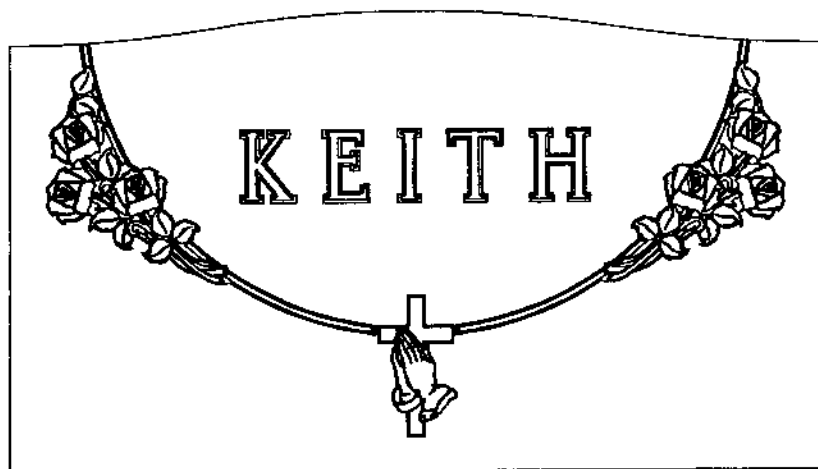

KEITH MONUMENT CO
BOWLING GREEN KY

STD5R314.CMP

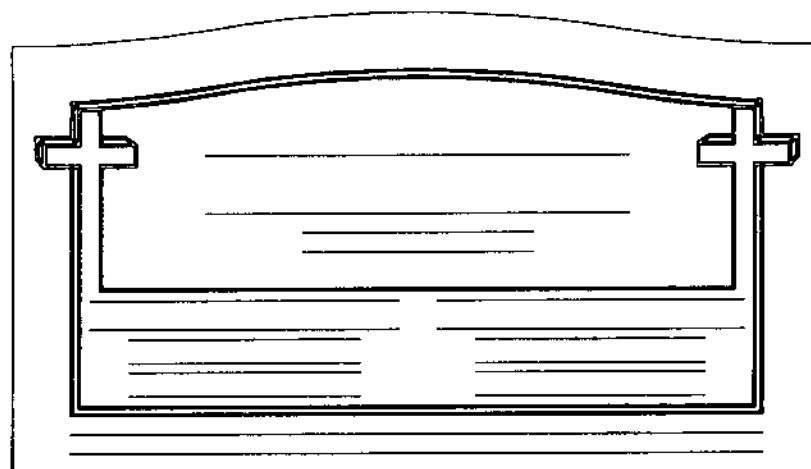

KEITH MONUMENT CO
BOWLING GREEN KY

STD5R315.CMP

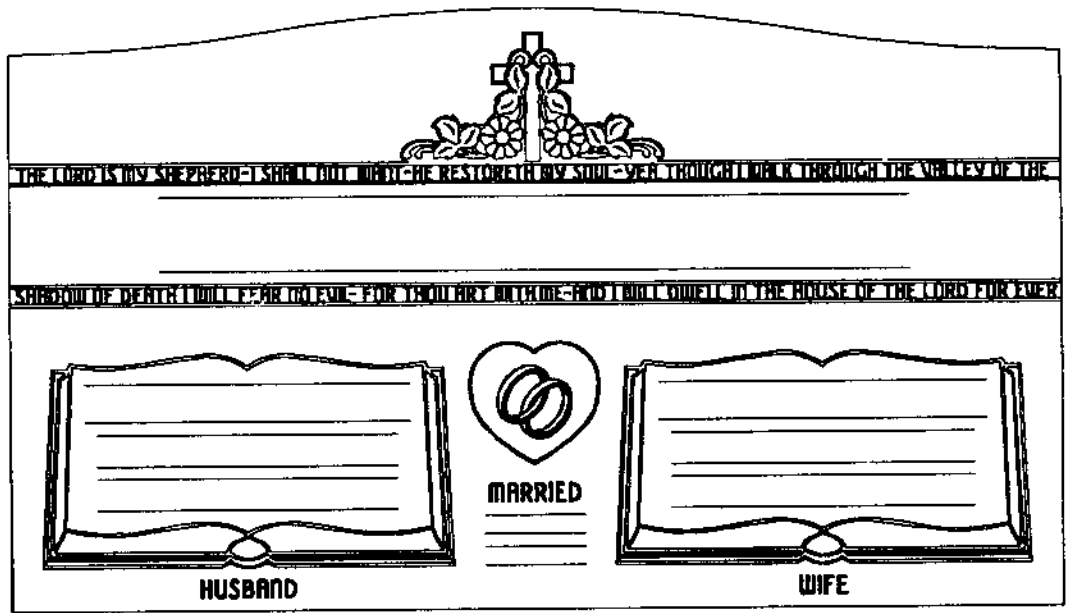

KEITH MONUMENT CO
BOWLING GREEN KY

STD5R316 .CMP



PEEBLES MONUMENT CO
PEEBLES OH

STD5R317 .CMP

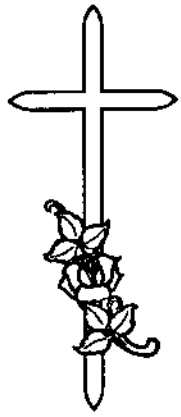

PEEBLES MONUMENT CO
PEEBLES OH

STD5R318 .CMP

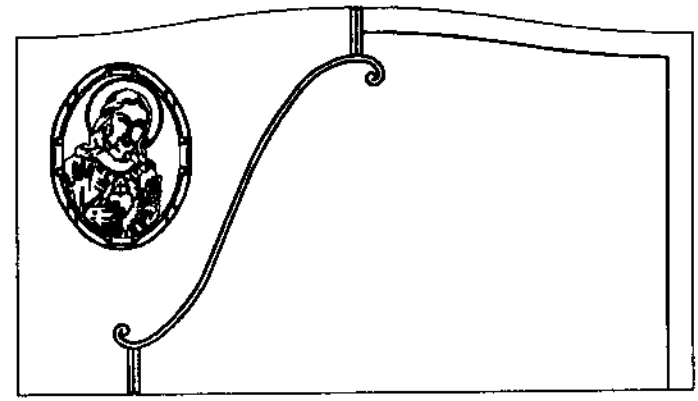

CHERRY VALLEY MEMORIALS
CHERRY VALLEY NY

STD5R319 .CMP

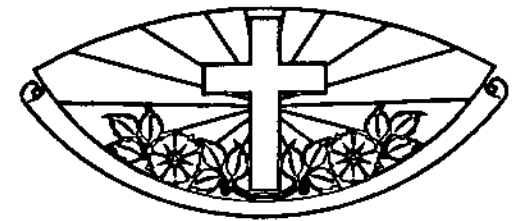

CHERRY VALLEY MEMORIALS
CHERRY VALLEY NY

STD5R320 .CMP



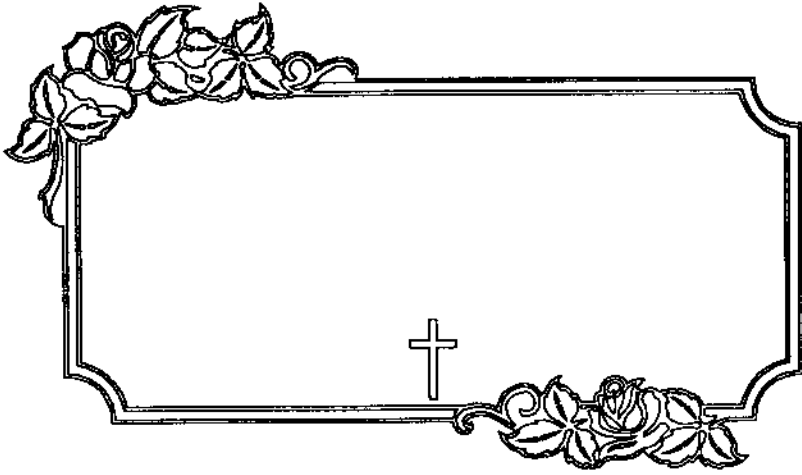

CHERRY VALLEY MEMORIALS
CHERRY VALLEY NY

STD5R321.CMP

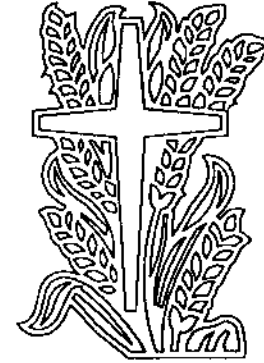

CHERRY VALLEY MEMORIALS
CHERRY VALLEY NY

STD5R322.CMP

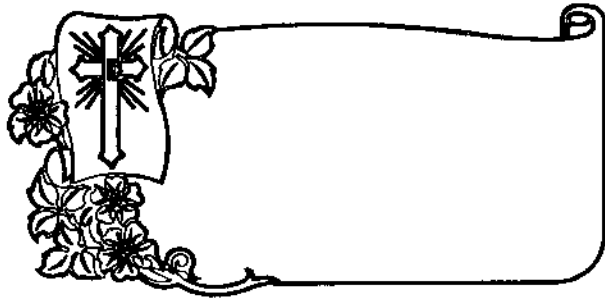

CHERRY VALLEY MEMORIALS
CHERRY VALLEY NY

STD5R323.CMP



CHERRY VALLEY MEMORIALS
CHERRY VALLEY NY

STD5R324.CMP

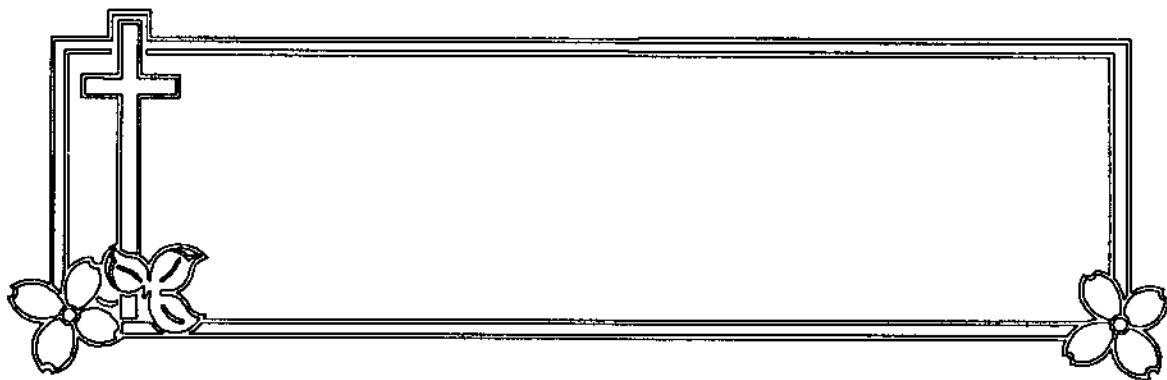

HENRY OLSON MEMORIALS
LOVES PARK IL

STD5R325 .CMP

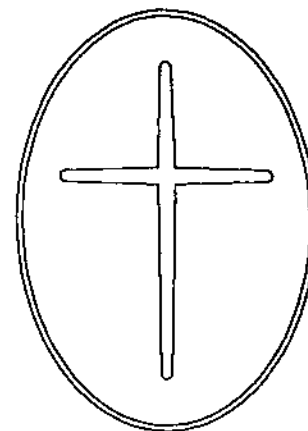

ROCK OF AGES CANADA
BEEBE QUEBEC CANADA

STD5R326 .CMP



ROCK OF AGES CANADA
BEEBE QUEBEC CANADA

STD5R327 .CMP



ADAMS MEMORIALS
CHARLESTON IL

STD5R328 .CMP



ADAMS MEMORIALS
CHARLESTON IL

STD5R329 .CMP

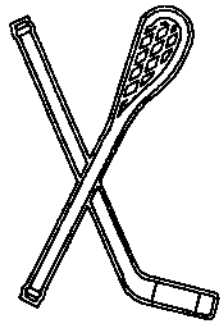

STAFFORD MONUMENTS
WHITBY ONTARIO
STD5S001 .CMP

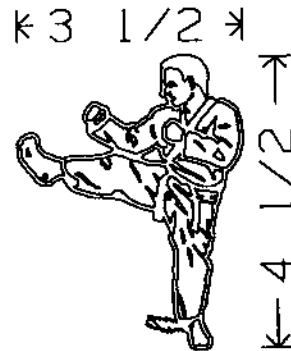

TULSA MONUMENT CO.
TULSA OK STD5S002 .CMP

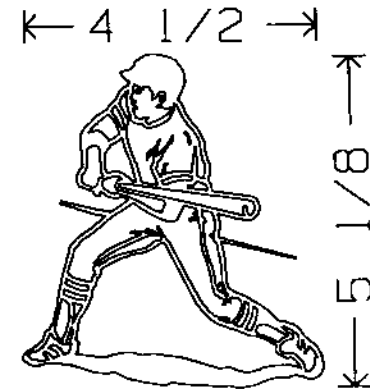

TULSA MONUMENT CO.
TULSA OK STD5S003 .CMP

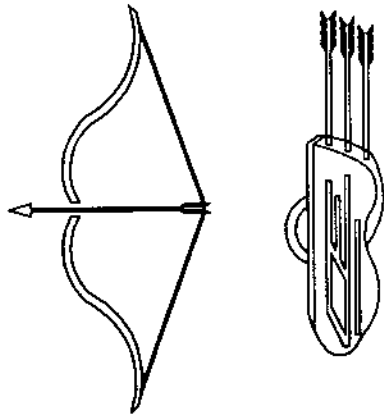

EVERGREEN MEMORIALS
CALGARY ALBERTA
STD5S004 .CMP



SAXON GRANITE
ELBERTON GA STD5S005 .CMP

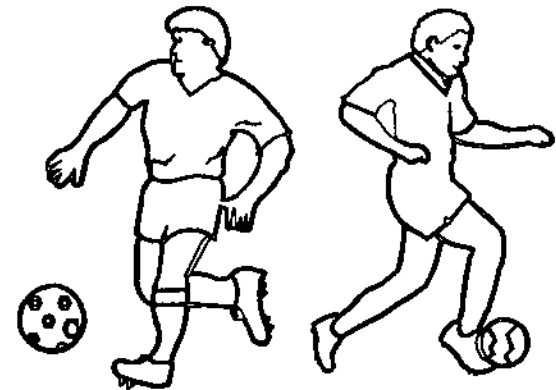

N.C. MARBLE & GRANITE
CLINTON NC
STD5S006 .CMP

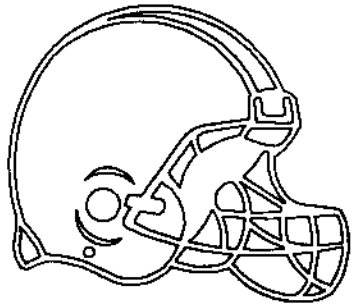

3.5 X 3.25

ARCHIE MONUMENT & STONE
WATERTOWN WI

STD5S007.CMP

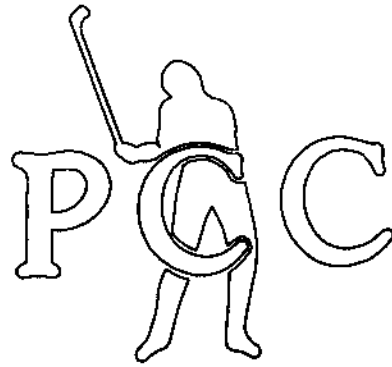

BREWER MONUMENT CO.
PERRYVILLE MO

STD5S008.CMP



BREWER MONUMENT CO.
PERRYVILLE MO

STD5S009.CMP

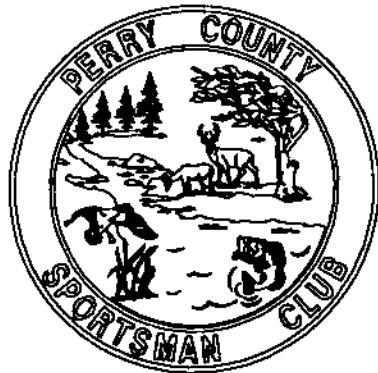

BREWER MONUMENT CO.
PERRYVILLE MO

STD5S010.CMP

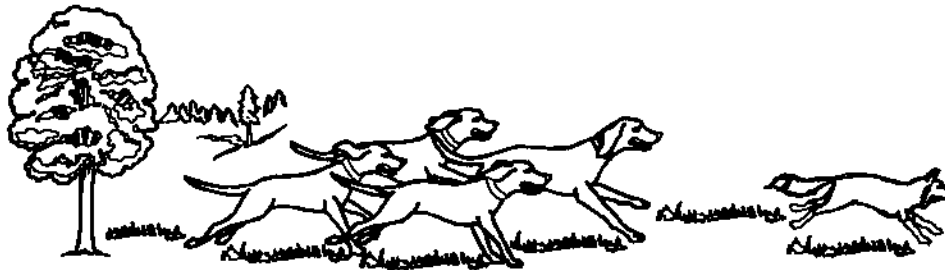

AMITE MARBLE & GRANITE

AMITE LA

STD5S011.CMP

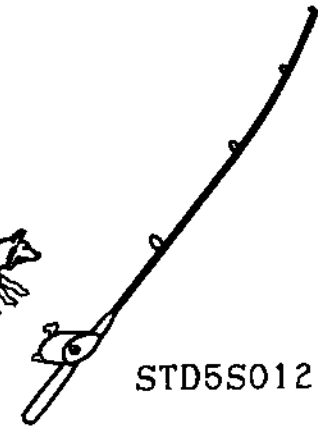

STD5S012.CMP

AMITE MARBLE & GRANITE
AMITE LA



AMITE MARBLE & GRANITE
AMITE LA STD5S013.CMP

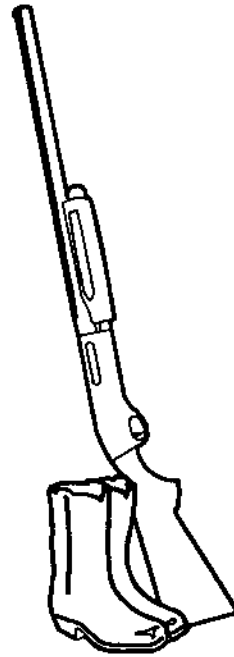

AMITE MARBLE & GRANITE
AMITE LA STD5S014.CMP

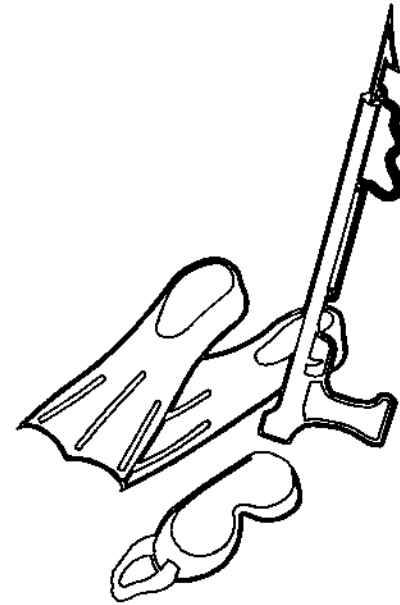

AMITE MARBLE & GRANITE
AMITE LA STD5S015.CMP



EDWIN F. NICKOL
VERSAILLES OH STD5S016.CMP

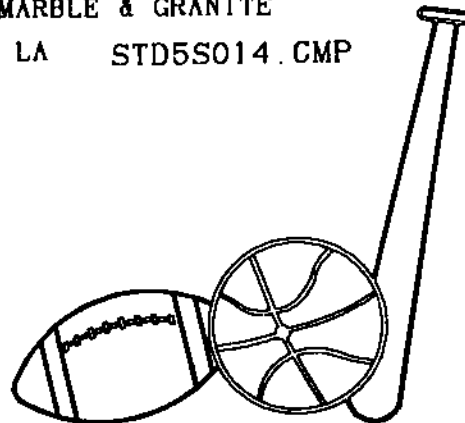

ERIE CITY MEMORIALS
ERIE PA STD5S017.CMP

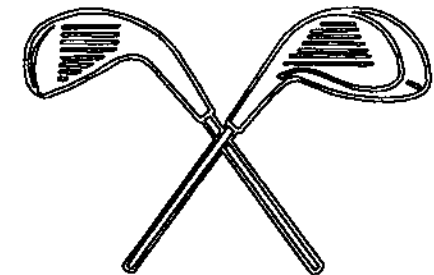

MASTERCARVED MEMORIALS
CLAY CENTER KS
STD5S018.CMP

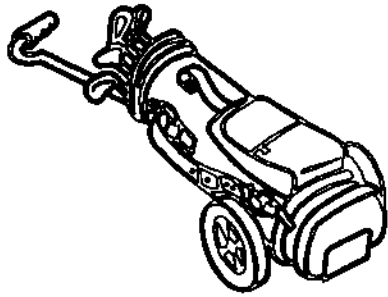

MASTERCARVED MEMORIALS
CLAY CENTER KS

STD5S019.CMP

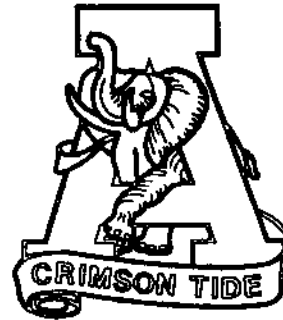

ADVANCED MEMORIAL DESIGN
MORRISTOWN TN

STD5S020.CMP

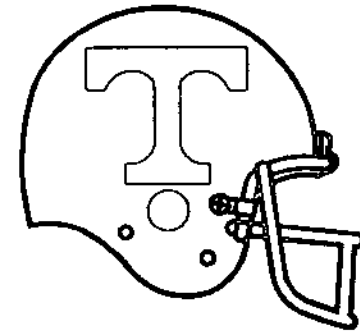

ADVANCED MEMORIAL DESIGN
MORRISTOWN TN

STD5S021.CMP



MILLIGAN MEMORIALS
COSHOCTON OH

STD5S022.CMP

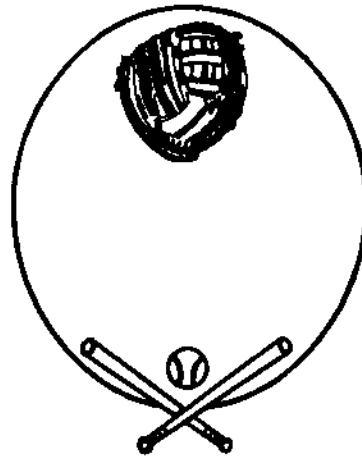

QUALITY-CUT MONUMENTAL DESIGNS
ELBERTON GA

STD5S023.CMP

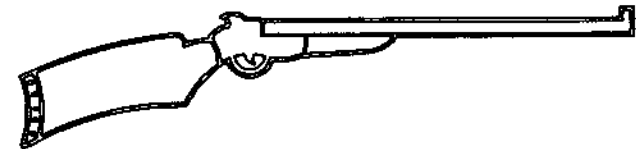

QUALITY-CUT MONUMENTAL DESIGNS
ELBERTON GA

STD5S024.CMP

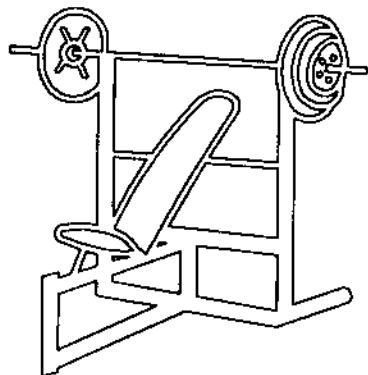

BOYCE MONUMENTAL SALES LTD
CARROLL IA

STD5S025.CMP



BOYCE MONUMENTAL SALES LTD
CARROLL IA

STD5S026.CMP



RMG STONE PRODUCTS
CASTLETON VT

STD5S027.CMP



LONGSTRETH MEMORIALS
GALION OH

STD5S028.CMP

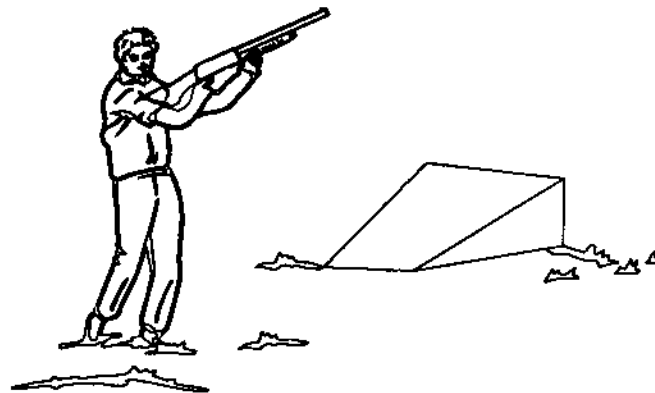

J.W. REYNOLDS MONUMENTS
VIENNA IL

STD5S029.CMP

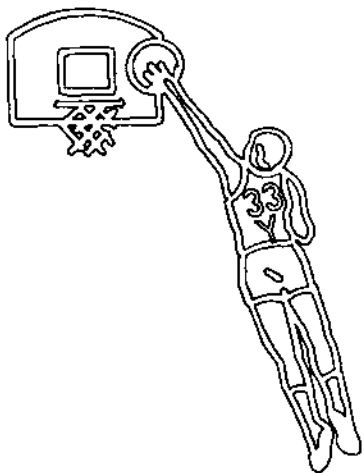

CROWN MONUMENT
WARREN OH

STD5S030 .CMP

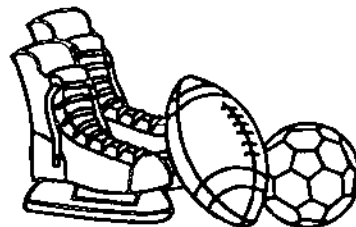

SMYTH MEMORIAL CO
CHATHAM ONTARIO CANADA

STD5S031 .CMP



MILWAUKEE MEMORIAL CO
MILWAUKEE WI

STD5S032 .CMP



McGARRY MEMORIALS
CHORLTON MANCHESTER UK

STD5S033 .CMP

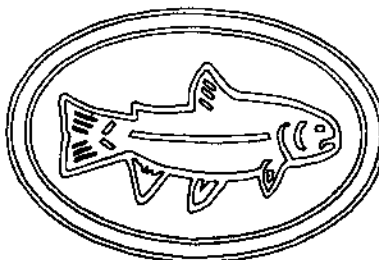

BARRE MEMORIALS
HYDE PARK NY

STD5S034 .CMP

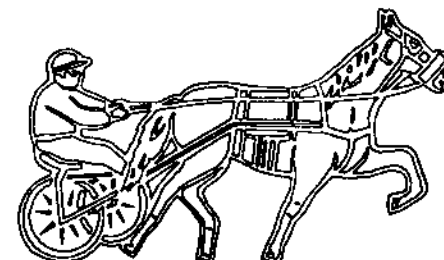

BARRE MEMORIALS
HYDE PARK NY

STD5S035 .CMP



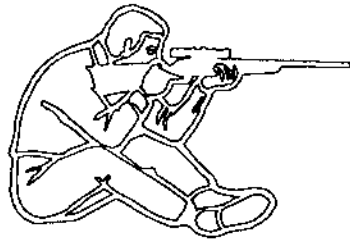

BEESLEY MONUMENT CO
PROVO UT

STD5S036 .CMP



BEESLEY MONUMENT CO
PROVO UT

STD5S037 .CMP

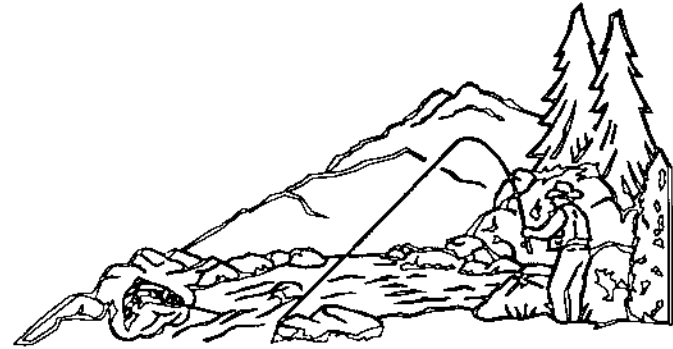

BROWN MONUMENT
LOGAN UT

STD5S038 .CMP

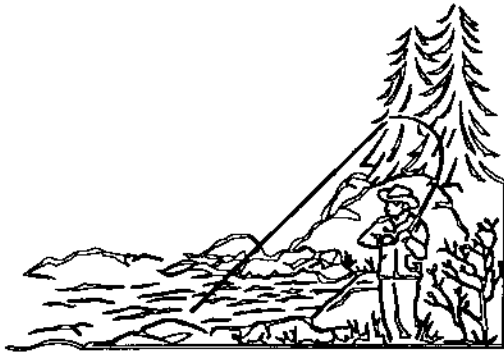

BROWN MONUMENT
LOGAN UT

STD5S039 .CMP

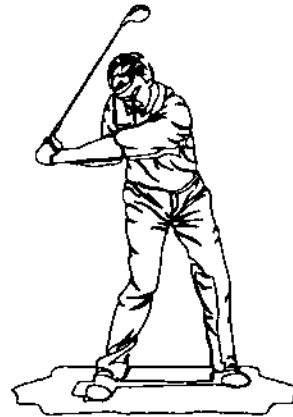

MASTERCRAFT MEMORIALS
RICHMOND IN

STD5S040 .CMP



MASTERCRAFT MEMORIALS
RICHMOND IN

STD5S041 .CMP

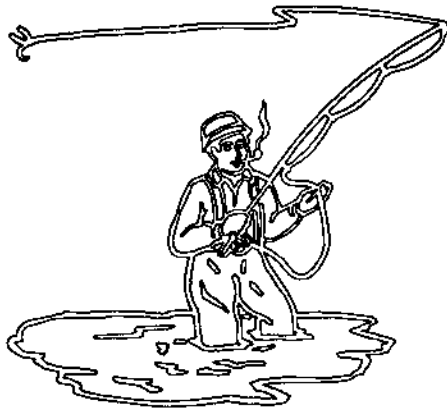

TROY MARBLE & GRANITE WORKS
TROY PA

STD5S042.CMP

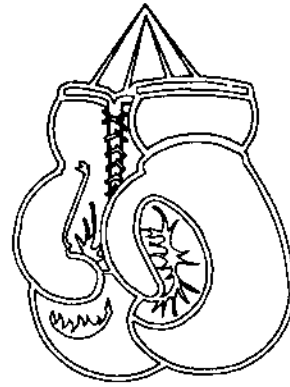

L. J. SERVICES
CHERRY VALLEY NY

STD5S043.CMP

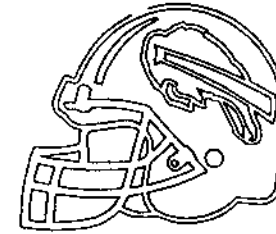

L. J. SERVICES
CHERRY VALLEY NY

STD5S044.CMP

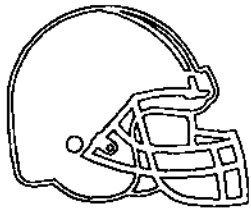

L. J. SERVICES
CHERRY VALLEY NY

STD5S045.CMP

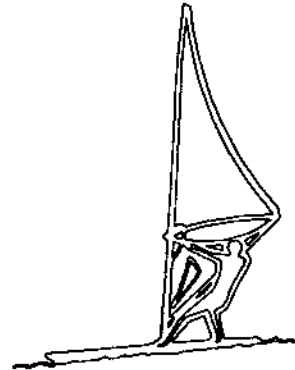

RINKER & FRYE MEMORIALS
MT. JACKSON VA

STD5S046.CMP

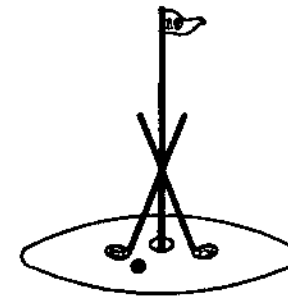

BRACOLONI CUSTOM MEMORIALS
TRENTON NJ

STD5S047.CMP

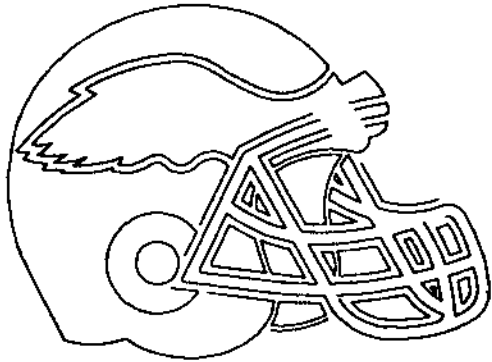

BRACOLONI CUSTOM MEMORIALS
TRENTON NJ

STD5S048 .CMP

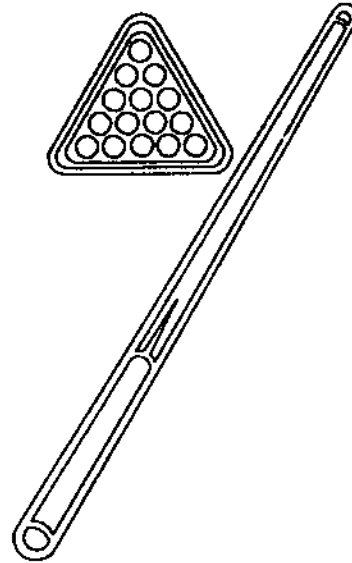

ART STONE CO
ROCK ISLAND IL

STD5S049 .CMP

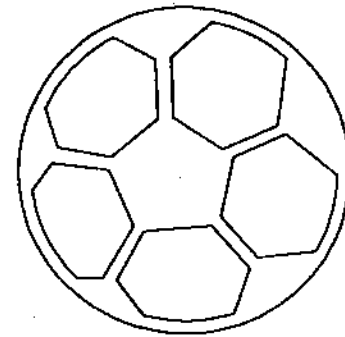

ART STONE CO
ROCK ISLAND IL

STD5S050 .CMP

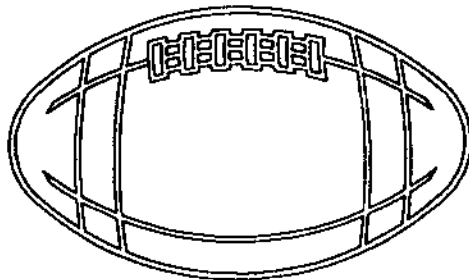

CARON GRANITE CO
PAWTUCKET RI

STD5S051 .CMP

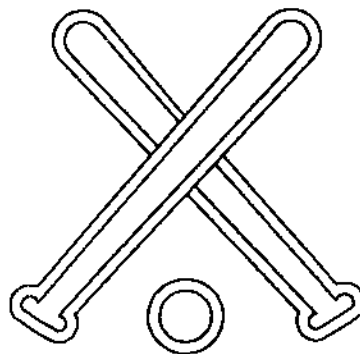

PLOUFF'S MONUMENT CO
ST. ALBANS VT

STD5S052 .CMP

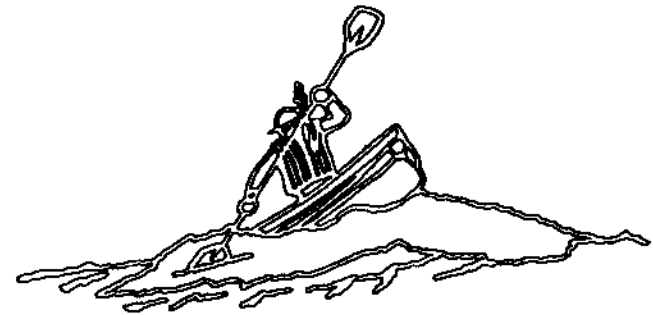

OREGON GRANITE CO
MEDFORD OR

STD5S053 .CMP

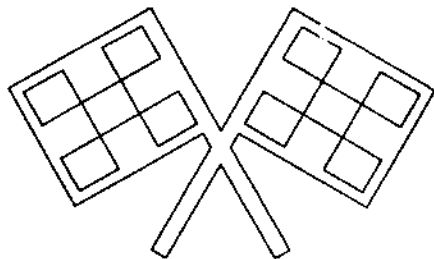

CHERRY VALLEY MEMORIALS
CHERRY VALLEY NY

STD5S054 .CMP

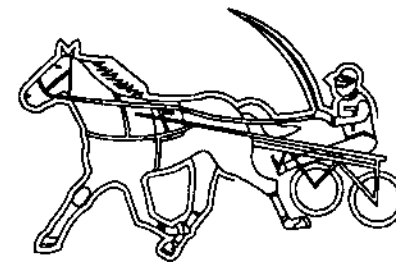

HENRY OLSON MEMORIALS
LOVES PARK IL

STD5S055 .CMP

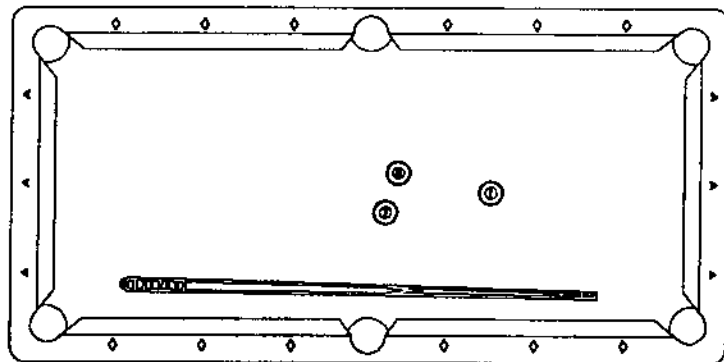

ADAMS MEMORIALS
CHARLESTON IL

STD5S056 .CMP

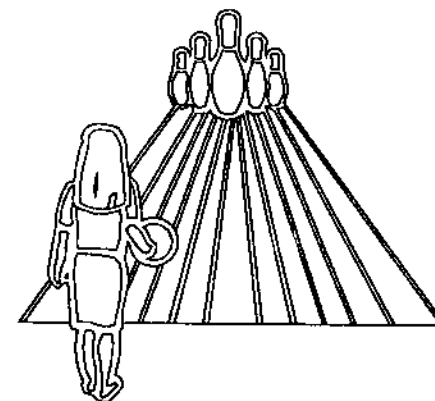

WEARLY MONUMENTS
MUNCIE IN

STD5S057 .CMP



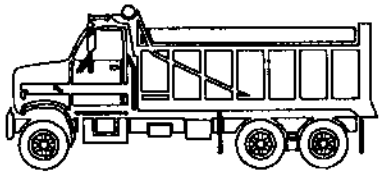

STAFFORD MONUMENTS
WHITBY ONTARIO CANADA

STD5V001 .CMP

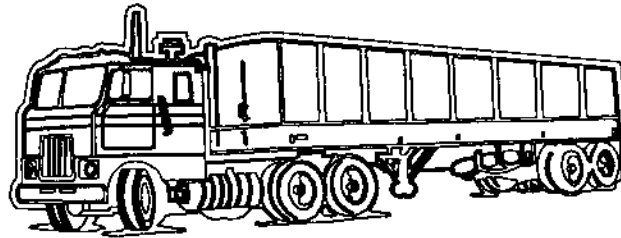

STAFFORD MONUMENTS
WHITBY ONTARIO CANADA

STD5V002 .CMP



TULSA MONUMENT CO
TULSA OK

STD5V003 .CMP

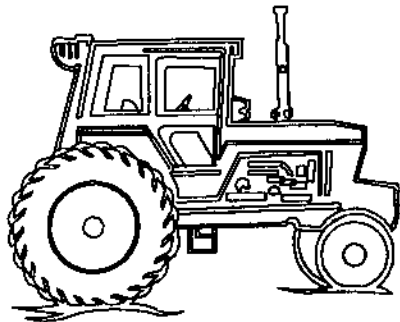

SAXON GRANITE
ELBERTON GA

STD5V004 .CMP

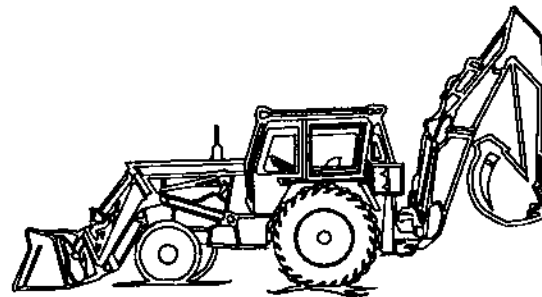

SAXON GRANITE
ELBERTON GA

STD5V005 .CMP

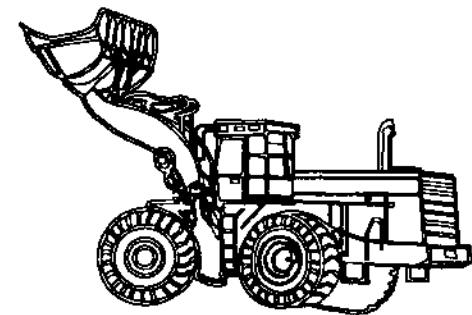

SAXON GRANITE
ELBERTON GA

STD5V006 .CMP

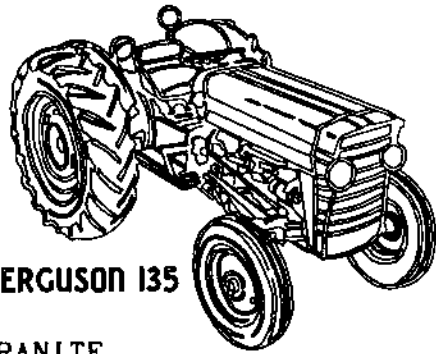

MASSEY FERGUSON 135

SAXON GRANITE
ELBERTON GA

STD5V007.CMP

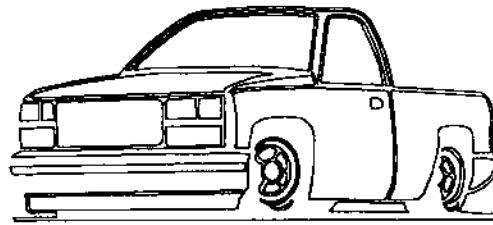

STANDARD GRANITE
ELBERTON GA

STD5V008.CMP

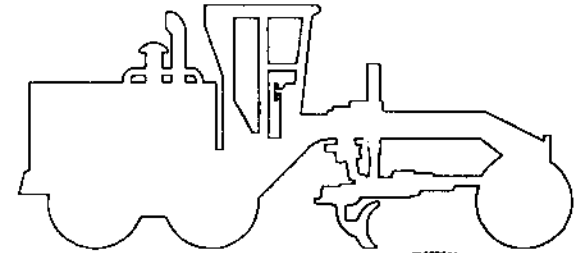

STANDARD GRANITE
ELBERTON GA

STD5V009.CMP

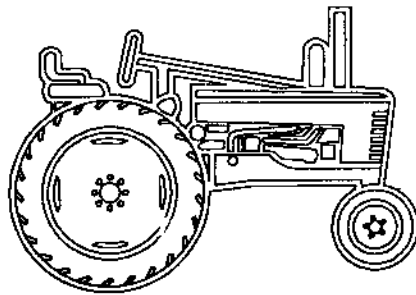

CENTRAL GRANITE CO.
ELBERTON GA

STD5V010.CMP

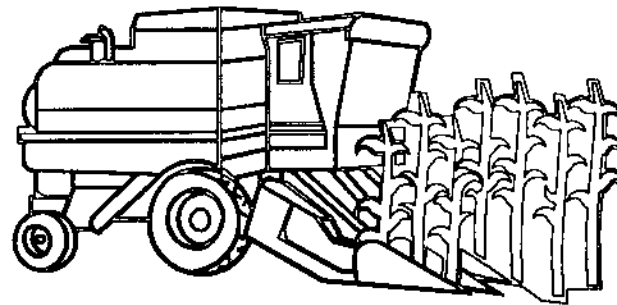

N.C. MARBLE & GRANITE
CLINTON NC

STD5V011.CMP



N.C. MARBLE & GRANITE
CLINTON NC

STD5V012.CMP



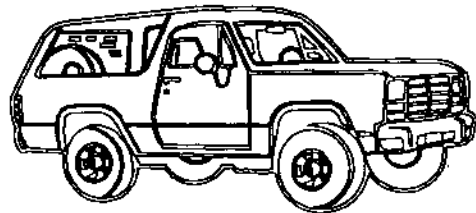

DAWSON MONUMENT CO.
WINFIELD KS

STD5V013.CMP

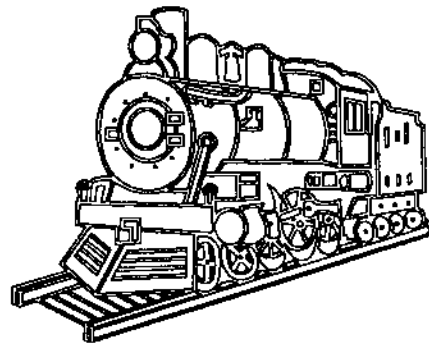

DAWSON MONUMENT CO.
WINFIELD KS

STD5V014.CMP

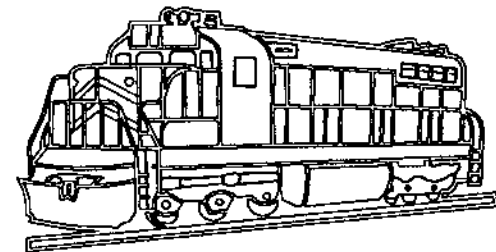

DAWSON MONUMENT CO.
WINFIELD KS

STD5V015.CMP

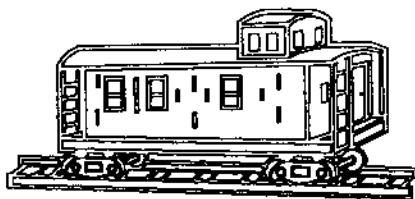

DAWSON MONUMENT CO.
WINFIELD KS

STD5V016.CMP

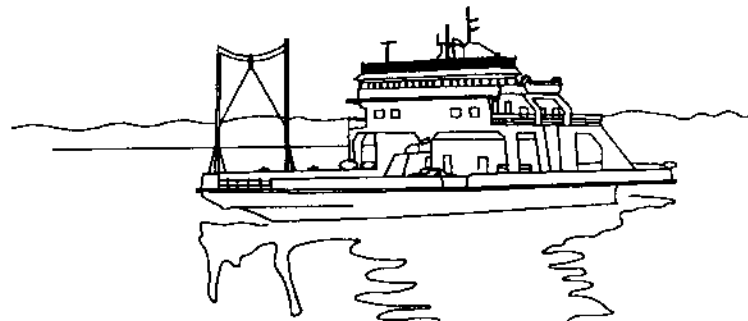

GRANITE LACROIX
VIMONT-LAVAL QUEBEC

STD5V017.CMP

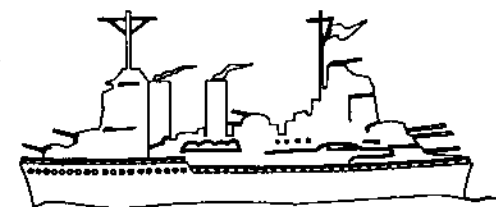

GRANITE LACROIX
VIMONT-LAVAL QUEBEC

STD5V018.CMP

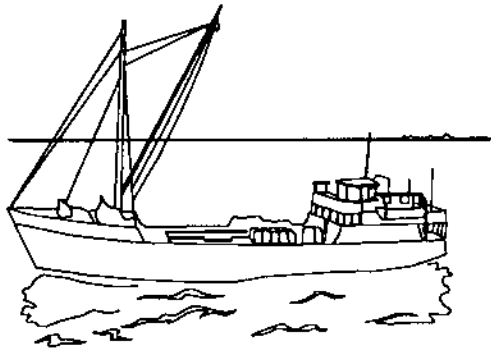

GRANITE LACROIX
VIMONT-LAVAL QUEBE
STD5V019.CMP

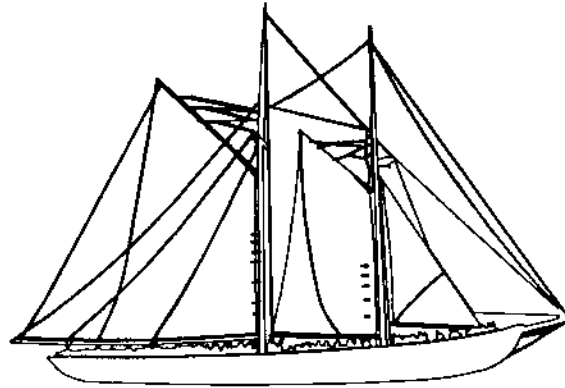

GRANITE LACROIX
VIMONT-LAVAL QUEBEC
STD5V020.CMP

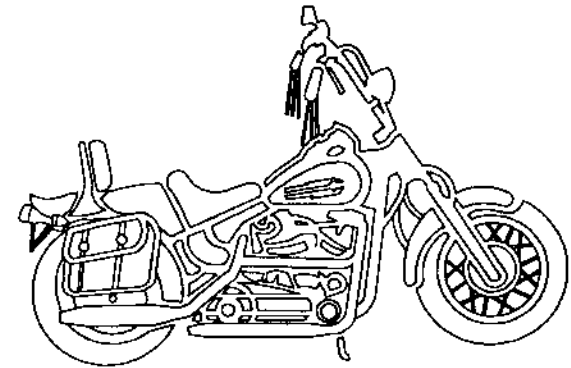

BREWER MONUMENT CO.
PERRYVILLE MO STD5V021.CMP

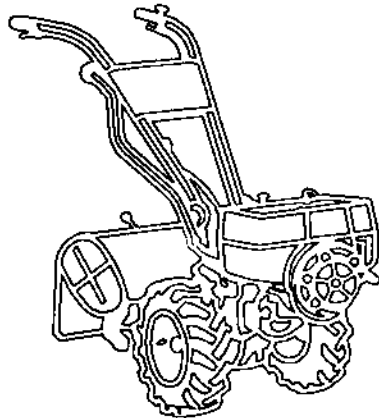

AMITE MARBLE & GRANITE
AMITE LA STD5V022.CMP

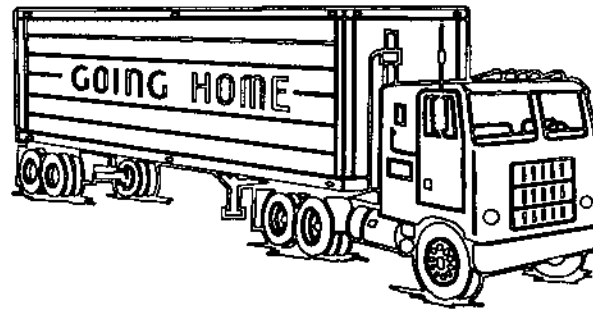

EDWIN F NICKOL
VERSAILLES OH STD5V023.CMP



ERIE CITY MEMORIALS
ERIE PA STD5V024.CMP



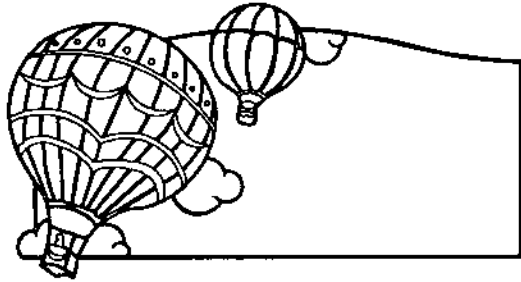

ERIE CITY MEMORIALS
ERIE PA STD5V025 .CMP

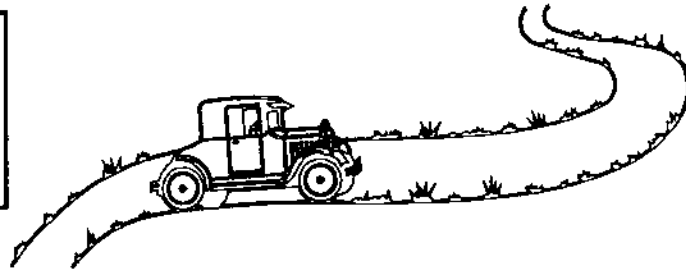

WOODWARD MONUMENTS
VICI OK STD5V026 .CMP

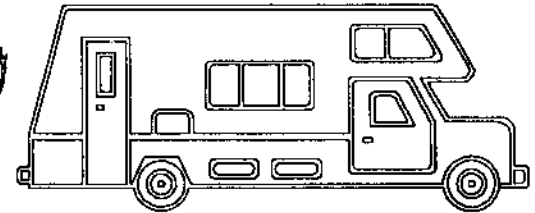

RUST-UNGER MONUMENTS
COLUMBUS IN STD5V027 .CMP

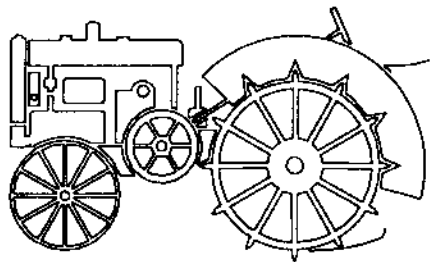

RUST-UNGER MONUMENTS
COLUMBUS IN STD5V028 .CMP

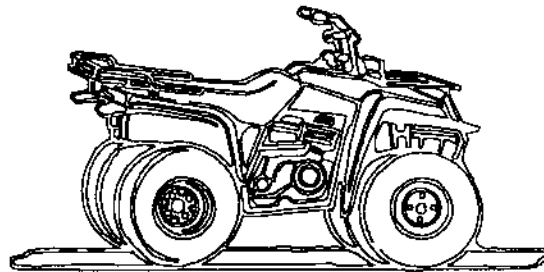

STATEWIDE MEMORIALS
BRUNSWICK STD5V029 .CMP

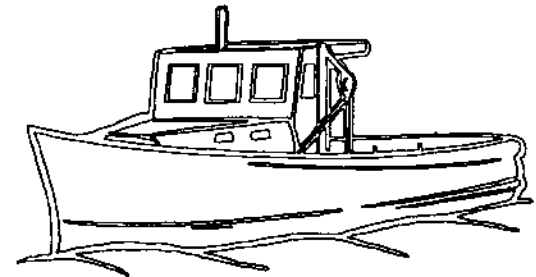

STATEWIDE MEMORIALS
BRUNSWICK STD5V030 .CMP



STATEWIDE MEMORIALS
BRUNSWICK ME

STD5V031.CMP

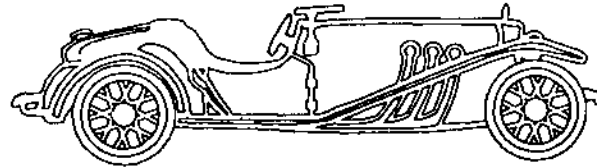

SEAMON-POE MONUMENT CO.
SAN DIEGO CA

STD5V032.CMP

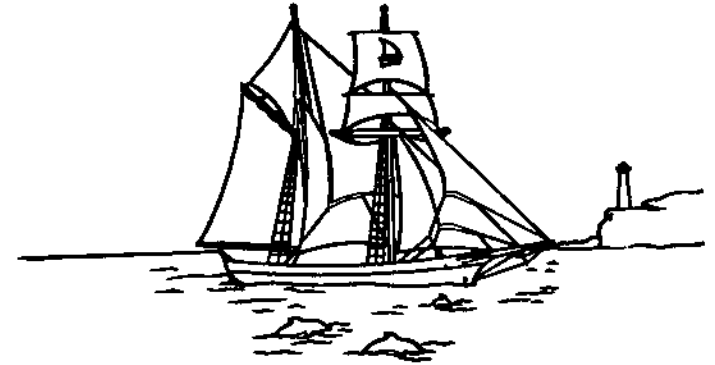

KEITH MONUMENT CO.
ELIZABETHTOWN KY

STD5V033.CMP

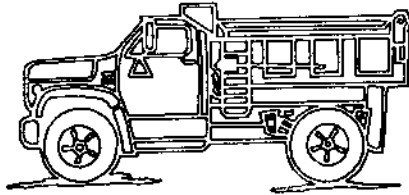

ROLLA MONUMENT CO.
ROLLA MO

STD5V034.CMP

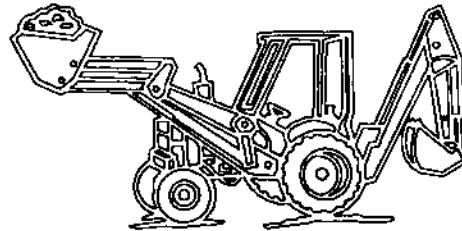

ROLLA MONUMENT CO.
ROLLA MO

STD5V035.CMP

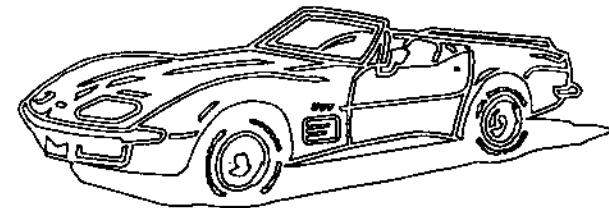

MILLIGAN MEMORIALS
COSHOCOTON OH

STD5V036.CMP



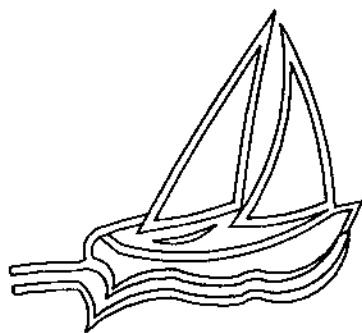

RMG STONE PRODUCTS
CASTLETON VT

STD5V037 .CMP

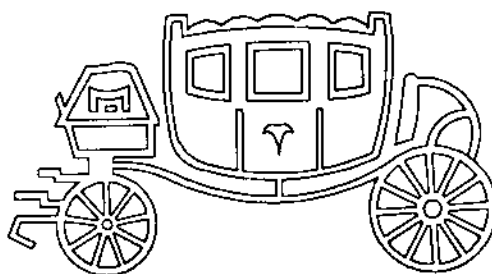

LONGSTRETH MEMORIALS
GALION OH

STD5V038 .CMP

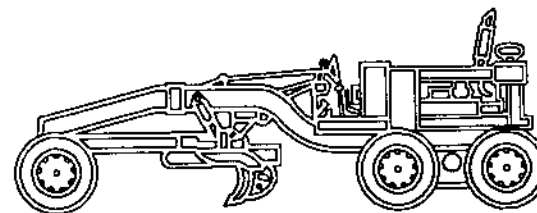

J. W. REYNOLDS MONUMENTS
VIENNA IL

STD5V039 .CMP

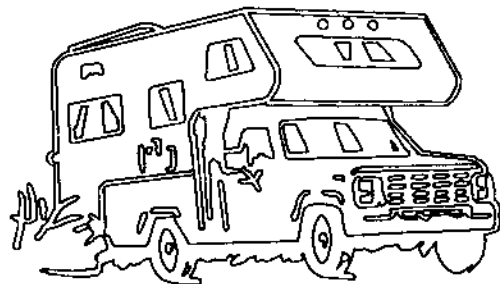

CROWN MONUMENT
WARREN OH

STD5V040 .CMP

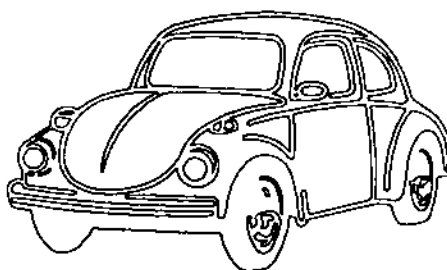

W. P. SIMMONS, INC
MT. AIRY NC

STD5V041 .CMP

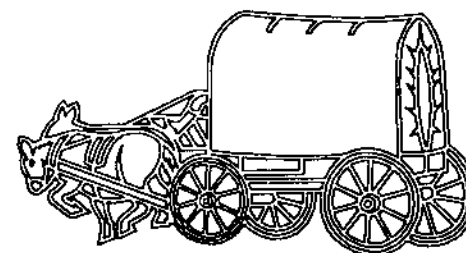

CAPITOL HILL MONUMENT
OKLAHOMA CITY OK

STD5V042 .CMP

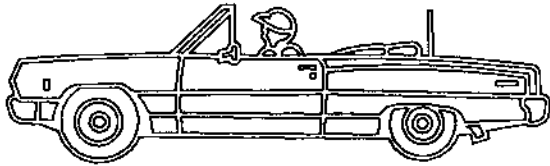

CAPITOL HILL MONUMENTS
OKLAHOMA CITY OK

STD5V043 .CMP

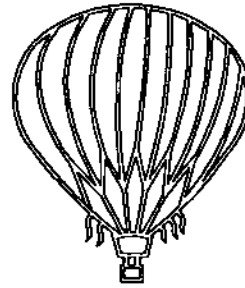

CAPITOL HILL MONUMENTS
OKLAHOMA CITY OK

STD5V044 .CMP



CAPITOL HILL MONUMENTS
OKLAHOMA CITY OK

STD5V045 .CMP



SMYTH MEMORIAL CO
CHATHAM ONTARIO CANADA

STD5V046 .CMP

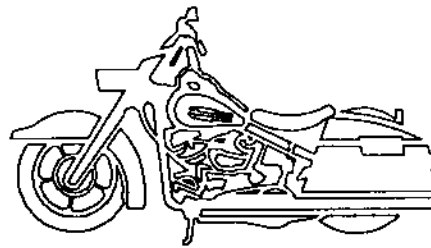

SMYTH MEMORIAL CO
CHATHAM ONTARIO CANADA

STD5V047 .CMP

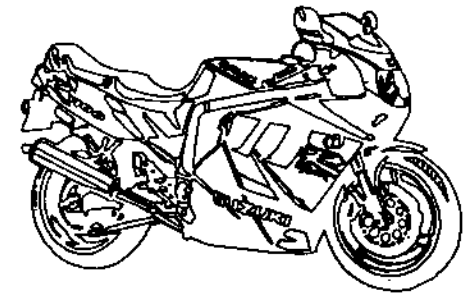

MILWAUKEE MEMORIAL CO
MILWAUKEE WI

STD5V048 .CMP

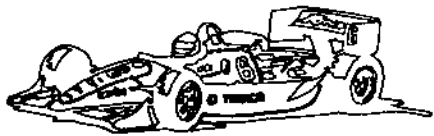

MILWAUKEE MEMORIAL CO
MILWAUKEE WI

STD5V049 .CMP



MILWAUKEE MEMORIAL CO
MILWAUKEE WI

STD5V050 .CMP

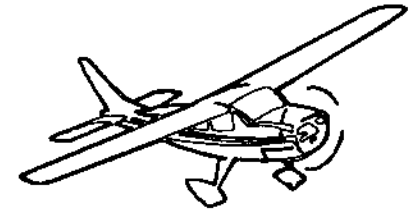

MILWAUKEE MEMORIAL CO
MILWAUKEE WI

STD5V051 .CMP



MOORE MONUMENT CO
CHILLICOTHE MO

STD5V052 .CMP

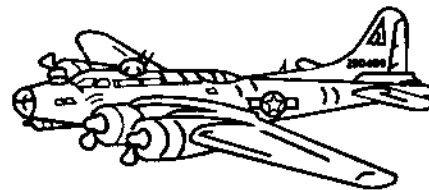

MOORE MONUMENT CO
CHILLICOTHE MO

STD5V053 .CMP



MOORE MONUMENT CO
CHILLICOTHE MO

STD5V054 .CMP

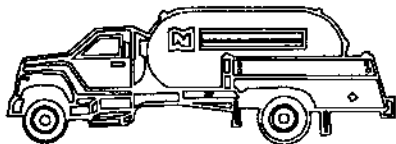

JAMESTOWN MONUMENT
JAMESTOWN ND

STD5V055 .CMP

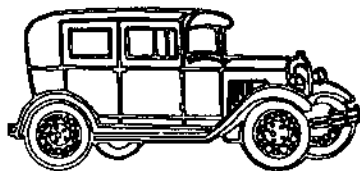

1929 MODEL A
FORD

JAMESTOWN MONUMENT
JAMESTOWN ND

STD5V056 .CMP

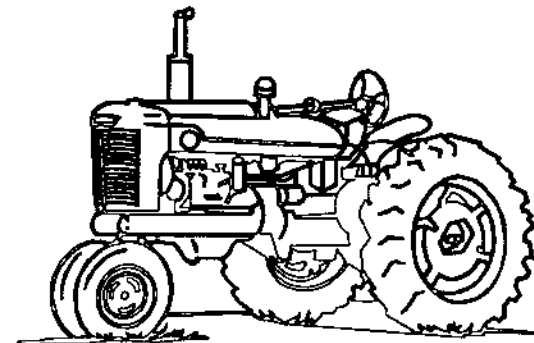

JAMESTOWN MONUMENT
JAMESTOWN ND

STD5V057 .CMP

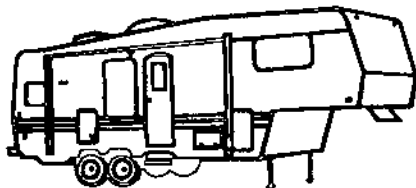

JAMESTOWN MONUMENT
JAMESTOWN ND

STD5V058 .CMP

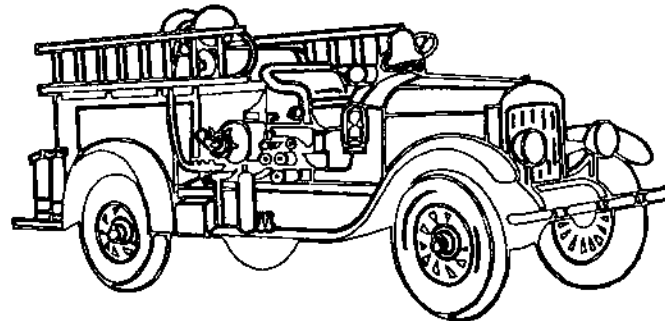

JAMESTOWN MONUMENT
JAMESTOWN ND

STD5V059 .CMP

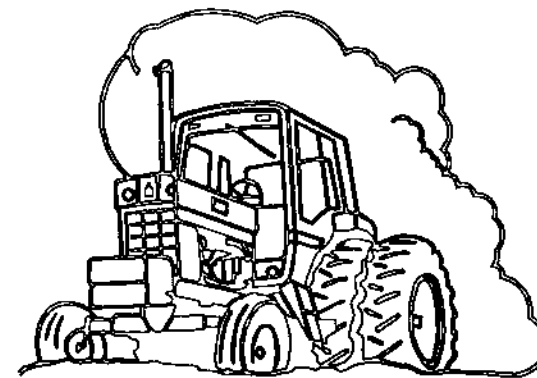

JAMESTOWN MONUMENT
JAMESTOWN ND

STD5V060 .CMP



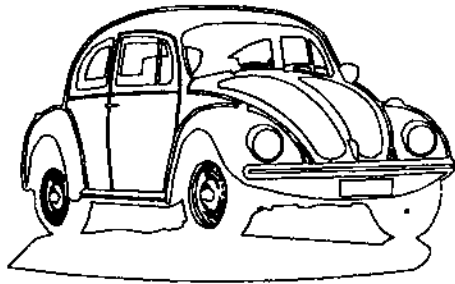

McGARRY MEMORIALS
CHORLTON MANCHESTER UK

STD5V061 .CMP

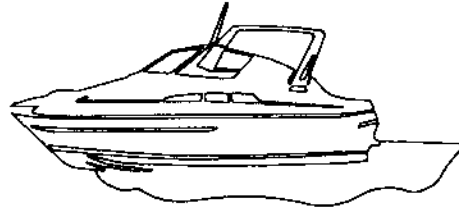

McGARRY MEMORIALS
CHORLTON MANCHESTER UK

STD5V062 .CMP

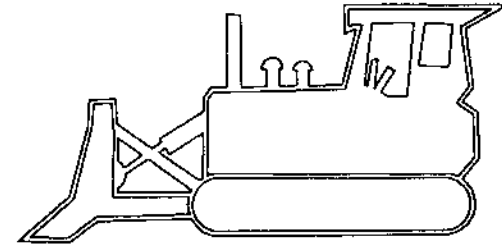

WOODSIDE GRANITE
ALBION NY

STD5V063 .CMP

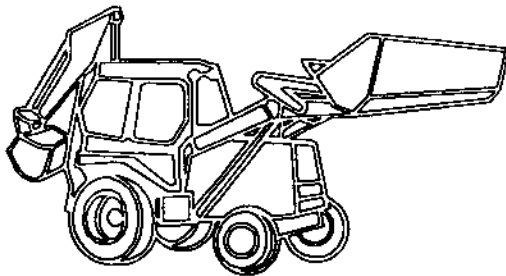

LEXINGTON GRANITE CO
LEXINGTON KY

STD5V064 .CMP

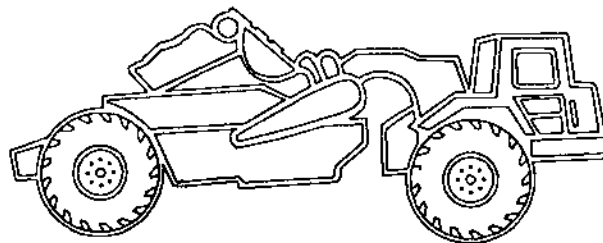

LEXINGTON GRANITE CO
LEXINGTON KY

STD5V065 .CMP

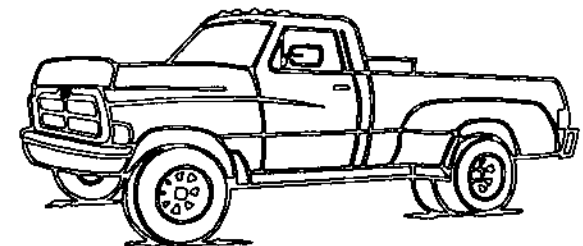

LEXINGTON GRANITE CO
LEXINGTON KY

STD5V066 .CMP

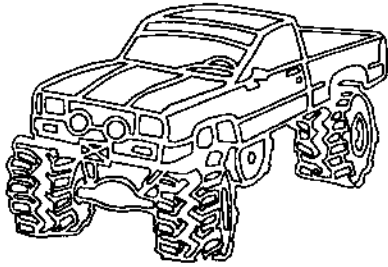

LEXINGTON GRANITE CO
LEXINGTON KY

STD5V067.CMP

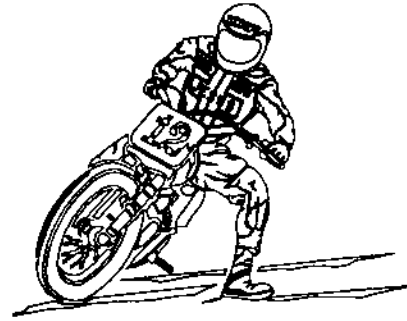

MASTERCRAFT MEMORIALS
RICHMOND IN

STD5V068.CMP

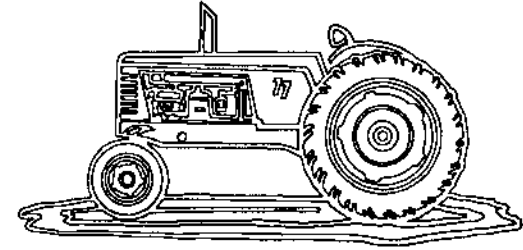

TROY MARBLE & GRANITE WORKS
TROY PA

STD5V069.CMP

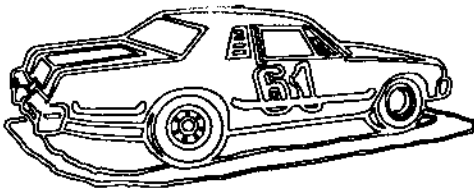

TROY MARBLE & GRANITE WORKS
TROY PA

STD5V070.CMP

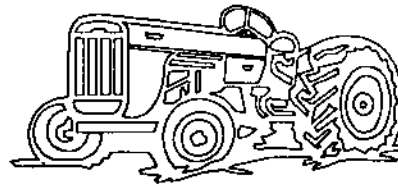

L. J. SERVICES
CHERRY VALLEY NY

STD5V071.CMP

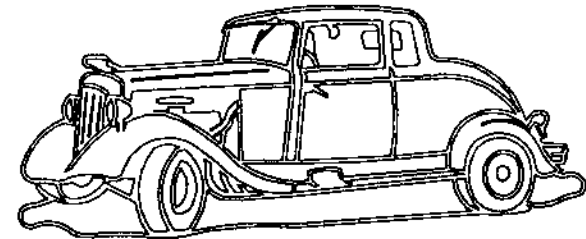

L. J. SERVICES
CHERRY VALLEY NY

STD5V072.CMP



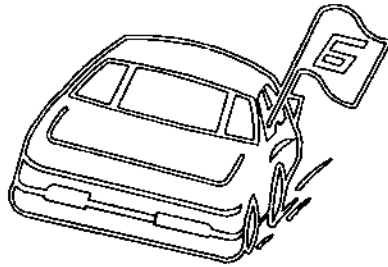

LANDMARK GRANITE CO
ELBERTON GA

STD5V073 .CMP

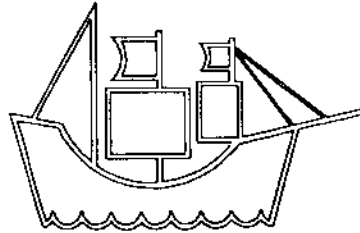

LANDMARK GRANITE CO
ELBERTON GA

STD5V074 .CMP

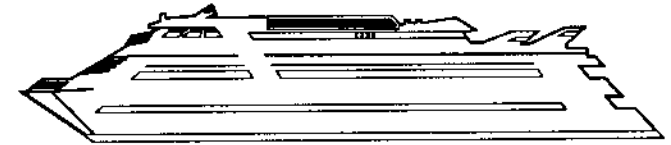

LANDMARK GRANITE CO
ELBERTON GA

STD5V075 .CMP

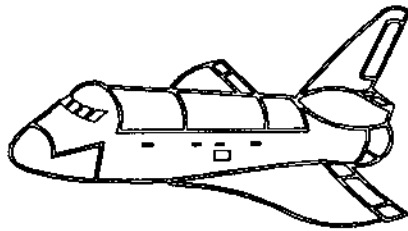

LANDMARK GRANITE CO
ELBERTON GA

STD5V076 .CMP

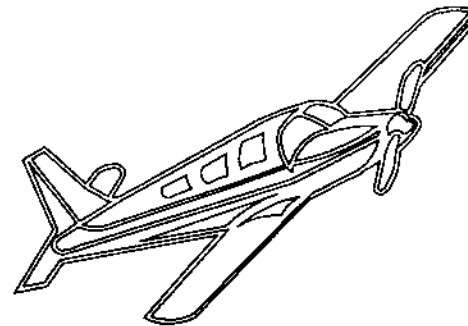

LANDMARK GRANITE CO
ELBERTON GA

STD5V077 .CMP

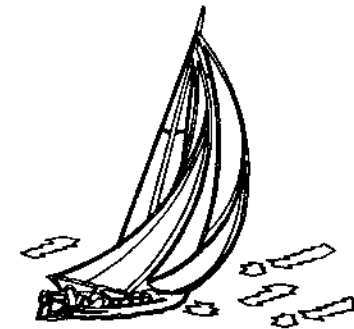

CARON GRANITE CO
PAWTUCKET RI

STD5V078 .CMP

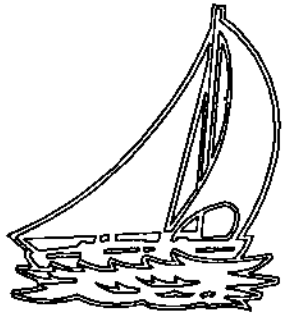

CARON GRANITE CO
PAWTUCKET RI

STD5V079 .CMP

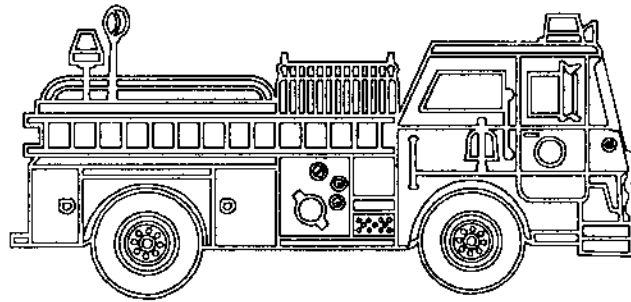

CARON GRANITE CO
PAWTUCKET RI

STD5V080 .CMP

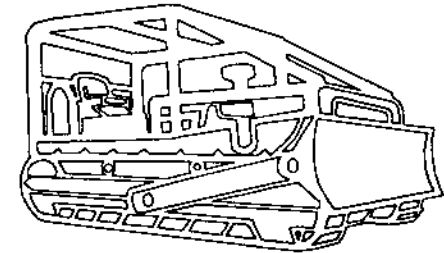

OREGON GRANITE CO
MEDFORD OR

STD5V081 .CMP



OREGON GRANITE CO
MEDFORD OR

STD5V082 .CMP

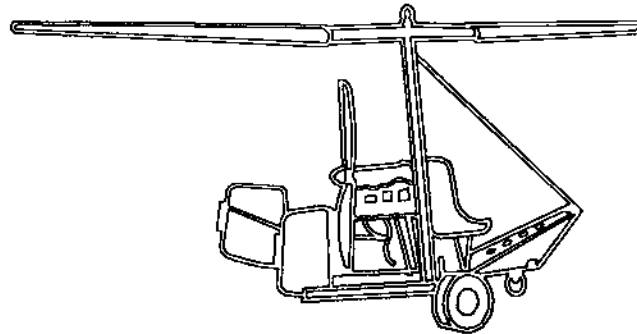

PEEBLES MONUMENT CO
PEEBLES OH

STD5V083 .CMP

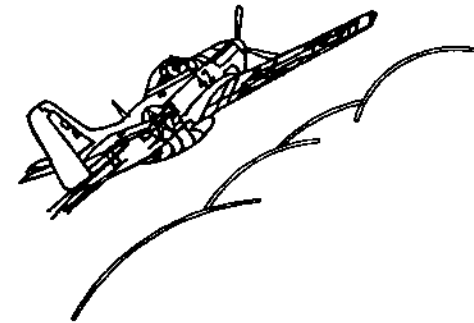

CHERRY VALLEY MEMORIALS
CHERRY VALLEY NY

STD5V084 .CMP

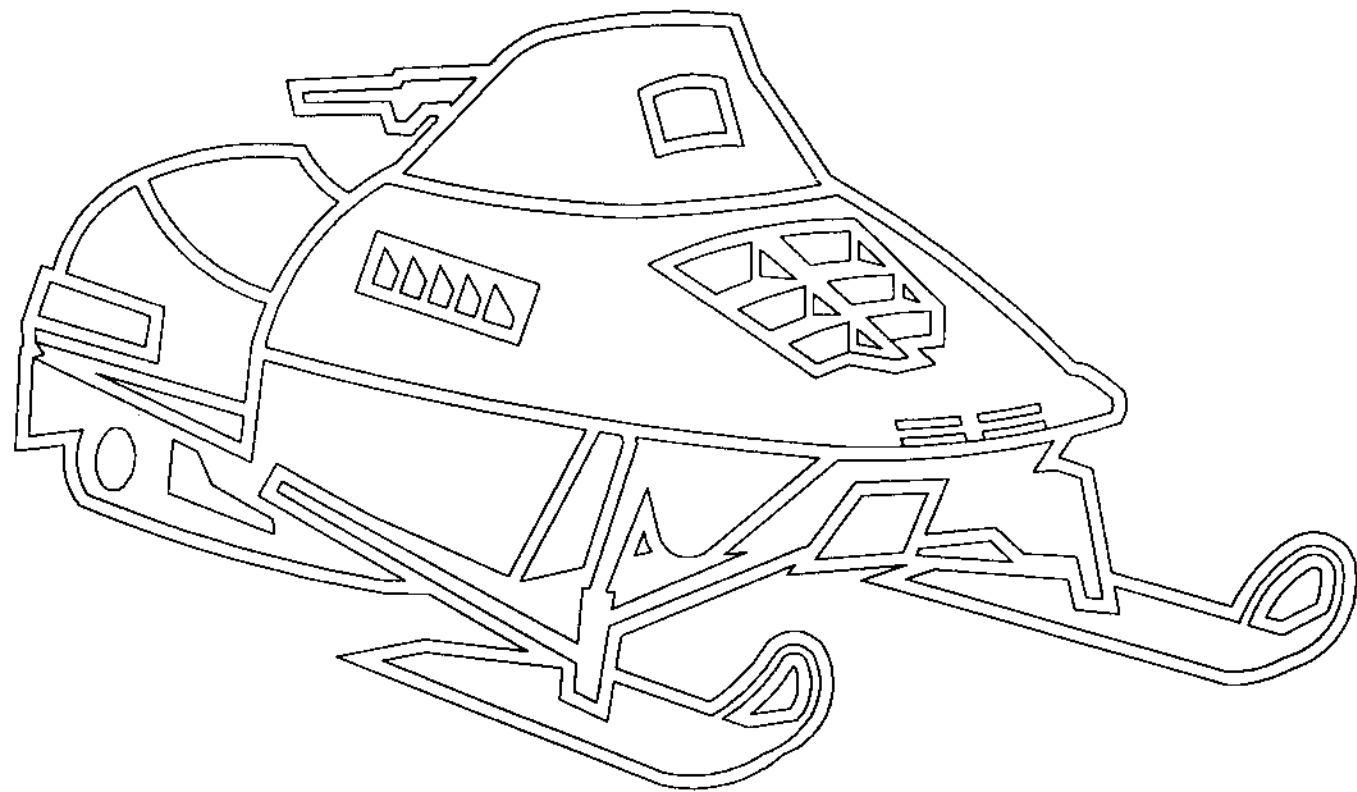

CHERRY VALLEY MEMORIALS

CHERRY VALLEY NY

STD5V085 . CMP

